



Assembly and Handling Precautions for the Nichia NLSW03A04A LED Modules

Light Emitting Diode

Table of Contents

1. Overview	2
2. Applicable Part Numbers	2
3. Storage.....	2
4. Directions for Use	3
5. Handling Precautions	4
6. Assembly Precautions	6
7. Cautions for Volatile Organic Compounds and Corrosive Gases.....	12
8. Thermal Design	13
9. Electrostatic Discharge (ESD).....	16
10. Eye Safety	17
11. Summary.....	17

The Nichia part numbers NLSW03A04A and NV3W470A within this document are merely Nichia's part numbers for those Nichia products and are not related nor bear resemblance to any other company's product that might bear a trademark.

1. Overview

This LED module (i.e. P/N: NLSW03A04A) is intended for use in digital micromirror device (DMD) systems¹. This LED module contains a discrete NV3W470A LED component; the emission area is optimal in size and shape for DMDs allowing for simple optical designs.

This application note provides the assembly and handling precautions for this LED module.

2. Applicable Part Numbers

This application note applies to the LED module shown in Table 1.

Table 1. Applicable LED Module

Part Number	NLSW03A04A
Appearance (Structure)	
Size (mm)	<p>36×22×(5.32)</p> <p>Note: The value in parentheses is for reference purposes only.</p>

3. Storage

3.1 Storage Conditions

Table 2 provides the required storage conditions before opening the moisture-proof bag.

Table 2. Storage Conditions

Conditions	Temperature	Humidity	Time
Before Opening the Moisture-proof Bag	≤30°C	≤90%RH	Within 1 Year from Delivery Date

¹ A DMD is a display device comprised of several hundred thousand to several millions of rotating microscopic mirrors (i.e. micromirrors) that are arranged in a rectangular array on an integrated circuit substrate. Each micromirror, whose size is approximately 10µm or more per side, corresponds a pixel of the display device. They rotate individually to switch the state to on/off. In a DMD system, a DMD receives the light emitted from a light source and then on-state micromirrors reflect the light. The light is projected through a lens to display images.

This LED module has metal parts (e.g. electrodes, plating, silver bonding material, bonding ribbons, solder joints, etc.). If those metal parts are exposed to a corrosive environment, it may cause them to tarnish causing issues. Once the moisture-proof bag is opened, the remaining unused LED modules must be stored in a hermetically sealed container. Nichia recommends placing them back to the original moisture-proof bag and reseal it.

3.2 Storage Environment

To avoid condensation, the LED modules must not be stored in areas where temperature and humidity fluctuate greatly. Also, ensure that the LED modules are not exposed to direct sunlight and/or an environment over a long period of time where the temperature is higher than normal room temperature and are not stored in a dusty environment.

4. Directions for Use

4.1 Absolute Maximum Ratings

Absolute maximum ratings of the LED module are the maximum values that must not be exceeded even for a short period of time. It must be ensured that the absolute maximum ratings are taken into consideration when designing a system/application using the LED module and will not be exceeded in the conditions/environments in which the LED module will actually be used even for a short period of time.

Table 3. Absolute Maximum Ratings for the NLSW03A04A LED Module

Item	Absolute Maximum Rating
Forward Current (I_F)	5500 mA
Surge Forward Current (I_{FS})	7000 mA
Allowable Reverse Current (I_R)	85 mA
Power Dissipation (P_D)	71 W
Operating Temperature (T_{opr})	-40~125 °C
Storage Temperature (T_{stg})	-40~125 °C
Junction Temperature (T_J)	150 °C

- Characteristics at $T_J = 25^\circ\text{C}$
- IFS conditions with pulse with $\leq 0.01\text{ms}$ and duty cycle $\leq 0.5\%$.

4.2 Operating Current

The LED component used within this LED module is designed to be operated at a forward current. The sorting current for this LED module is 5000mA; to stabilize the LED module characteristics while in use, Nichia recommends that the LED modules are operated at currents $\geq 10\%$ of the sorting current.

4.3 Other Directions

Ensure that no voltage is applied to the LED module in the forward/reverse direction while the LED module is off. If the LED modules are used in an environment where reverse voltages are applied to the LED modules continuously, it may cause electrochemical migration to occur causing the LED modules to be damaged. When not in use for a long period of time, the system's power should be turned off to ensure that there are no issues/damage.

If the LED modules are used for outdoor applications, ensure that necessary measures are taken (e.g. protecting the LED modules from water/salt damage and high humidity).

5. Handling Precautions

When handling the LED module, wear ESD gloves or use tweezers, etc. Do not handle the LED module with bare hands:

- this may contaminate the surface and have an effect on the optical characteristics,
- this may cause static electricity to build up leading to a malfunction (e.g. causing the LED module not to illuminate).

Do not touch the prohibited area shown in Figure 1 (i.e. the LED component, other components, and the black resin). This may cause the LED module malfunction (e.g. the LED module not to illuminate).

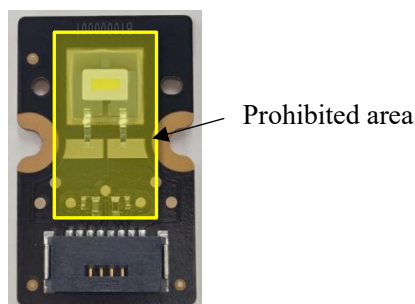
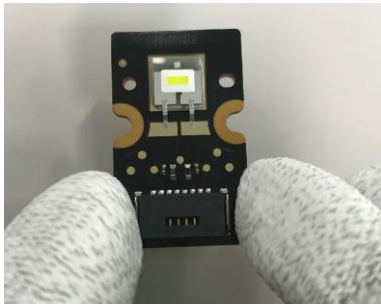

Figure 1. Prohibited Area

Grab/hold the LED module by the sides of the connector.

Do not apply an external force of $\geq 10.45\text{N}$ to the connector. This may cause the LED module to be damaged.

✓ Correct



Recommended handling

✗ Incorrect

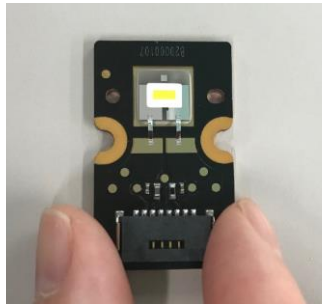

Handling with bare hands

✗ Incorrect

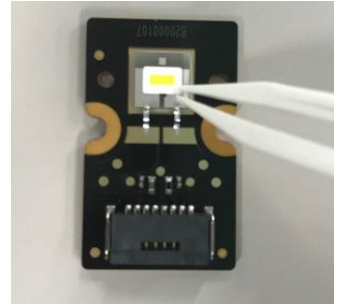

Touching the prohibited area

Figure 2. Correct/Incorrect Examples of Handling the LED Module

Do not drop the LED module; this may cause issues (e.g. causing the LED component to be damaged [e.g. scratch, chip, and/or delamination], the bonding ribbon to deform, and/or the electric connection to fail, etc.) resulting in adverse effect on the optical characteristics, a catastrophic failure (i.e. the LED module not to illuminate), etc.

Do not stack the LED modules; this may cause issues (e.g. causing the LED component to be damaged [e.g. scratch, chip, and/or delamination], the bonding ribbon to deform, and/or the electric connection to fail, etc.) resulting in adverse effect on the optical characteristics, a catastrophic failure (i.e. the LED module not to illuminate), etc.

✗ Incorrect



Figure 3. Do not drop the LED module

✗ Incorrect

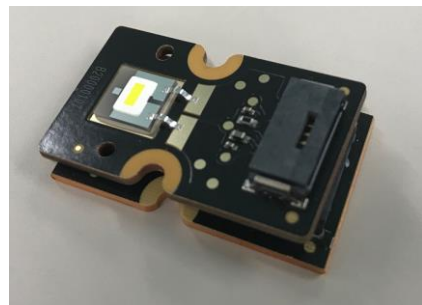

Figure 4. Do not stack the LED modules

6. Assembly Precautions

6.1 How to Attach the LED module to a Heatsink/Housing

6.1.1 Positioning

This LED module has two guide holes for positioning (i.e. a round hole and an elongated hole) on the sides of the emission area; see Figure 5. Ensure that the contact surface of the heatsink/housing (i.e. the plane that the LED module is attached to) has bosses of proper size in the proper places; see Figure 7 for the outline dimensions for the LED module. Nichia recommends that the tips of the bosses are chamfered (i.e. C edge) or corner rounded (i.e. R edge) to facilitate the attachment of the LED module to the heatsink/housing.

If the base of the boss is corner rounded with an R edge, ensure that the R edge does not prevent the boss and the guide hole from properly fitting causing the PCB to tilt and/or a gap to be made between the PCB and heatsink/housing; see Figure 6.

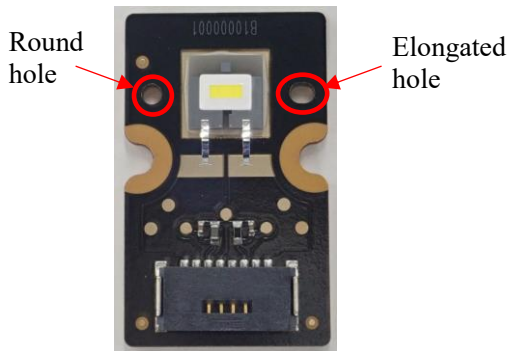

Figure 5. Guide Holes

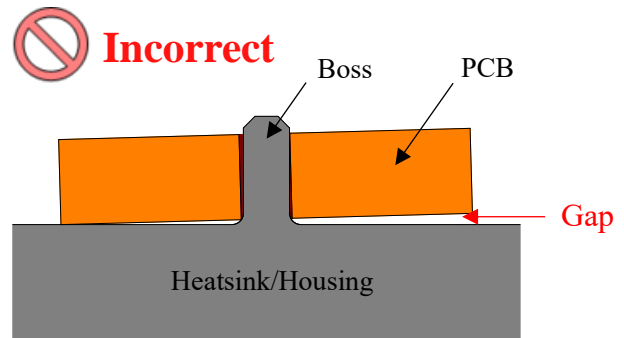

Figure 6. Example of an Incorrect Attachment due to the Edge of the Base of the Boss

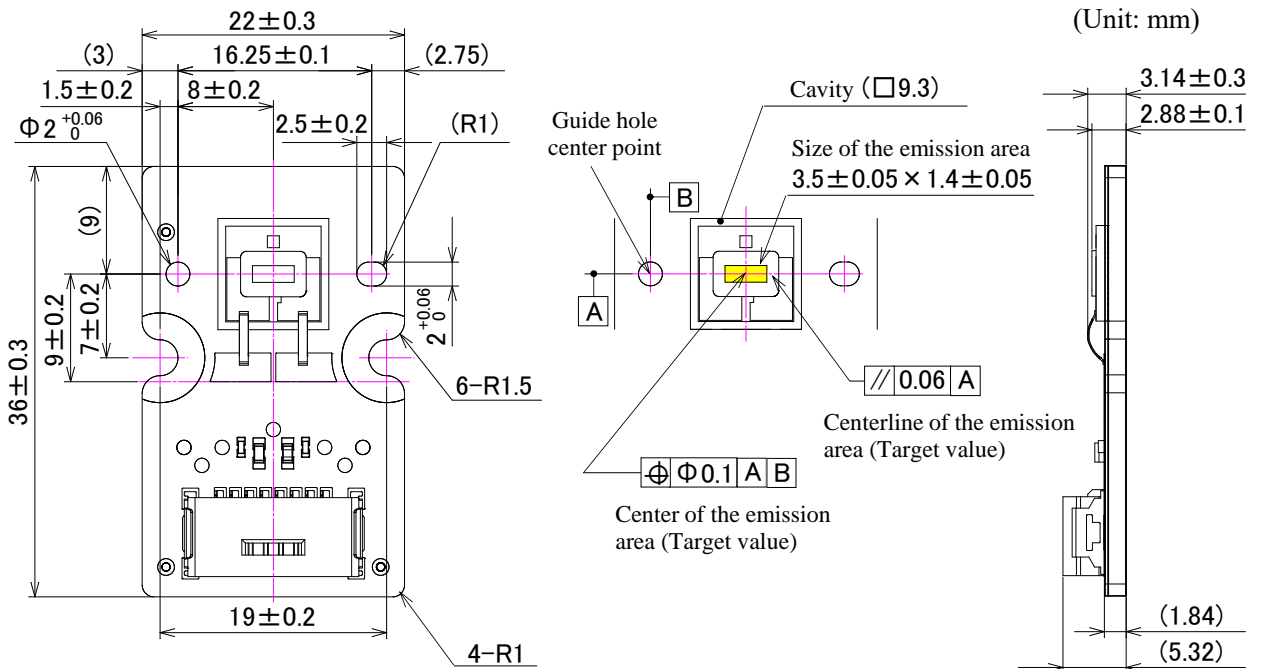

Figure 7. Outline Dimensions for the LED module

Figure 8 shows a reference image of an appropriate attachment of the bosses on the heatsink/housing to the guide holes of the LED module.

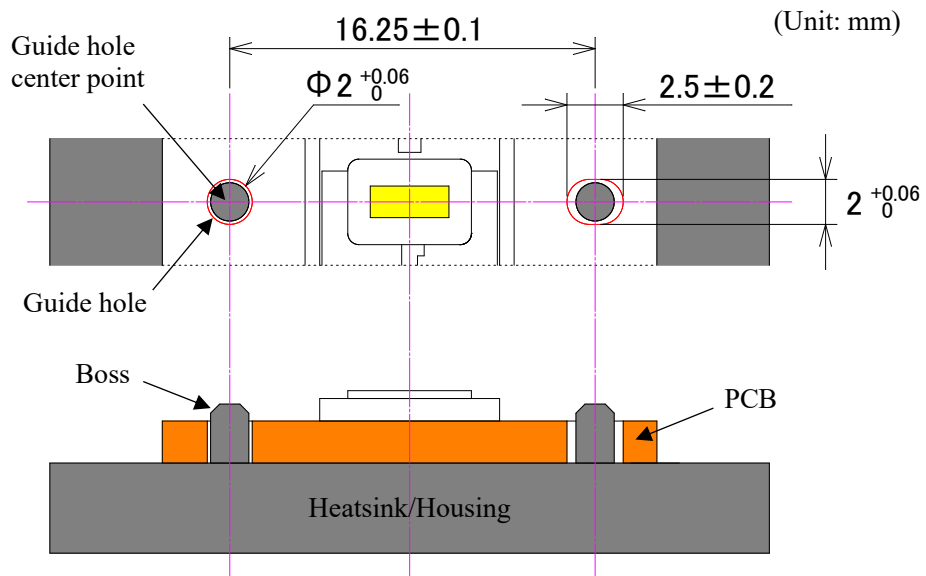

Figure 8. Reference Image of Properly Designed Bosses

6.1.2 Precautions for Attaching the LED module to a Heatsink/Housing

Attach the LED module to a heatsink/housing with two screws inserted in the places indicated in Figure 9. Ensure that appropriate screws (e.g. specifications, shape, and size) are selected taking into consideration the material for the contact surface, thickness of the heatsink/housing, etc.; refer to Table 4 and the outline dimensions provided in this application note. Select screws with a flat bearing surface (e.g. screws with a pan head, truss head, binding head, etc.); do not select screws with a tapered bearing surface (e.g. screws with a flat head, oval head, etc.).

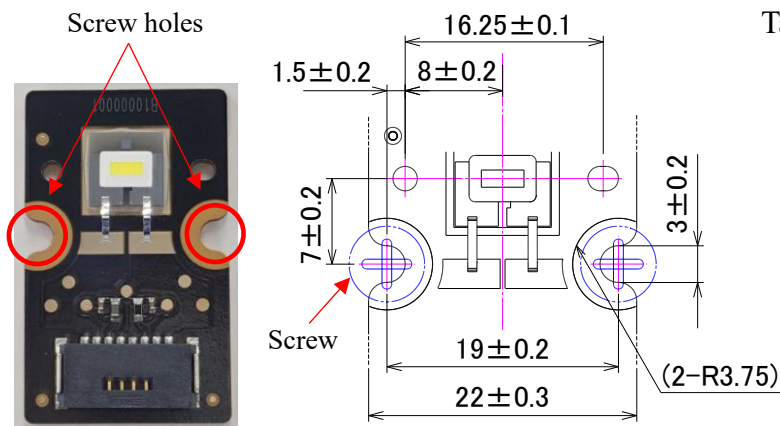

Figure 9. Where to Insert the Screws

Table 4. How to Attach the LED module to a Heatsink/Housing

Attachment method	Two screws
Recommended thermal interface material	Thermal grease (see 6.3)
Recommended size for the screw thread	M2.6
Reference size for the screw head	Φ4.5 ~ 6.5mm

When securing the LED module to a heatsink/housing, Nichia recommends that both of the screws are partially tightened, then fully tightened. Use an appropriate torque as per the recommended conditions for the screws being used. If an excessive torque is used, it may cause the LED module to deform, etc. leading to a malfunction (e.g. causing the LED module not to illuminate). Do not perform this securing process more than once.

Do not touch the LED component and other components when attaching the LED module to a heatsink/housing with screws.

6.2 Considerations for the Contact Surface and Thermal Interface Materials (TIMs)

The surface of the heatsink/housing to attach the LED module should be smooth and even (i.e. no hole/recess, burr/flash, etc.); ensure that the surface is leveled by machining and cleaned to remove any liquid, grease, contamination, etc. just before attaching the LED module to the heatsink/housing.

To increase the heat dissipation performance, use a thermal interface material (TIM) (i.e. a heat conductive material such as thermal grease, thermal sheets, etc.) between the LED module and heatsink/housing. Nichia recommends using thermal grease for better heat dissipation; Nichia does not recommend using a thermal sheet since it may cause the thermal resistance of the LED module to be significantly greater.

If the heatsink/housing has holes/recesses, screw holes, foreign materials, burrs/flash, etc. on the contact surface with the LED module, it may cause the heat from the LED module not to sufficiently transfer to the heatsink/housing. Figure 10 shows correct/incorrect examples of attaching the LED module to a heatsink/housing.

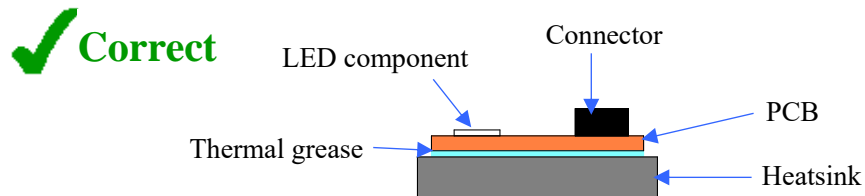

Heatsink with an even contact surface and proper amount of thermal grease

Incorrect

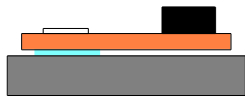

Insufficient thermal grease

Incorrect

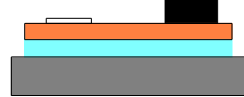

Excessively thick TIM

Incorrect



Heatsink with an uneven contact surface

Incorrect

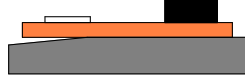

Heatsink with insufficient flatness for the contact surface

Incorrect

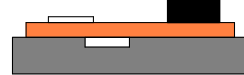

Heatsink with a hole/recess on the contact surface

Incorrect

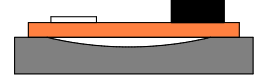

Heatsink with a curved contact surface

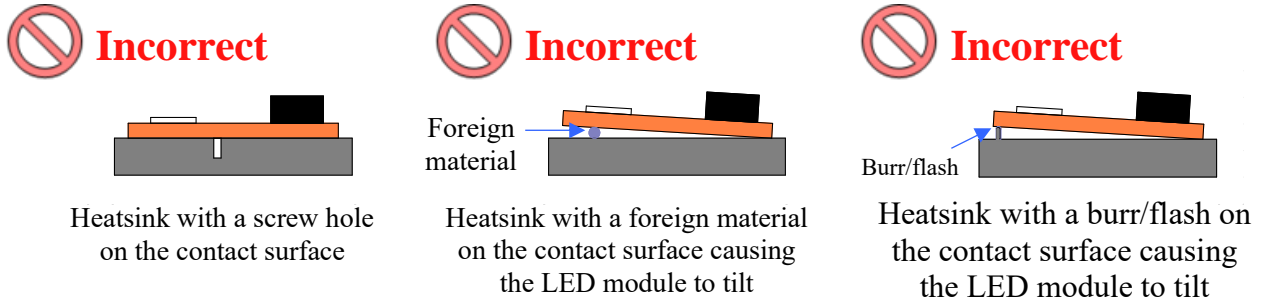

Figure 10. Correct/Incorrect Examples of Attaching the LED module to a Heatsink

6.3 Thermal Grease

When selecting thermal grease, consider its characteristics (i.e. thermal conductivity, operating temperature range, etc.) and the components it is made of to ensure that the chosen thermal grease is suitable for the chosen application. Nichia recommends the thermal grease manufactured by Shin-Etsu Chemical Co., Ltd. with the part number G-779 (thermal conductivity: 3.0W/m·K).

Ensure that thermal grease is applied to the proper area evenly and in an adequate amount (see Figure 11). The heat dissipation performance will be worse if the amount of thermal grease is insufficient. The heat dissipation performance will become significantly worse especially if no thermal grease is applied to the area on the back of the LED module where the LED component is located. Perform a sufficient verification with the chosen application to ensure that there are no issues with how the thermal grease is applied to the LED module.

If thermal grease has been applied incorrectly, the amount of change in the resistance value of the thermistor may become greater than it should be compared to the amount of the change in the input current; ensure that the relationship between the input current and thermistor's resistance is as designed.

If the chosen design uses multiple LED modules on a heatsink/housing, ensure that there is no significant difference in temperature between the LED modules.

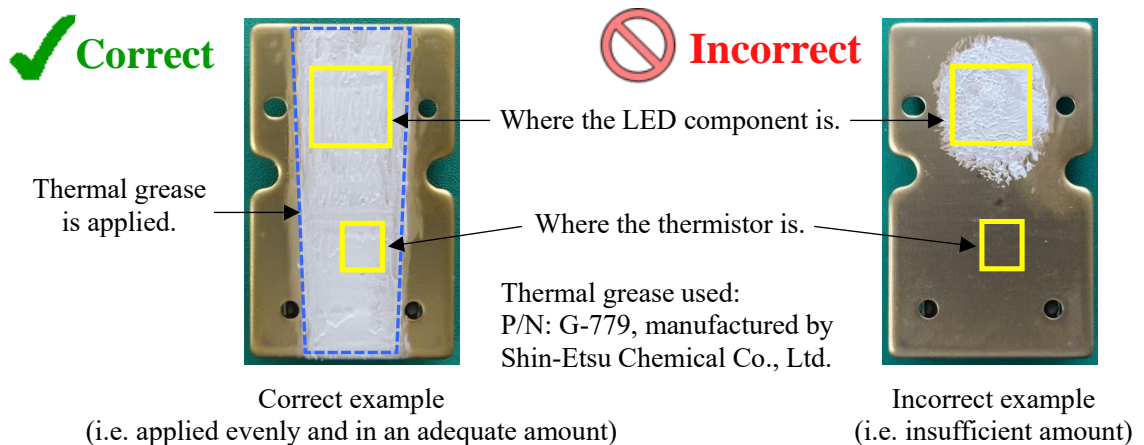

Figure 11. Correct/Incorrect Example of Applying Thermal Grease

6.4 How to Attach the Connectors

This LED module has a connector (manufactured by TE Connectivity [i.e. ERNI Electronics], part number: 474811) mounted on the PCB.

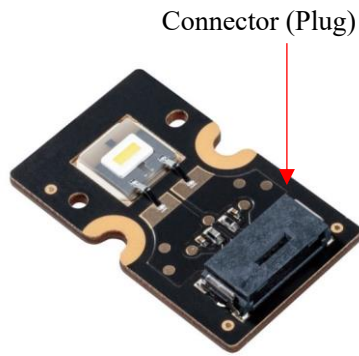
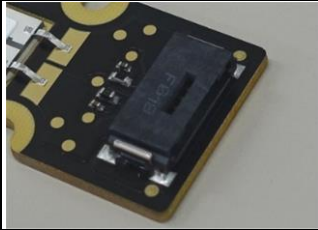



Figure 12. Connector of the LED module

Table 5. Part Numbers and Appearance for the Connectors

Connectors manufactured by TE Connectivity (i.e. ERNI Electronics)		
Type	Plug	Receptacle
P/N	474811	484083
Appearance		

During and after attaching a connector (i.e. receptacle) to the connector on the LED module (i.e. the plug), ensure that excessive external force is not applied to the plug; it may cause the plug to be damaged and/or removed from the PCB.

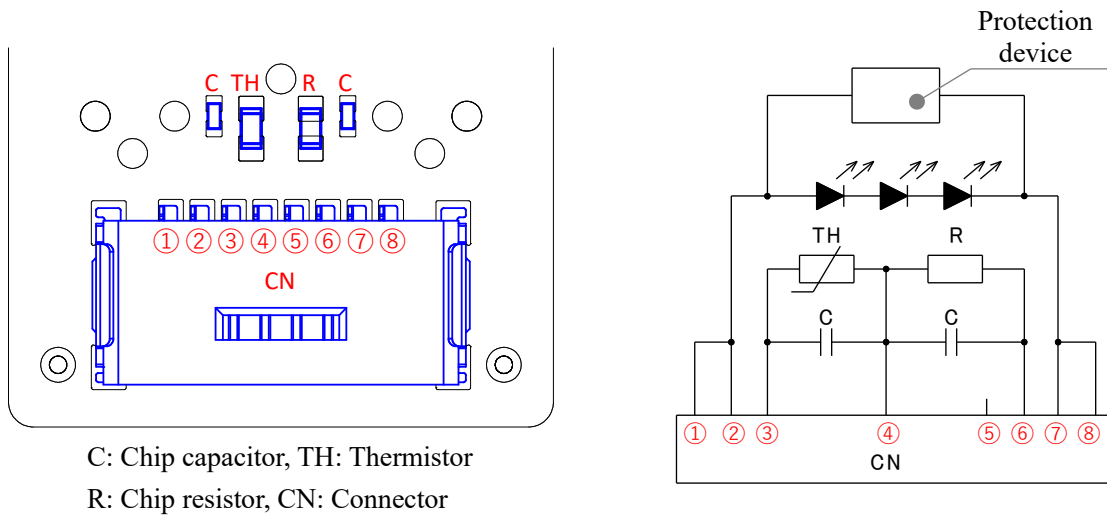
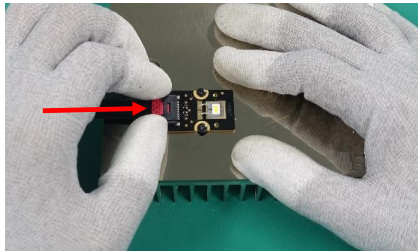

Figure 13. Pin Identification Numbers and Drive Circuit

When attaching the connectors (i.e. inserting a receptacle into the plug), keep the LED module stable (e.g. this attachment process is carried out on a table); hold the receptacle close to the insertion area (i.e. do not hold it by the cable at a distance away from the insertion area) and insert the receptacle straight and horizontally into the plug.

✓ Correct



The LED module is stable on a table. The receptacle is held at the insertion area and inserted into the plug horizontally.

✗ Incorrect

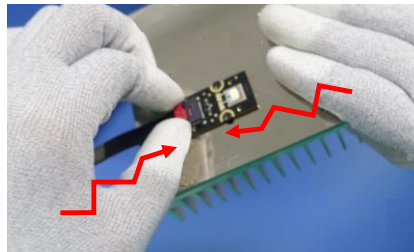

The hands/LED module are not stable.

✗ Incorrect

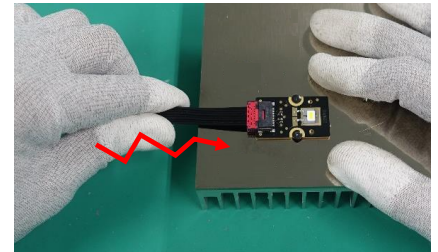

The receptacle is held by the cable at a distance away from the insertion area.

Figure 14. Correct/Incorrect Examples of Attaching the Connectors

After inserting a receptacle into the plug, check that the connectors are properly attached by ensuring that the stopper of the receptacle can be seen through the window on the top surface of the plug and that there is no gap between the connectors at the attached area.

✓ Correct

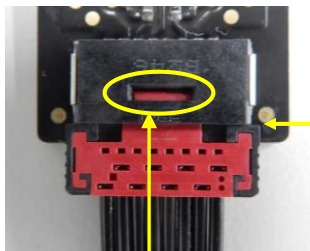

Able to completely see the stopper.

✗ Incorrect

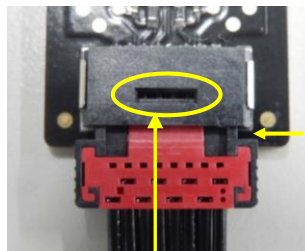

Cannot see the stopper at all.

✗ Incorrect

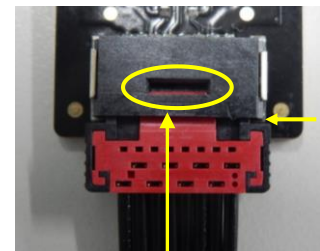

Only able to partially see the stopper.

Figure 15. Correct/Incorrect Examples of How the Connectors are Attached

6.5 Securing the Cable of the Receptacle

After attaching the connectors, ensure that external force is not applied to the connectors; Nichia recommends securing the cable of the receptacle to the heatsink/housing. If excessive external force is applied to the connectors, the plug may be damaged and/or removed from the PCB.

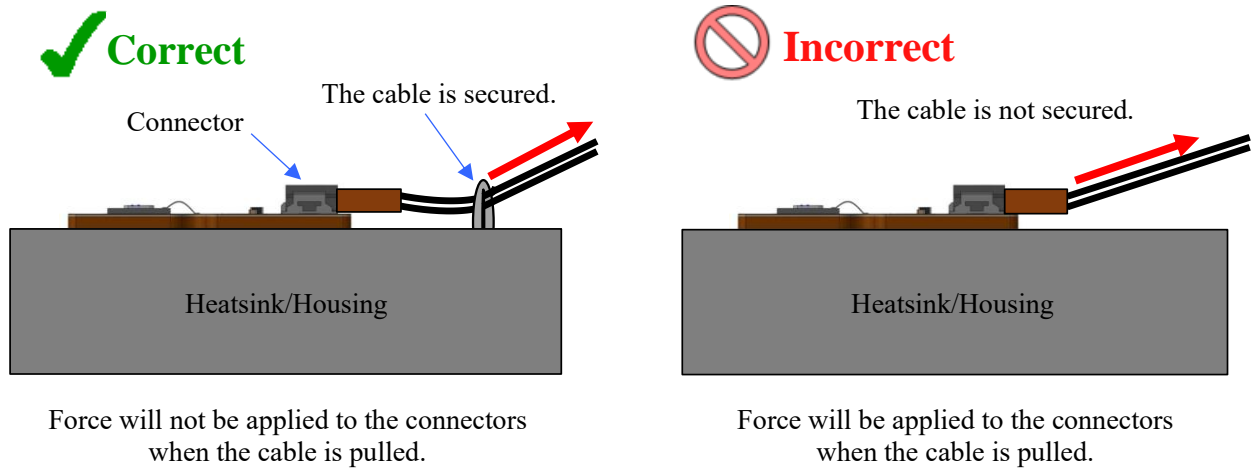

Figure 16. Correct/Incorrect Example of Managing the Cable after Attaching the Connectors

6.6 Detaching the connectors

Once the connectors are attached, they are secured to each other with a snap-fit. If the connectors are detached without disengaging the snap-fit correctly, it may damage the connectors; use a specially designed tool² to disengage the snap-fit and ensure that the connectors are not damaged.

7. Cautions for Volatile Organic Compounds and Corrosive Gases

7.1 Volatile Organic Compounds (VOCs)

Materials present around the LED modules (e.g. housing, gasket/seal, adhesive, secondary lens, lens cover, grease, etc.) may contain volatile organic compounds (VOCs); the VOCs that have been released from them may penetrate the encapsulating resin of the LED module. If the LED modules are being used in a hermetically/near-hermetically sealed environment, VOCs can discolor after being exposed to heat and/or photon energy and it may greatly reduce the LED module light output and/or cause a color shift. Perform a light-up test of the chosen application for optical evaluation to ensure that there are no issues before use.

Ventilating the environment may improve the reduction in light output and/or color shift that may occur due to VOCs.

² For detailed information regarding the tool to detach the connectors, consult the manufacturer of the connectors (i.e. TE Connectivity).

7.2 Corrosive Gases

To prevent substances/gases from affecting the plated surfaces, adhesive, etc. of the LED modules, ensure that the parts/materials used with the LED modules (e.g. gasket/seal, adhesive, etc.) in the same assembly/system do not release corrosive gases (i.e. the parts/materials do not contain sulfur, halogens, etc.). If the plated surfaces, adhesive, etc. becomes corroded, it may cause issues (e.g. electrical connection failures).

If a gasket/seal is used, silicone rubber gaskets/seals are recommended; ensure that this use of silicone does not result in issues (e.g. electrical connection failures) caused by low molecular weight volatile siloxane.

8. Thermal Design

8.1 Thermal Design Considerations

When using the LED modules, ensure that proper thermal management is provided to efficiently dissipate the heat from the chip of the LED component; the Absolute Maximum Rating Junction Temperature (T_J) must not be exceeded. The increase in the temperature of the chip while in operation may vary depending on the material of the heatsink being used, with/without a cooling fan, the type of thermal grease being used, how the thermal grease is applied, etc. Ensure that when using the LED modules for the chosen application, heat is not concentrated in an area and the Absolute Maximum Rating T_J is not exceeded under any circumstances. The operating current should be determined by considering the temperature conditions surrounding the LED module (T_A). Ensure that when operating the LED modules, proper measures are taken to dissipate the heat.

8.2 How to Estimate the Junction Temperature (T_J)

The following equations can be used to calculate the LED component temperature (T_J) once the saturation temperature at the junction has been reached.

$$T_J = T_{TH} + R_{\theta JTH} \times W$$

T_J : LED Component Junction Temperature ($^{\circ}C$)

T_{TH} : Thermistor Temperature ($^{\circ}C$)

$R_{\theta JTH}$: Thermal Resistance from Junction to T_{TH} Measurement Point (i.e. thermistor) ($^{\circ}C/W$)

Note: The $R_{\theta JTH}$ will vary depending on the LED module operating current (see Table 6).

W : Input Power when the saturation temperature at the junction has been reached ($I_F \times V_F$) (W)

I_F = Forward Current (A), V_F = Forward Voltage (V)

Table 6. LED Module Operating Current and Thermal Resistance

LED Module Operating Current, I_F (A)	Thermal Resistance, $R_{\theta JTH}$ ($^{\circ}C/W$)
5.0	1.64
4.5	1.68
4.0	1.71
3.5	1.74
3.0	1.77
2.5	1.78

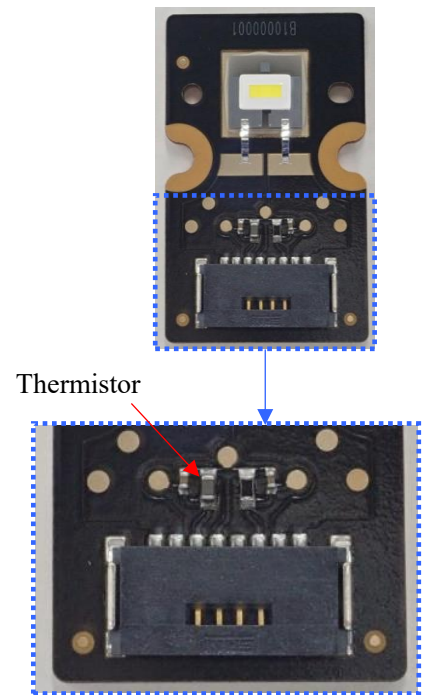

Figure 17. Thermistor

8.3 How to Determine the Thermistor Temperature (T_{TH})

In this section, Nichia describes the procedures for obtaining the thermistor temperature (T_{TH}) by applying a very low pulse current to the thermistor and measuring the voltage drop across the thermistor to convert it to the resistance of the thermistor (R_{TH}).

1. Apply a very low pulse current to the thermistor.
If the current is too large, the self-heating of the thermistor may become large causing the thermistor not to detect the ambient temperature properly; the recommended current is 0.1mA.
2. Measure the voltage drop across the thermistor and calculate the R_{TH} (Ω) using Ohm's law.
Ohm's law: $R_{TH} (\Omega) = V (V)/I (A)$
3. Using Table 8 in section 8.4, choose the T_{TH} ($^{\circ}C$) for the calculated R_{TH} (Ω) value.

8.4 Thermistor Used within the LED Module

The thermistor used within this LED module is an NTC thermistor manufactured by Panasonic Corporation (P/N: ERTJ1VG103FM).

Table 7. Thermistor Used within the LED Module

Manufacturer	Part Number	Resistance (at 25°C)	B Constant ³
Panasonic Corporation	ERTJ1VG103FM	10KΩ ± 1%	3435K ± 1%

Table 8. Thermistor's Resistance vs. Temperature Characteristics

T _{TH} (°C)	R _{TH} (Ω)	T _{TH} (°C)	R _{TH} (Ω)	T _{TH} (°C)	R _{TH} (Ω)	T _{TH} (°C)	R _{TH} (Ω)	T _{TH} (°C)	R _{TH} (Ω)
0	28704	28	8916	56	3379	71	2144	86	1413
1	27417	29	8585	57	3274	72	2083	87	1376
2	26197	30	8269	58	3172	73	2024	88	1340
3	25039	31	7967	59	3075	74	1967	89	1305
4	23940	32	7678	60	2981	75	1912	90	1272
5	22897	33	7400	61	2890	76	1858	91	1239
6	21906	34	7135	62	2803	77	1807	92	1208
7	20964	35	6881	63	2719	78	1757	93	1177
8	20070	36	6637	64	2638	79	1709	94	1147
9	19219	37	6403	65	2559	80	1662	95	1118
10	18410	38	6179	66	2484	81	1617	96	1091
11	17641	39	5965	67	2411	82	1574	97	1063
12	16909	40	5759	68	2341	83	1532	98	1037
13	16212	41	5561	69	2273	84	1491	99	1012
14	15548	42	5372	70	2207	85	1451	100	987
15	14916	43	5189						
16	14313	44	5015						
17	13739	45	4847						
18	13192	46	4686						
19	12669	47	4531						
20	12171	48	4382						
21	11696	49	4239						
22	11242	50	4101						
23	10809	51	3969						
24	10395	52	3842						
25	10000	53	3719						
26	9622	54	3601						
27	9261	55	3488						

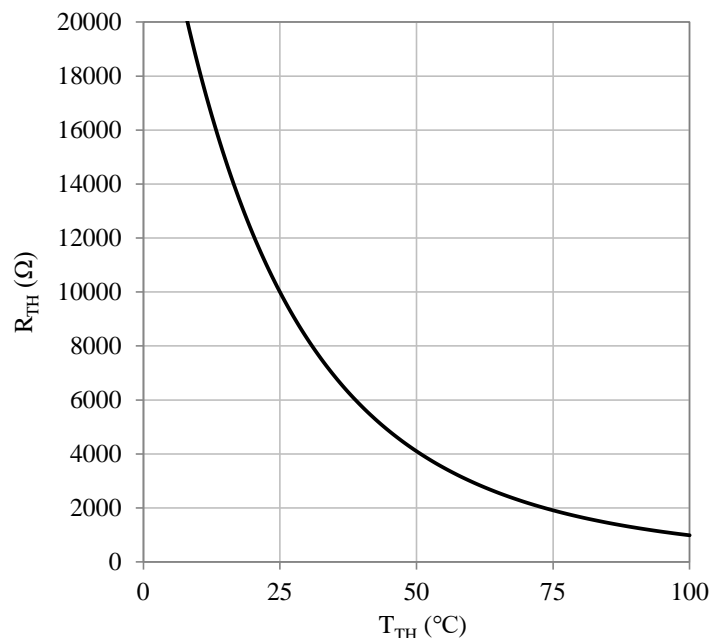

Figure 18. Thermistor's Resistance vs. Temperature

³ A physical property that shows the degree of the thermistor's sensitivity to temperature changes.

9. Electrostatic Discharge (ESD)

9.1 Measures against ESD

The LED component used within this LED module is sensitive to transient excessive voltages (e.g. ESD, lightning surge). If this excessive voltage occurs in the circuit, it may cause the LED module to be damaged causing issues (e.g. the LED module to become dimmer or not to illuminate [i.e. catastrophic failure]). Ensure that when handling the LED modules, necessary measures are taken to protect them from an ESD discharge. The following examples are recommended measures to eliminate the charge:

- Grounded wrist strap, ESD footwear, clothes, and floors
- Grounded workstation equipment and tools
- ESD table/shelf mat made of conductive materials

Ensure that all necessary measures are taken to prevent the LED modules from being exposed to transient excessive voltages (e.g. ESD, lightning surge):

- tools, jigs, and machines that are used are properly grounded
- appropriate ESD materials/equipment are used in the work area
- the system/assembly is designed to provide ESD protection for the LED modules

9.2 Measures for when the Tool/Equipment Used is an Insulator

If the tool/equipment used is an insulator (e.g. glass cover, plastic, etc.), ensure that necessary measures have been taken to protect the LED modules from transient excessive voltages (e.g. ESD). The following examples are recommended measures to eliminate the charge:

- Dissipating static charge with conductive materials
- Preventing charge generation with moisture
- Neutralizing the charge with ionizers

9.3 How to Detect LED Modules that have been Damaged by ESD

To detect if an LED module was damaged by transient excess voltages (i.e. an ESD event during the system's assembly process), perform a characteristics inspection (e.g. forward voltage measurement, light-up test) at low current ($\leq 1\text{mA}$). If the LED module is damaged by transient excess voltages (e.g. ESD), it will cause:

- the Forward Voltage (V_F) to decrease
- the LED module not to illuminate at a low current

Table 9 shows the failure criteria for this LED module.

Table 9. Failure Criteria

I_F	Failure criteria for V_F
0.5mA	< 6.0V

10. Eye Safety

In 2006, the International Electrical Commission (IEC) published IEC 62471:2006 Photobiological safety of lamps and lamp systems, which added LEDs in its scope. On the other hand, the IEC 60825-1:2007 laser safety standard removed LEDs from its scope. However, be advised that some countries and regions have adopted standards based on the IEC laser safety standard IEC 60825-1:2011/2001, which still includes LEDs in its scope. Most of Nichia's LEDs can be classified as belonging into either the Exempt Group or Risk Group 1. High-power LEDs, that emit light containing blue wavelengths, may be classified as Risk Group 2. Proceed with caution when viewing directly any LEDs driven at high current or viewing LEDs with optical instruments which may greatly increase the damage to human eyes.

Viewing a flashing light may cause eye discomfort. When incorporating the LED module into chosen application, be careful to avoid adverse effects on the human body caused by light stimulation.

11. Summary

This LED module needs to be handled and assembled in a proper manner to obtain the required characteristics and the reliability. Follow the cautions/suggestions detailed in this application note to ensure that the LED module is used properly.

In addition, perform sufficient verification with the conditions/environments in which the chosen application containing the LED module will actually be used to ensure that the characteristics and/or the reliability for the LED module are not adversely affected before selecting other components to be used with the LED module.

Disclaimer

This application note is a controlled document of Nichia Corporation (Nichia) published to provide technical information/data for reference purposes only. By using this application note, the user agrees to the following:

- This application note has been prepared solely for reference on the subject matters incorporated within it and Nichia makes no guarantee that customers will see the same results for their chosen application.
- The information/data contained herein are only typical examples of performances and/or applications for the product. Nichia does not provide any guarantees or grant any license under or immunity from any intellectual property rights or other rights held by Nichia or third parties.
- Nichia makes no representation or warranty, express or implied, as to the accuracy, completeness or usefulness of any information contained herein. In addition, Nichia shall not be liable for any damages or losses arising out of exploiting, using, or downloading or otherwise this document, or any other acts associated with this document.
- The content of this application note may be changed without any prior or subsequent notice.
- Copyrights and all other rights regarding the content of this document are reserved by Nichia or the right holders who have permitted Nichia to use the content. Without prior written consent of Nichia, republication, reproduction, and/or redistribution of the content of this document in any form or by any means, whether in whole or in part, including modifications or derivative works hereof, is strictly prohibited.