



Assembly Precautions for the Nichia E11 Series LEDs

Table of contents

1. <u>LED Outline Dimensions/Tape Dimensions</u>	2
2. <u>Handling Precautions</u>	3
3. <u>Design Recommendations for Optimal Amount of Solder</u>	4
4. <u>Precautions for solder joint</u>	5
5. <u>Precautions for Setting Up a Pick-and-Place Machine/Nozzle</u>	6-9
6. <u>Precautions When Reflow Soldering</u>	9
7. <u>Evaluation of the Effect of Solder Volume</u>	10-11
8. <u>Evaluation of Self-Alignment Performance</u>	12-13

The part number NFSWE11A in this document is the part number of our product, and does not have any relevance or similarity to other companies' products that may have trademark rights.

This document contains tentative information, Nichia may change the contents without notice.

1. LED Outline Dimensions/Tape Dimensions

Table 1. Product Specifications

Part Number	NFSWE11A														
LED	<p>光学的中心位置 Location of the optical center</p> <p>Cathode Anode</p>	<table border="1"> <thead> <tr> <th>Color Rank</th> <th>CRI rank</th> <th>H</th> </tr> </thead> <tbody> <tr> <td rowspan="2">2700K-4000K</td> <td>R8000</td> <td>0.3</td> </tr> <tr> <td>R9050</td> <td>0.35</td> </tr> <tr> <td rowspan="2">sm50x</td> <td>R8000</td> <td>0.27</td> </tr> <tr> <td>R9050</td> <td>0.3</td> </tr> </tbody> </table> <p>[unit: mm, Tolerance: ±0.1mm]</p>	Color Rank	CRI rank	H	2700K-4000K	R8000	0.3	R9050	0.35	sm50x	R8000	0.27	R9050	0.3
Color Rank	CRI rank	H													
2700K-4000K	R8000	0.3													
	R9050	0.35													
sm50x	R8000	0.27													
	R9050	0.3													
Embossed Carrier Tape	<p>(0.02 クロスバー凹部) (0.02 Crossbar Recess)</p> <p>Cathode</p> <p>Reel Size: 14,000 LEDs</p> <p>[unit: mm]</p>														

This document contains tentative information, Nichia may change the contents without notice.

2. Handling Precautions

Handling with bare hands

- Do not handle the LEDs with bare hands:
- this may contaminate the LED surface and have an effect on the optical characteristics,
 - this may cause the LED to deform and/or the wire to break causing a catastrophic failure (i.e. the LED not to illuminate),
 - the lead frame may cause injuries when the LED is handled with bare hands.

Handling with tweezers

- Do not handle the LEDs with tweezers.
- this may cause the LED to deform and/or the wire to break causing a catastrophic failure (i.e. the LED not to illuminate),

ESD Precautions

LEDs are sensitive to transient excessive voltages (e.g. ESD, lightning surge). If this excessive voltage occurs in the circuit, it may cause the LED to be damaged causing issues (e.g. the LED to have a reduction in the radiant flux or not to illuminate [i.e. catastrophic failure]). When handling the LEDs, ensure that necessary measures have been taken to protect them from transient excess voltages. Refer to the applicable specification for more details.

Stacking assembled PCBs together

Do not stack assembled PCBs together. Otherwise, it may cause damage to the resin (e.g. cut, scratch, chip, crack, delamination and deformation) and the internal connection to fail causing a catastrophic failure (i.e. the LED not to illuminate).

Baking

The storage/packaging requirements for the Nichia E11 Series LEDs are comparable to JEDEC Moisture Sensitivity Level (MSL) 2a or equivalent. Nichia used IPC/JEDEC STD-020 as a reference to rate the MSL of this LED. Since baking is not guaranteed for the Nichia E11 Series LEDs, once the moisture-proof aluminum bag is opened ensure that soldering is completed within the storage times detailed in the applicable specification.

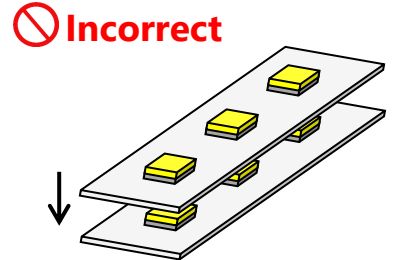
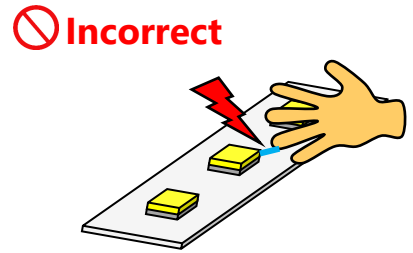

Figure 1. Example of Improper handling

Table 2. Storage/Baking Conditions

Conditions		Temperature	Humidity	Time
Storage	Before Opening Aluminum Bag	≤ 30°C	≤ 90% RH	Within 1 Year from Delivery Date
	After Opening Aluminum Bag	≤ 30°C	≤ 70% RH	≤ 4 weeks

This document contains tentative information, Nichia may change the contents without notice.

3. Design Recommendations for Optimal Amount of Solder

Soldering Pad Pattern/Metal Solder Stencil Aperture

Table 3. Recommended Soldering Pad Pattern/Metal Solder Stencil Aperture

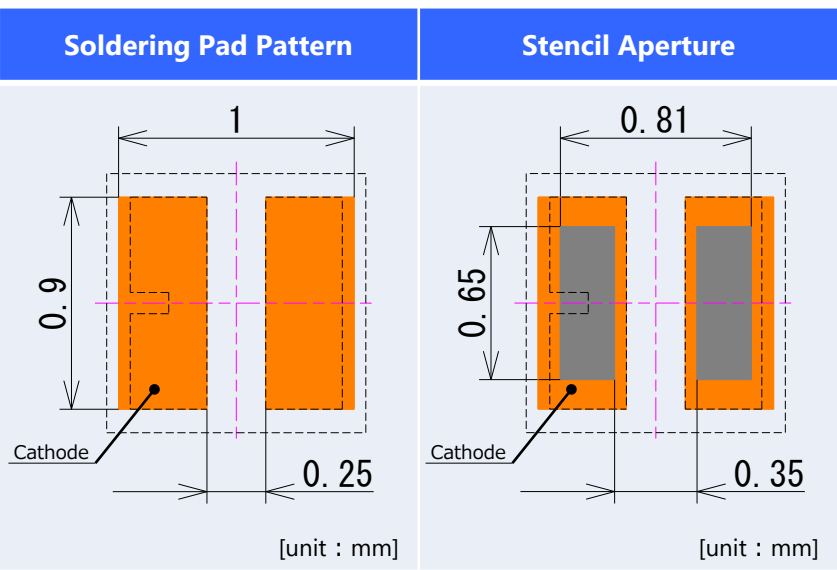

Table 4. Recommended Solder/Metal Solder Stencil Conditions

Item	Recommended Condition
Solder Stencil Thickness	100 [μm]
Solder Paste	Sn-3.0Ag-0.5Cu

- ... LED outline
- Soldering Pad Pattern
- Stencil Aperture

- When considering a pad pattern other than the recommended one above, do not change the pad pattern gap distance of 0.25 mm. Poor solder joints may affect reliability and performance.

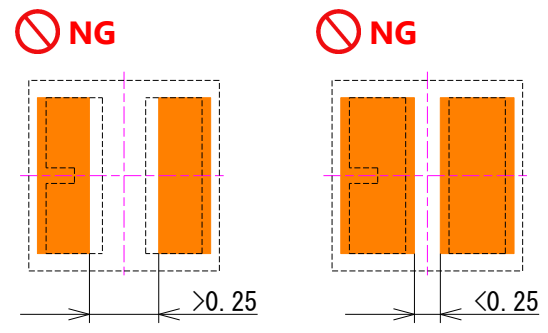

Figure 2. Non-recommended Pad Pattern

This document contains tentative information, Nichia may change the contents without notice.

4. Precautions for solder joint

4-1. Electrode and Heat-dissipation

The electrodes are expanded for the purpose of improving mounting performance. The electrodes need to be securely soldered to the copper pattern. Poor solder joint on the electrodes may negative impact reliability. Make sure the **considerable** area of electrodes are soldered to the copper pattern for best performance.

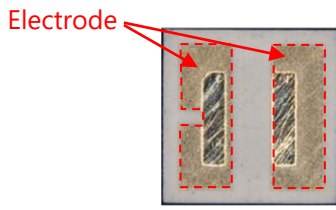

Figure 3. Electrode appearance

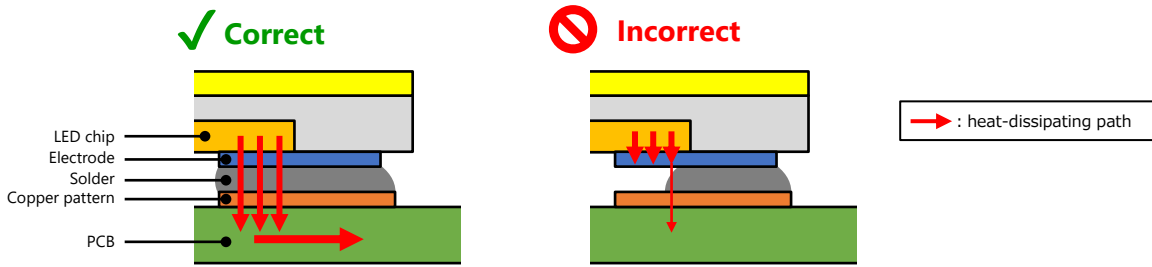

Figure 4. Heat dissipation by soldering

4-2. Solder Joint Ratio

Solder joint area of 75% or more of the electrode area is recommended. Soldering conditions is evaluated by X-ray inspection.

$$\text{Solder Joint Ratio [\%]} = \text{Solder Joint Area}^1 / \text{Electrode Area}$$

No soldering defects that affect performance and reliability were detected under Nichia's recommended conditions. Although, make sure the soldering area is sufficient under the customer's mounting conditions.

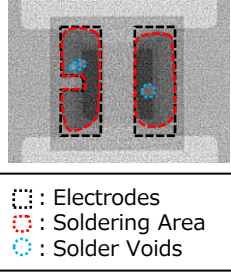

Figure 5. Example X-ray image

Note:
¹ Solder joint area does not include solder void area.

5. Precautions for Setting Up a Pick-and-Place Machine/Nozzle

Table 5. Cautions/Suggestions for setting up equipment

Item	Recommended Conditions/Specifications	Cautions/Suggestions
Pick-and-place machine ²	Modular mounter	
Pick-and-place nozzle	Smaller than the LED(1.1mm×1.1mm)	See "Pick-and-Place Nozzle" on Page 7 for the details.
Tape-and-reel feeder	Electrical (motorized) feeder Tape width: 8mm Feed length: 2mm	See "Tape-and-Reel Feeder" on Page 7 for the details.
Nozzle height for pick-up operations	Edge of the embossed carrier tape pocket.	See "Recommended Nozzle Height for Pick-up Operations" on Page 8 for the details.
Nozzle height for placement operations (i.e. placement depth)	0.2mm for placement depth	See "Recommended Nozzle Height for Placement Operations (Placement Depth)" on Page 8 for the details.
Imaging-based Automatic Inspection	Using the electrode as a reference is recommended to locate the center of the LED.	See "Imaging-based Automatic Inspection" on Page 9 for the details.

Note:
² The recommended conditions/specifications above have been determined under the following verification conditions:

- Pick-and-place machine (modular mounter):
- YS100 High-Speed General-Purpose Modular (manufactured by Yamaha Motor Co., Ltd.)

This document contains tentative information, Nichia may change the contents without notice.

5-1. Pick-and-Place Nozzle

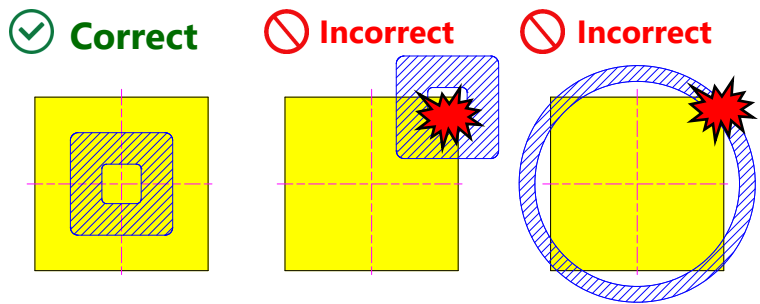

Figure 6. Example of Nozzle Dimensions

- Use a nozzle that is smaller than the product's outline dimensions (1.1 mm x 1.1 mm) and pick it up via the top surface.
- When using the nozzle that is larger than the outline dimensions or if the pick-up position is displaced, the product may be chipped or tilted during pick-up.

5-2. Tape-and-Reel Feeder

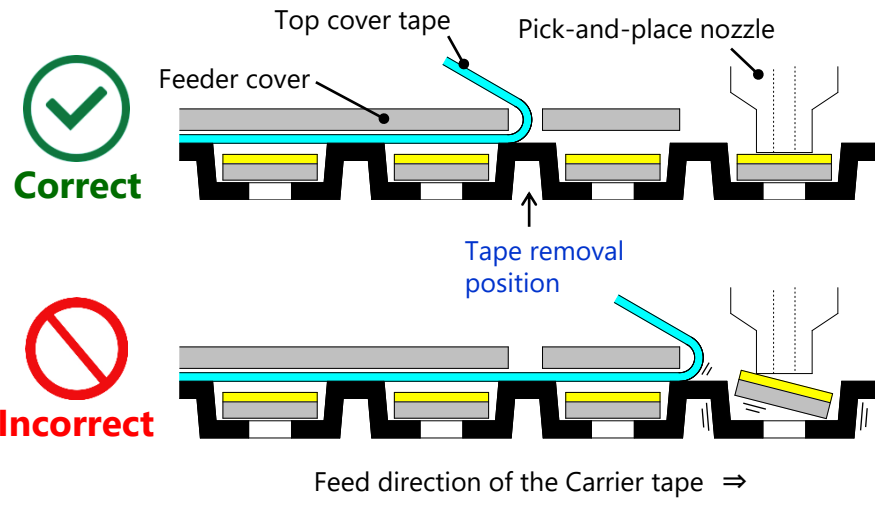

Figure 7. Examples of Top Cover Tape Removal Positions

- Recommended setting for the tape-and-reel feeder.
Tape width: 8mm
Feed length: 2mm
- Use a tape-and-reel feeder that ensures it does not create excessive vibrations causing assembly issues. Example: Electrical (motorized) feeder
- If the LED position within the tape pocket is not stable when the pick-up occurs, slow down the tape-and-reel feeder speed.
- The recommended top cover tape removal position is one LED away from the target LED. (See the Figure 7)
 - If the top cover tape is removed just before suction occurs, the operation may not be stable due to the vibration resulting from the tape removal. However, depending on the machine, it may be more stable to remove just before suction occurs, this should be checked and the proper removal position verified prior to beginning production.

This document contains tentative information, Nichia may change the contents without notice.

5-3. Recommended Nozzle Height for Pick-up Operations

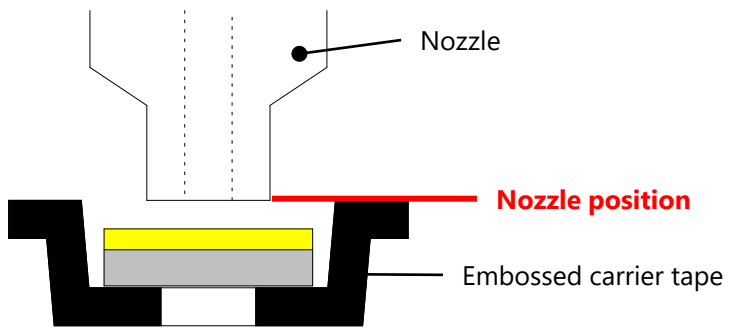

Figure 8. Recommended Nozzle Height for Pick-up Operations

5-4. Recommended Nozzle Height for Placement Operations (Placement Depth)

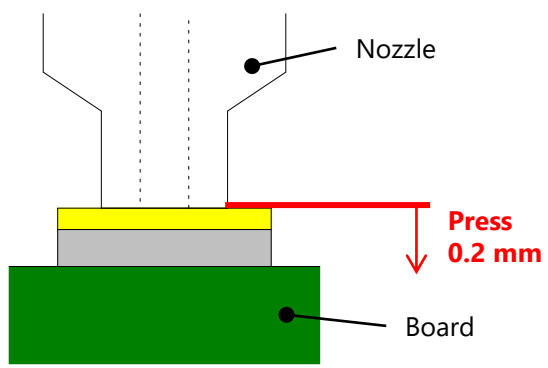

Figure 9. Recommended Nozzle Height for Placement (Placement Depth)

- Ensure that the nozzle only goes down to the top edge of the tape pocket and does not directly come into contact with the LED.
Note: The reference level for the nozzle setting is at the top edge of the tape pocket.
- The recommended nozzle height for pick-up operations has been determined by Nichia under the verification conditions and may not function as expected with some other pick-and-place machines. If the pick-up operations are unstable even with using the recommended nozzle height, adjust the nozzle height appropriate for the pick-and-place machine being used.
 - If the pick point of the nozzle is too high,
 - it may cause insufficient suction power leading to picking errors (e.g. the nozzle's failure to pick/lift the LED into the air, incorrect picking causing the LED to tilt when in the air).
 - If the pick point of the nozzle is too low,
 - it may cause issues (e.g. causing the embossed carrier tape to shake, causing the tape pocket to deform) leading to picking failure and/or damage to the LED.
- After the LED is mounted onto solder paste on the PCB, the nozzle should further press the LED 0.2mm into the PCB.
 - If the release point of the nozzle is too high,
 - it may cause placement issues (e.g. the LED to stick to the nozzle after placement, the LED to become soldered to the PCB in a tilted position, etc.).
 - If the release point of the nozzle is too low,
 - excessive forces may be applied to the LED during placement and it may cause the LED to become damaged.

This document contains tentative information, Nichia may change the contents without notice.

5-5. Imaging-based Automatic Inspection

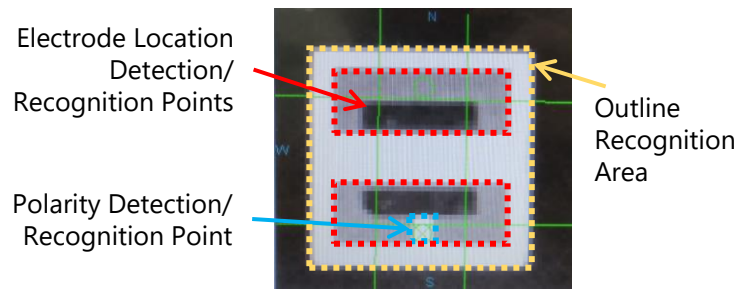

Figure 10. Recommended reference points to detect, recognize, or locate the polarity/electrodes

- Nichia recommends using the electrodes as a reference to locate the center of the LED.
- If the imaging device has trouble detecting/recognizing the electrodes due to the uniqueness of the electrode pattern, adjust it to detect/recognize the outer portions of the electrodes (i.e. the areas circled in red in Figure 10 to the left).
- If an automatic polarity detector is used for the LEDs, set up the imaging device to detect the empty space between the anode and cathode electrodes (i.e. Polarity Detection/Recognition Point in Figure 10 to the left). In the example in Figure 5, the equipment measures the brightness of the empty space against the threshold to locate the electrodes and/or determine the polarity.
- If it is still difficult to recognize the electrodes, it is possible to instead use the outline of the product (i.e. the area noted in yellow Figure 10 to the left) as the detection/recognition area. The issue with using this option is that it may not be possible to determine the polarity.

6. Precautions When Reflow Soldering

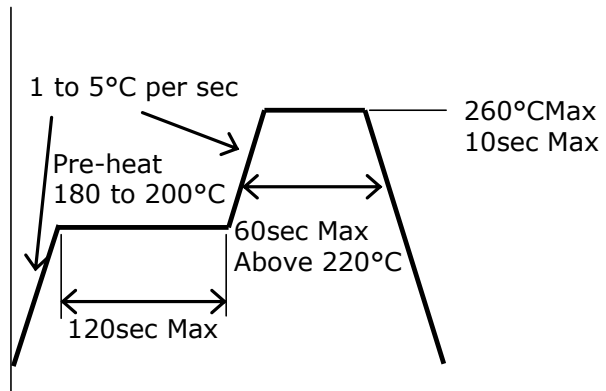

Figure 11. Recommended Reflow Soldering Condition (Lead-free Solder)

- Reflow soldering must not be performed more than twice.
- Using the recommended reflow soldering conditions (See Figure 11 to the left) as a reference, modify if necessary, the recommended reflow conditions specified by the manufacturer of the solder paste being used.

Note:
To ensure that these reflow conditions have no negative effect on the LEDs, perform sufficient verification prior to use.
- When cooling the LEDs from the peak temperature a gradual cooling slope is recommended; do not cool the LEDs rapidly.
- During reflow soldering, the heat and atmosphere in the reflow oven may cause the optical characteristics to degrade. In particular, reflow soldering performed with an air atmosphere may have a greater negative effect on the optical characteristics than if a nitrogen atmosphere is used; Nichia recommends using a nitrogen reflow atmosphere.

This document contains tentative information, Nichia may change the contents without notice.

7. Evaluation of the Effect of Solder Volume

7-1. Evaluation Method/Conditions

The effect of solder volume on the workmanship of the reflow-soldered LEDs was evaluated using nine different evaluation configurations (i.e. three aperture ratios, three thicknesses) to control the amount of solder paste.

Table 6. Evaluation stencil configurations

Thickness \ Aperture ratio	43%	52% (Nichia's Recommendation)	62%
80μm			
100μm (Nichia's Recommendation)			
120μm			

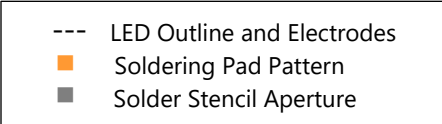

Aperture Ratio =
Stencil Aperture Area / Electrode Area

Sample size: 160 LEDs for each condition

7-2. Evaluation Results (x,y direction)

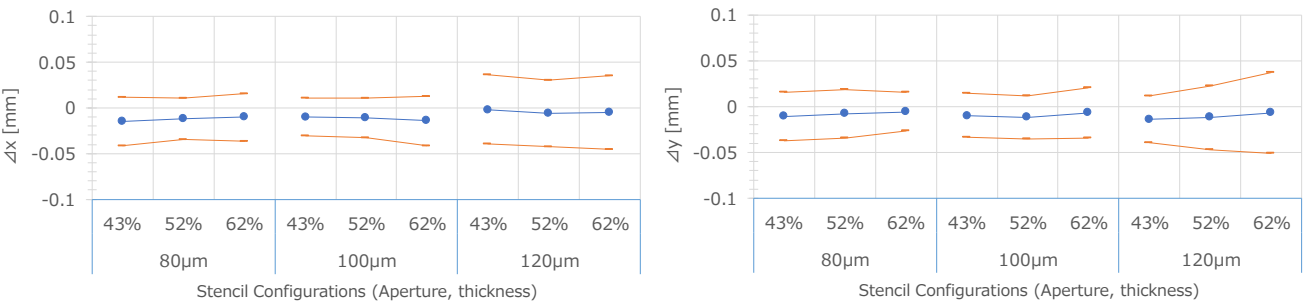
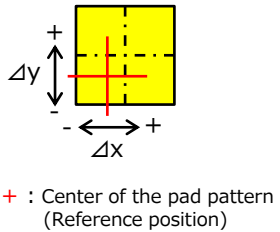

Figure 12. Evaluation Result (Δx,y)

- The variation from the reference position increased as the amount of solder paste increased.

This document contains tentative information, Nichia may change the contents without notice.

7-3. Evaluation Results (Rotation)

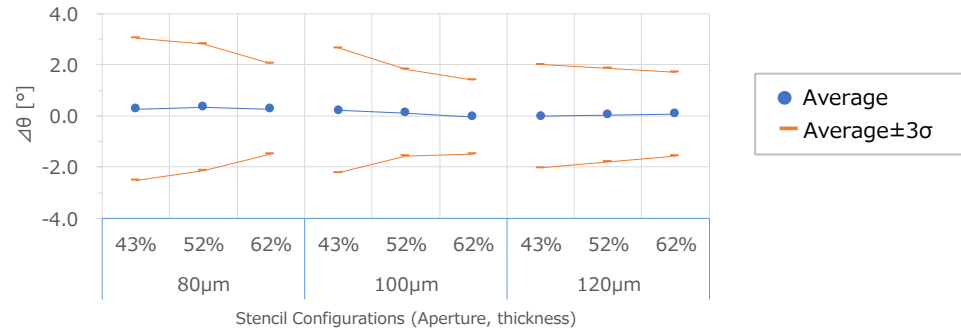
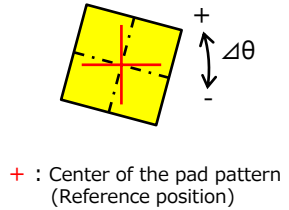

Figure 13. Evaluation Result ($\Delta\theta$)

- The variation from the reference angle decreased as the amount of solder paste increased.

7-4. Evaluation Results (z direction)

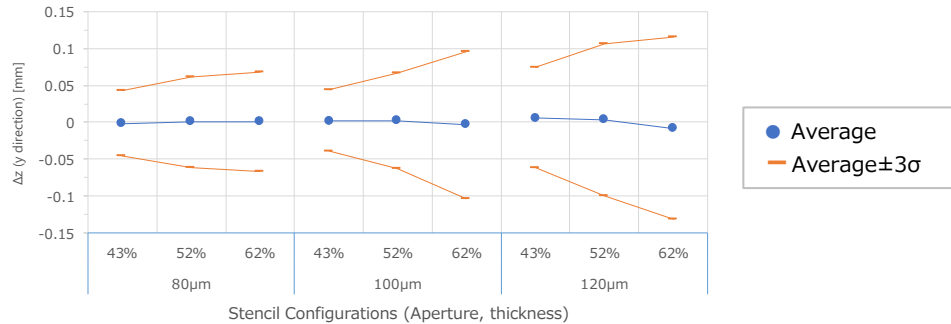
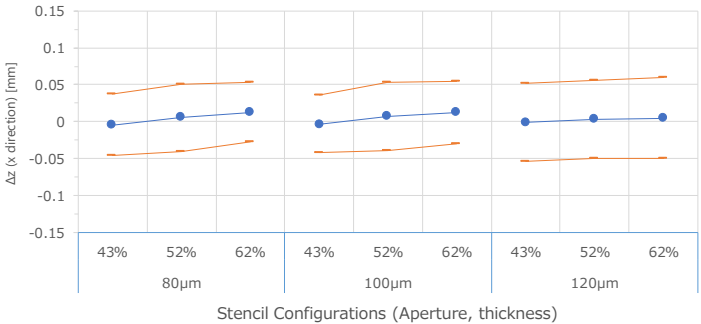

Figure 14. Evaluation Result (Δz)

- x direction: There is almost no difference depending on the amount of solder paste.
- y direction: The amount of LED tilt increased as the amount of solder paste increased.

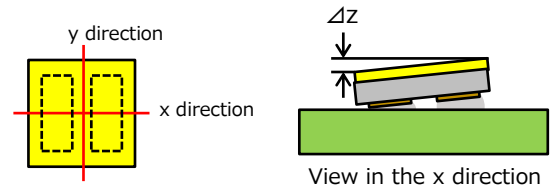

Figure 15. Evaluation direction

This document contains tentative information, Nichia may change the contents without notice.

8. Evaluation of Self-Alignment Performance

8-1. Evaluation Method/Conditions

The self-alignment performance of the reflow-soldered LEDs was evaluated using the evaluation conditions shown in Table 6. Sample size: 16 LEDs for each condition

8-2. Evaluation Results (Parallel misalignment)

Parallel Deviation Condition
 $\Delta x, y = 0.1\text{mm}$

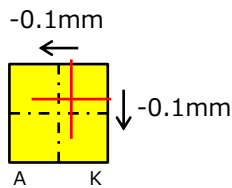

+ : Center of the pad pattern
(Reference position)

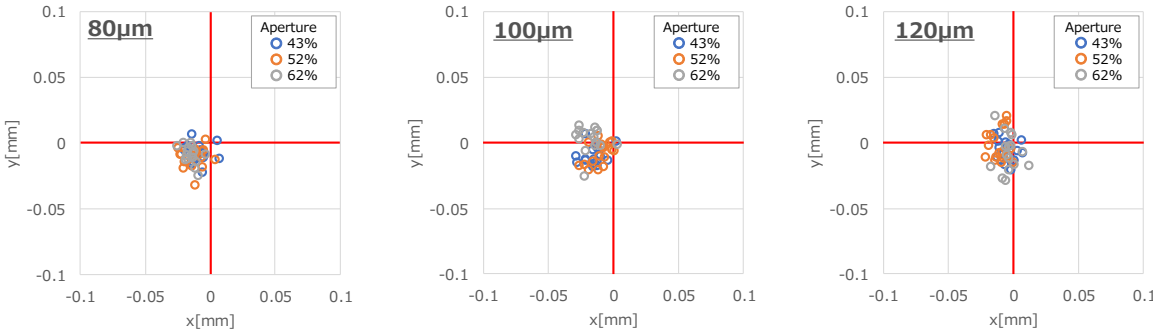
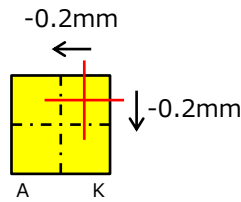

Figure 16. Evaluation Result ($\Delta x, y = 0.1\text{mm}$)

Parallel Deviation Condition
 $\Delta x, y = 0.2\text{mm}$



+ : Center of the pad pattern
(Reference position)

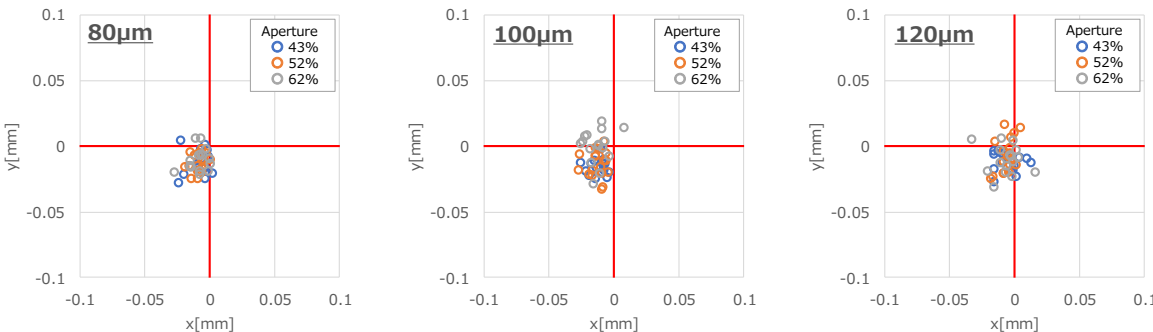

Figure 17. Evaluation Result ($\Delta x, y = 0.2\text{mm}$)

- Almost all the LEDs moved back to the reference position by themselves during soldering, there are no issues with the self-alignment performance.

This document contains tentative information, Nichia may change the contents without notice.

8-3. Evaluation Results (Angular misalignment)

Angular Deviation Condition
 $\Delta\theta = 5^\circ$

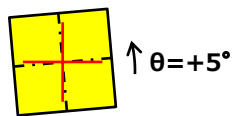

+ : Center of the pad pattern
 (Reference position)

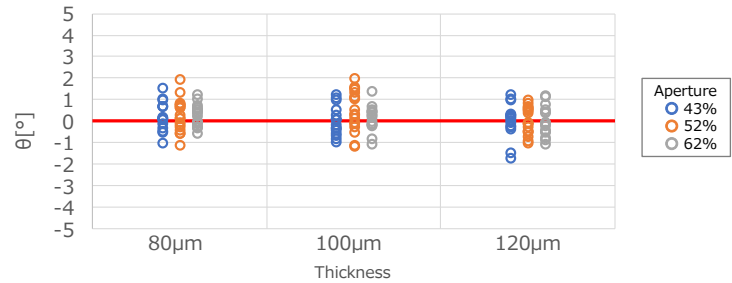
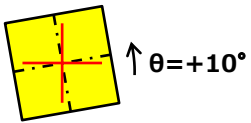

Figure 18. Evaluation Result ($\Delta\theta=5^\circ$)

Angular Deviation Condition
 $\Delta\theta = 10^\circ$



+ : Center of the pad pattern
 (Reference position)

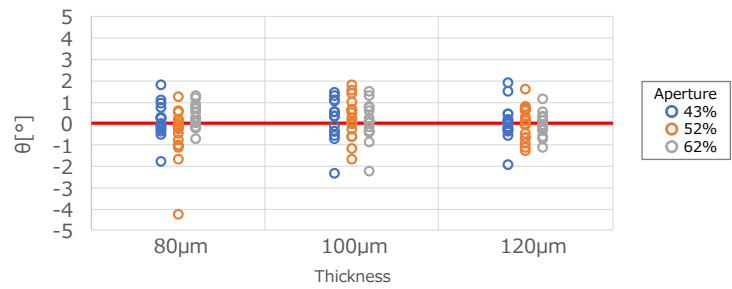
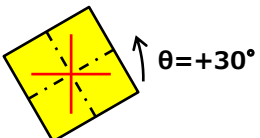

Figure 19. Evaluation Result ($\Delta\theta=10^\circ$)

Angular Deviation Condition
 $\Delta\theta = 30^\circ$



+ : Center of the pad pattern
 (Reference position)

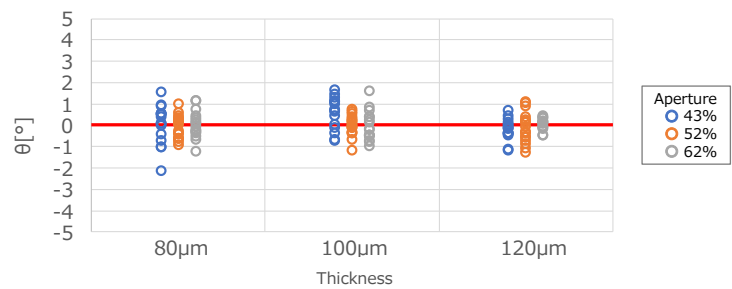

Figure 20. Evaluation Result ($\Delta\theta=30^\circ$)

- Almost all the LEDs moved back to the reference angle by themselves during soldering, there are no issues with the self-alignment performance.

This document contains tentative information, Nichia may change the contents without notice.

Disclaimer

This application note is a controlled document of Nichia Corporation (Nichia) published to provide technical information/data for reference purposes only. By using this application note, the user agrees to the following:

- This application note has been prepared solely for reference on the subject matters incorporated within it and Nichia makes no guarantee that customers will see the same results for their chosen application.
- The information/data contained herein are only typical examples of performances and/or applications for the product. Nichia does not provide any guarantees or grant any license under or immunity from any intellectual property rights or other rights held by Nichia or third parties.
- Nichia makes no representation or warranty, express or implied, as to the accuracy, completeness or usefulness of any information contained herein. In addition, Nichia shall not be liable for any damages or losses arising out of exploiting, using, or downloading or otherwise this document, or any other acts associated with this document.
- The content of this application note may be changed without any prior or subsequent notice.
- Copyrights and all other rights regarding the content of this document are reserved by Nichia or the right holders who have permitted Nichia to use the content. Without prior written consent of Nichia, republication, reproduction, and/or redistribution of the content of this document in any form or by any means, whether in whole or in part, including modifications or derivative works hereof, is strictly prohibited.

NICHIA CORPORATION 491 Oka, Kaminaka-Cho, Anan-Shi,
TOKUSHIMA 774-8601, JAPAN
<http://www.nichia.co.jp> Phone: +81-884-22-2311 Fax: +81-884-21-0148

This document contains tentative information, Nichia may change the contents without notice.