



# Assembly Precautions for the Nichia 119 or 219 Series LEDs

## Table of contents

1. LED Outline Dimensions/Tape Dimensions . . . . . 2-5
2. Handling Precautions . . . . . 6
3. Design Recommendations for Optimal Amount of Solder . . . . . 7-8
4. Precautions for Setting Up a Pick-and-Place Machine/Nozzle . . . . . 9-12
5. Precautions When Reflow Soldering . . . . . 13

The part number NVSW119C, NVSL119C, NVSW119D, NVSW119F, NVSW219C, NVSL219C, NVSW219D and NVSW219F in this document are the part number of our product, and do not have any relevance or similarity to other companies' products that may have trademark rights.

This document contains tentative information, Nichia may change the contents without notice.

# 1. LED Outline Dimensions(2 Terminals)/Tape Dimensions

Table 1. NVSW119C,NVSL119C Product Specifications

     Specific feature for this series

LED	Embossed Carrier Tape
<p style="text-align: center;">Cathode Mark</p> <div style="border: 1px dashed red; padding: 5px; width: fit-content; margin: 10px auto;"> <p style="text-align: center;">3.2</p> <p style="text-align: center;">Cathode      Anode</p> </div> <p style="text-align: center;">Weight : <span style="border: 1px dashed red; padding: 2px;">typ. 0.031g</span></p> <p style="text-align: center;">[Unit : mm,Tolerance : ±0.2mm]</p>	<p style="text-align: center;">Cathode Mark</p> <div style="border: 1px dashed red; padding: 5px; width: fit-content; margin: 10px auto;"> <p style="text-align: center;">Reel Size: 3,500 LEDs</p> </div> <p style="text-align: center;">[Unit : mm]</p>

This document contains tentative information, Nichia may change the contents without notice.

# 1. LED Outline Dimensions(2 Terminals)/Tape Dimensions

Table 2. NVSW119D,NVSW119F Product Specifications

     Specific feature for this series

LED	Embossed Carrier Tape
<p>光学的中心位置 Location of the optical center</p> <p>3.5</p> <p>0.72</p> <p>0.4</p> <p>Cathode Mark</p> <p>3.1</p> <p>3.5</p> <p>2.3</p> <p>3.2</p> <p>0.5</p> <p>Cathode</p> <p>Anode</p> <p>Weight : <span style="border: 1px dashed red; padding: 2px;">typ. 0.034g</span></p> <p>[Unit : mm,Tolerance : ±0.2mm]</p>	<p><math>\Phi 1.5^{+0.1}</math></p> <p>8<sup>+0.1</sup></p> <p>2<sup>+0.05</sup></p> <p>4<sup>+0.1</sup></p> <p>1.75<sup>+0.1</sup></p> <p>Cathode Mark</p> <p>5.5<sup>+0.05</sup></p> <p>12<sup>+0.1</sup></p> <p>(0.08 クロスバー凹部) (0.08 Crossbar Recess)</p> <p><math>\Phi 1.5^{+0.2}</math></p> <p>0.35<sup>+0.05</sup></p> <p>3.7<sup>+0.1</sup></p> <p>2.55<sup>+0.1</sup></p> <p>3.7<sup>+0.1</sup></p> <p><span style="border: 1px dashed red; padding: 2px;">Reel Size: 3,000 LEDs</span></p> <p>[Unit : mm]</p>

This document contains tentative information, Nichia may change the contents without notice.

# 1. LED Outline Dimensions(3 Terminals)/Tape Dimensions

Table 3. NVSW219C,NVSL219C Product Specifications

     Specific feature for this series

LED	Embossed Carrier Tape
<p style="text-align: center;">Cathode Mark</p> <p style="text-align: center;">Cathode      Anode</p> <p style="text-align: center;">ダイヒートシンク Die Heat Sink</p> <p style="text-align: center;">Weight : <span style="border: 1px dashed red; padding: 2px;">typ. 0.031g</span></p> <p style="text-align: center;">〔Unit : mm,Tolerance : ±0.2mm〕</p>	<p style="text-align: center;">Cathode Mark</p> <p style="text-align: center;">Reel Size: <span style="border: 1px dashed red; padding: 2px;">3,500 LEDs</span></p> <p style="text-align: center;">〔Unit : mm〕</p>

This document contains tentative information, Nichia may change the contents without notice.

# 1. LED Outline Dimensions(3 Terminals)/Tape Dimensions

Table 4. NVSW219D,NVSW219F Product Specifications

     Specific feature for this series

LED	Embossed Carrier Tape
<p>光学的中心位置 Location of the optical center</p> <p>3.5</p> <p>Cathode Mark</p> <p>3.1</p> <p>3.5</p> <p>2.3</p> <p>3.2</p> <p>1.3</p> <p>0.5</p> <p>0.45</p> <p>2.4</p> <p>3.2</p> <p>Cathode</p> <p>Anode</p> <p>ダイヒートシンク Die Heat Sink</p> <p>Weight : <span style="border: 1px dashed red; padding: 2px;">typ. 0.034g</span></p> <p>[Unit : mm,Tolerance : ±0.2mm]</p>	<p>Φ1.5<sup>+0.1</sup></p> <p>8<sup>+0.1</sup></p> <p>2<sup>+0.05</sup></p> <p>4<sup>+0.1</sup></p> <p>1.75<sup>+0.1</sup></p> <p>Cathode Mark</p> <p>5.5<sup>+0.05</sup></p> <p>12<sup>+0.1</sup></p> <p>Φ1.5<sup>+0.2</sup><sub>-0</sub></p> <p>(0.08 クロスバー凹部) (0.08 Crossbar Recess)</p> <p>0.35<sup>+0.05</sup></p> <p>3.7<sup>+0.1</sup></p> <p>2.55<sup>+0.1</sup></p> <p>3.7<sup>+0.1</sup></p> <p><span style="border: 1px dashed red; padding: 2px;">Reel Size: 3,000 LEDs</span></p> <p>[Unit : mm]</p>

This document contains tentative information, Nichia may change the contents without notice.

## 2. Handling Precautions

### 2.1 Handling with bare hands

Do not handle the LEDs with bare hands:

- this may contaminate the LED surface and have an effect on the optical characteristics,
- this may cause the LED to deform and/or the wire to break causing a catastrophic failure (i.e. the LED not to illuminate),
- the lead frame may cause injuries when the LED is handled with bare hands.

### 2.2 Handling with tweezers

Ensure that when handling the LEDs with tweezers, excessive force is not applied to the LED. Otherwise, it may cause damage to the resin (e.g. cut, scratch, chip, crack, delamination and deformation) and the wire to break causing a catastrophic failure (i.e. the LED not to illuminate).

### 2.3 ESD Precautions

The LEDs are sensitive to transient excessive voltages (e.g. ESD, lightning surge). If this excessive voltage occurs in the circuit, it may cause the LED to be damaged causing issues (e.g. the LED to become dimmer or not to illuminate [i.e. catastrophic failure]). When handling the LEDs, ensure that necessary measures have been taken to protect them from transient excess voltages. Refer to the applicable specification for more details.

### 2.4 Stacking assembled PCBs together

Do not stack assembled PCBs together. Otherwise, it may cause damage to the resin (e.g. cut, scratch, chip, crack, delamination and deformation) and the wire to break causing a catastrophic failure (i.e. the LED not to illuminate).

### 2.5 Baking

The storage/packaging requirements for the Nichia 119/219 series LEDs are comparable to JEDEC Moisture Sensitivity Level (MSL) 3 or equivalent. Nichia used IPC/JEDEC STD-020 as a reference to rate the MSL of this LED. If the "After Opening" storage time has been exceeded or any pink silica gel beads are found, ensure that the LED are baked before use. Baking should only be done once.

Table 5. Storage/Baking Conditions

Conditions		Temperature	Humidity	Time
Storage	Before Opening Aluminum Bag	≤ 30° C	≤ 90%RH	Within 1 Year from Delivery Date
	After Opening Aluminum Bag	≤ 30° C	≤ 70%RH	≤ 168 hours
Baking		65±5° C	-	≥ 24 hours

✓ Correct

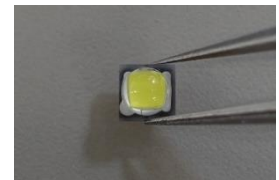

Suggestion: Grab/hold the LEDs with tweezers by the sides of the substrate.

✗ Incorrect

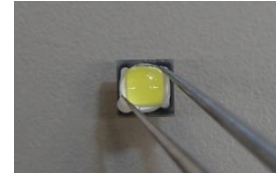

✗ Incorrect

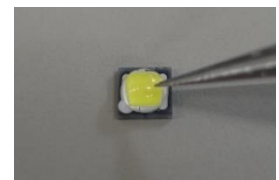

Caution: Do not let the tweezers touch the lens (Silicone Resin).

Figure 1. Examples of proper/improper handling with tweezers

This document contains tentative information, Nichia may change the contents without notice.

### 3. Design Recommendations for Optimal Amount of Solder(2 Terminals※1) Soldering Pad Pattern/Metal Solder Stencil Aperture

※1 Part No.  
NVSW119C,NVSL119C  
NVSW119D,NVSW119F

Table 6. Recommended Soldering Pad Pattern/Metal Solder Stencil Aperture

	Recommended Soldering Pad Pattern	Recommended Metal Solder Stencil Aperture
Solder Pad Pattern and Stencil Aperture as recommended in the specification	<p>Cathode Anode [Unit: mm]</p>	-
Modified Solder Pad Pattern and Stencil Aperture	<p>Cathode Anode [Unit: mm]</p>	<p>[Unit: mm]</p>

--- LED Outline and Electrodes  
 ■ Soldering Pad Pattern  
 ■ Solder Stencil Aperture

Table 7. Recommended Solder /Metal Solder Stencil Conditions

Item	Recommended Conditions
Stencil Thickness	120 [μm]
Solder Paste	Sn-3.0Ag-0.5Cu

☞ The Modified Solder Pad Pattern and Stencil Aperture should be used to control LED tilting and solder balling.

This document contains tentative information, Nichia may change the contents without notice.

### 3. Design Recommendations for Optimal Amount of Solder(3 Terminals)<sup>※2</sup> Soldering Pad Pattern/Metal Solder Stencil Aperture

※2 Part No.  
NVSW219C, NVSL219C  
NVSW219D, NVSW219F

Table 8. Recommended Soldering Pad Pattern/Metal Solder Stencil Aperture

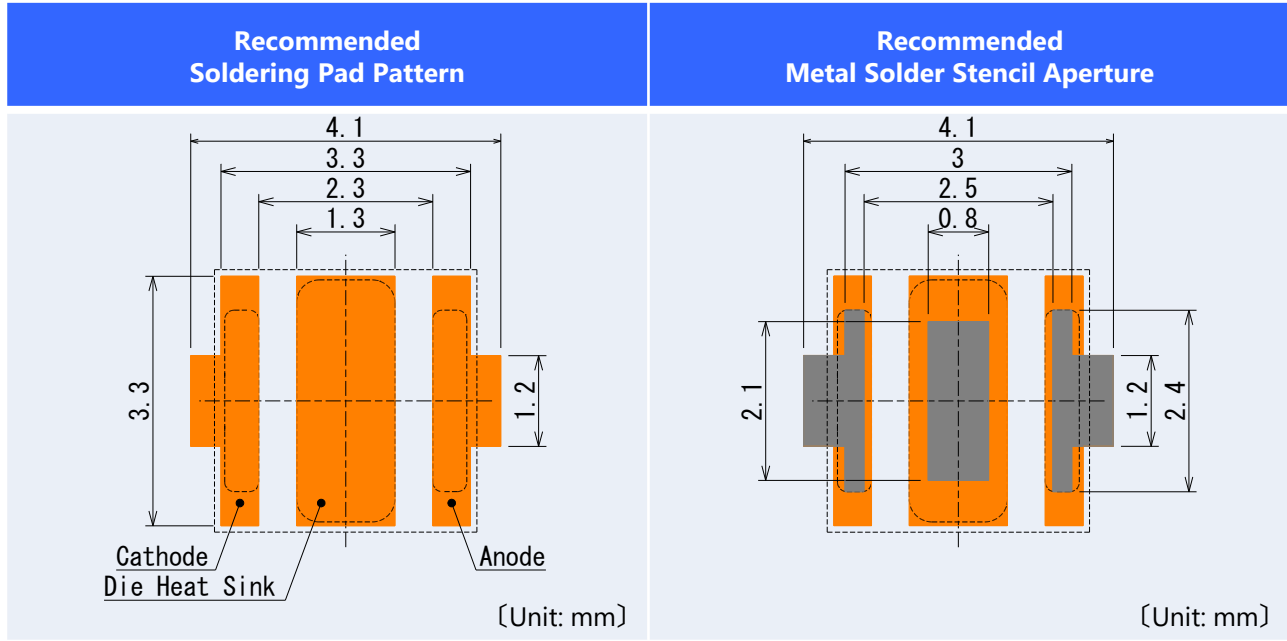

--- LED Outline and Electrodes  
 ■ Soldering Pad Pattern  
 ■ Solder Stencil Aperture

Table 9. Recommended Solder /Metal Solder Stencil Conditions

Item	Recommended Conditions
Stencil Thickness	120 [μm]
Solder Paste	Sn-3.0Ag-0.5Cu

This document contains tentative information, Nichia may change the contents without notice.



## 4. Precautions for Setting Up a Pick-and-Place Machine/Nozzle

Table 10. Cautions/Suggestions for Setting Up Equipment

Item	Recommended Conditions/Specifications	Cautions/Suggestions
Pick-and-Place machine	Modular mounter	See the note below this table.
Pick-and-Place Nozzle	Specially designed nozzle (see Figure 2)	See "Pick-and-Place Nozzle" on Page 10 for the details.
Tape-and-reel feeder	Electrical (motorized) feeder Tape width: 12mm Feed length: 8mm	See "Tape-and-Reel Feeder" on Page 11 for the details.
Nozzle height for pick-up operations	The contact surface of the nozzle head for pick operations should be adjusted to the top surface of the embossed carrier tape pocket.	See "Recommended Nozzle Height for Pick-up Operations" on Page 11 for the details.
Nozzle height for placement operations (i.e. placement depth)	0.2mm for placement depth	See "Recommended Nozzle Height for Placement Operations (Placement Depth)" on Page 12 for the details.
Imaging-based Automatic Inspection	Using the electrode as a reference is recommended to locate the center of the LED.	See "Imaging-based Automatic Inspection" on Page 12 for the details.

Note:

- The recommended conditions/specifications above have been determined under the following verification conditions:  
 Pick-and-Place machine (modular mounter):
  - YS100 High-Speed General-Purpose Modular (manufactured by Yamaha Motor Co., Ltd.)

## 4.1 Pick-and-Place Nozzle

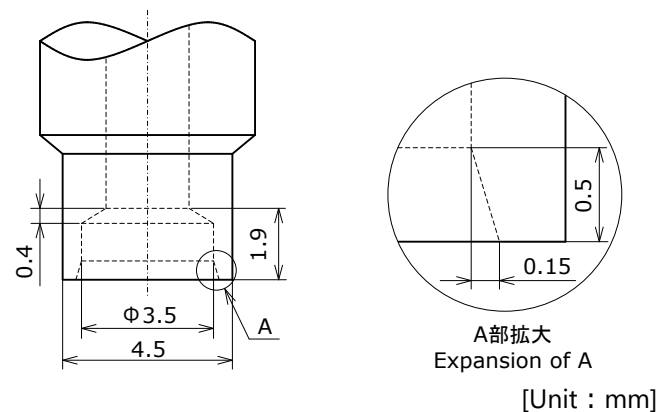

Figure 2. Recommended Nozzle Dimensions

## 4.2 Part Height

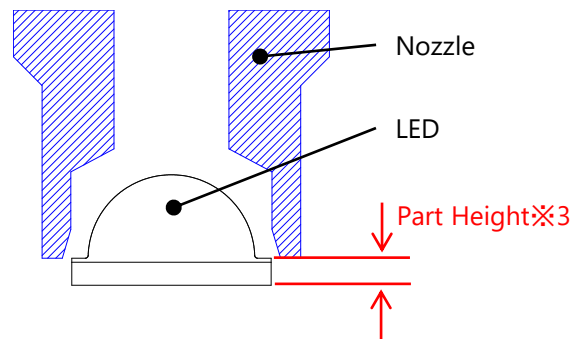

Figure 3. Cross-sectional view of a nozzle when transporting an Nichia 119/219 series LEDs

※3 Note: The height of the part varies depending on which LEDs are being used (refer to Table 11) for further details.

1. When selecting/designing the pick-and-place nozzle, it is important to make sure that there is absolutely no contact between the nozzle and the lens. Ensure proper clearance by taking into consideration the dimensional tolerance of the nozzle and the dimensional tolerance of the LED lens. Nichia's 119/219 series can be used with the pick-and-place nozzle shown in Figure 2.
2. As shown in Figure 2, the nozzle tip should only touch the flat corners of the LED's top surface to hold the LEDs. Ensure that it does not come in contact with the lens. The LEDs uses a silicone resin for the lens and internal pre-coating resin; the silicone resin is soft. If pressure is applied to the lens, it may cause the lens to be damaged, chipped and/or delaminated. If the lens is damaged, chipped, delaminated and/or deformed, it may cause the internal connection to fail causing a catastrophic failure (i.e. the LED not to illuminate) and/or reliability issues (e.g. the LED to corrode and/or to become dimmer, the color/directivity to change, etc.) Ensure that no amount of pressure is applied to the lens.

Table 11. Part Height

   Part Height

NVSW119C, NVSL119C NVSW219C, NVSL219C	NVSW119D, NVSW219D NVSW119F, NVSW219F

[Unit : mm]

4.3 Tape-and-Reel Feeder **Top Cover Tape Removal Position**

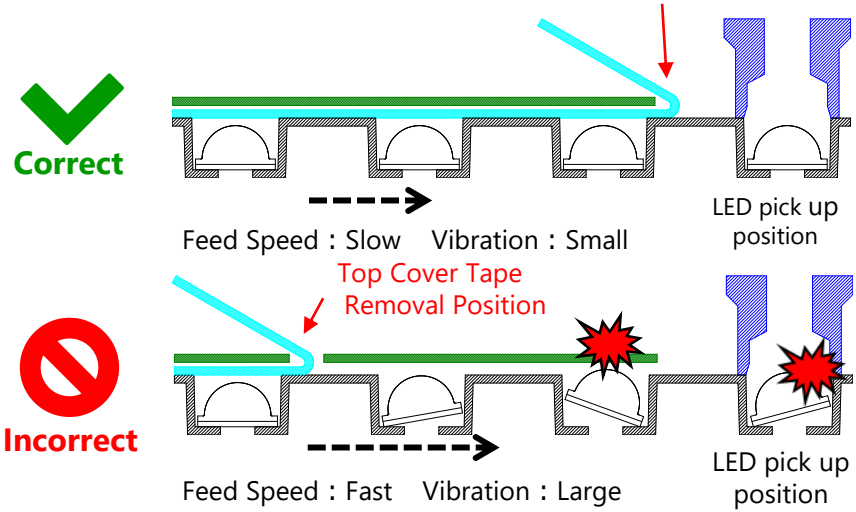

Figure 4. Examples of Correct/Incorrect Top Cover Tape Removal Positions

4.4 Recommended Nozzle Height for Pick-up Operations

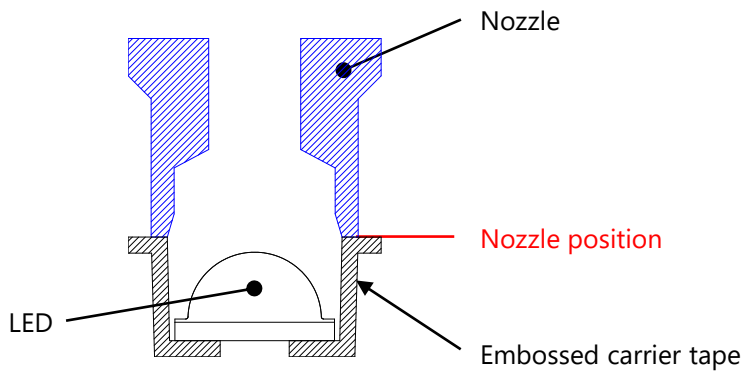

Figure 5. Cross-sectional view of a nozzle when transporting a LED to a PCB

1. Recommended setting for the tape-and-reel feeder.
  - Tape width: 12mm
  - Feed length: 8mm
2. Use a tape-and-reel feeder that ensures it does not create excessive vibrations causing assembly issues.
  - Example: Electrical (motorized) feeder
3. When removing the top cover tape it should be done adjacent to the target LED (See Figure 4). Otherwise, it may shake the embossed carrier tape and cause the LED to move within the tape pocket. This may cause
  - the nozzle to fail to pick up the LED or not to pick it up properly and shift while on the nozzle during the transport to the PCB (i.e. pick-up/placement failure)
  - the LED to hit the feeder cover and become damaged.
1. Ensure that the nozzle only goes down to the top edge of the tape pocket and does not directly come into contact with the LED.
 

Note: The reference level for the nozzle setting is at the top edge of the tape pocket.
2. The recommended nozzle height for pick-up operations has been determined by Nichia under the verification conditions (See Table 10) and may not function as expected with some other pick-and-place machines. If the pick-up operations are unstable even with using the recommended nozzle height, adjust the nozzle height appropriate for the pick-and-place machine being used.
  - If the pick point of the nozzle is too high,
    - it may cause insufficient suction power leading to picking errors (e.g. the nozzle's failure to pick/lift the LED into the air, incorrect picking causing the LED to tilt when in the air).
  - If the pick point of the nozzle is too low,
    - it may cause issues (e.g. causing the embossed carrier tape to shake, causing the tape pocket to deform) leading to picking failure and/or damage to the LED.

### 4.5 Recommended Nozzle Height for Placement Operations (Placement Depth)

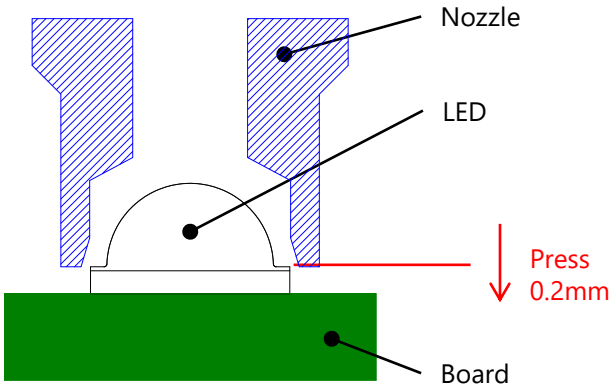

Figure 6. Recommended Nozzle Height for Placement (Placement Depth)

1. After the LED is mounted onto solder paste on the PCB, the nozzle should further press the LED 0.2mm into the PCB.  
If the release point of the nozzle is too high,  
- it may cause placement issues (e.g. the LED to stick to the nozzle after placement, the LED to become soldered to the PCB in a tilted position, etc.).  
If the release point of the nozzle is too low,  
- excessive forces may be applied to the LED during placement and it may cause the LED to become damaged.
2. The height of the part varies depending on which LEDs are being used. Customers must check the Nichia specifications before mounting the LEDs.

### 4.6 Imaging-based Automatic Inspection

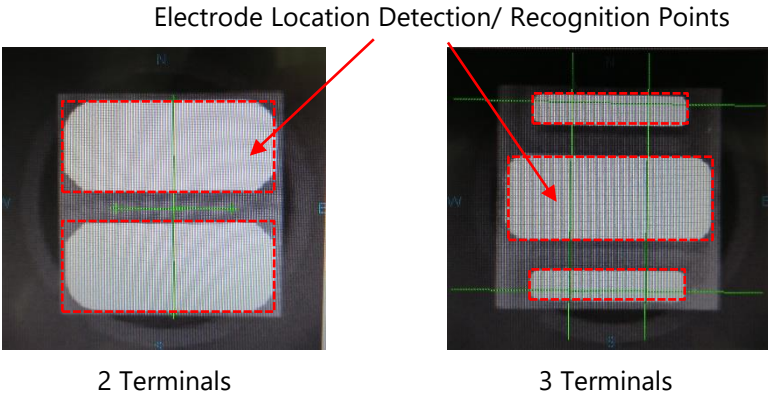

Figure 7. Recommended reference points to detect, recognize, or locate the electrodes

1. Nichia recommends using the electrodes as a reference to locate the center of the LED.
2. If the imaging device has trouble detecting/recognizing the electrodes due to the uniqueness of the electrode pattern, adjust it to detect/recognize the outer portions of the electrodes (i.e. the areas circled in red in Figure 7 to the left).

### 5. Precautions When Reflow Soldering

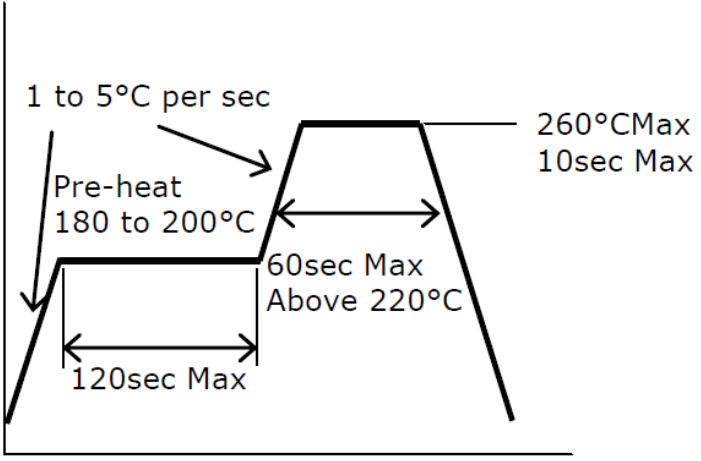

Figure 8. Recommended Reflow Soldering Condition (Lead-free Solder)

1. Reflow soldering must not be performed more than twice.
2. Using the recommended reflow soldering conditions (See Figure 8 to the left) as a reference, modify if necessary, the recommended reflow conditions specified by the manufacturer of the solder paste being used.  
Note: To ensure that these reflow conditions have no negative effect on the LEDs, perform sufficient verification prior to use.
3. When cooling the LEDs from the peak temperature a gradual cooling slope is recommended; do not cool the LEDs rapidly.
4. During reflow soldering, the heat and atmosphere in the reflow oven may cause the optical characteristics to degrade. In particular, reflow soldering performed with an air atmosphere may have a greater negative effect on the optical characteristics than if a nitrogen atmosphere is used; Nichia recommends using a nitrogen reflow atmosphere.

## Disclaimer

This application note is a controlled document of Nichia Corporation (Nichia) published to provide technical information/data for reference purposes only. By using this application note, the user agrees to the following:

- This application note has been prepared solely for reference on the subject matters incorporated within it and Nichia makes no guarantee that customers will see the same results for their chosen application.
- The information/data contained herein are only typical examples of performances and/or applications for the product. Nichia does not provide any guarantees or grant any license under or immunity from any intellectual property rights or other rights held by Nichia or third parties.
- Nichia makes no representation or warranty, express or implied, as to the accuracy, completeness or usefulness of any information contained herein. In addition, Nichia shall not be liable for any damages or losses arising out of exploiting, using, or downloading or otherwise this document, or any other acts associated with this document.
- The content of this application note may be changed without any prior or subsequent notice.
- Copyrights and all other rights regarding the content of this document are reserved by Nichia or the right holders who have permitted Nichia to use the content. Without prior written consent of Nichia, republication, reproduction, and/or redistribution of the content of this document in any form or by any means, whether in whole or in part, including modifications or derivative works hereof, is strictly prohibited.

**NICHIA CORPORATION** 491 Oka, Kaminaka-Cho, Anan-Shi,  
TOKUSHIMA 774-8601, JAPAN  
<http://www.nichia.co.jp> Phone: +81-884-22-2311 Fax: +81-884-21-0148

This document contains tentative information, Nichia may change the contents without notice.