

**NICHIA CORPORATION**

**SPECIFICATIONS FOR NICHIA WIDE ANGLE  
LIGHT CLUSTER**

**PART NO. NALW008AL/NALW008AL-H6**

- RoHS Compliant



- This product is only for general illumination use. However, this product must not be used for obstruction, emergency, medical, display, and machine vision applications, since these applications are not considered to be general illumination.

## Table of Contents

1. FEATURES
2. KEY PRODUCT DETAILS
3. ABSOLUTE MAXIMUM RATINGS
4. RATED OPERATING CONDITION
5. INITIAL ELECTRICAL/OPTICAL CHARACTERISTICS
6. RANKS
7. CHROMATICITY DIAGRAM
8. OUTLINE DIMENSIONS AND CIRCUIT DIAGRAM
9. CONNECTORS
10. RELIABILITY
  - (1) Tests and Results
  - (2) Failure Criteria
11. FINISHED PRODUCT INSPECTIONS
  - (1) Inspection/Test Items
  - (2) Failure Criteria
12. PACKAGING
13. LOT/RANK INFORMATION
  - (1) Lot Information Code
  - (2) Rank Information Code
14. PRECAUTIONS
  - (1) Storage
  - (2) Directions for Use
  - (3) Handling Precautions
  - (4) Design Consideration
  - (5) Thermal Management
  - (6) Electrostatic Discharges (ESD) and Electrical Surges
  - (7) Cleaning
  - (8) Eye Safety
  - (9) Safety Precautions
  - (10) Electromagnetic Interference (EMI) Precautions
  - (11) Packaging Materials for Transport
  - (12) Environmental Information
  - (13) Miscellaneous

## 1. FEATURES

This product has 288 LED chips with respective lenses. "Product" and "Products" as used herein refer to the product(s). "LED" and "LEDs" as used herein refer to the LED chip(s) and the lens(es) collectively. "LED chip" and "LED chips" as used herein refer to the LED chip(s).

- This product has a wide viewing angle due to the lens developed with Nichia's original technology.
- With this product, it is possible to design luminaires that are thin, have a uniform luminance, low glare, and a lighter weight.

## 2. KEY PRODUCT DETAILS

Item	Description
Outline Dimensions	216 × 433 × (3)mm
PCB	CEM3
Number of LED Chips	288 chips (16 series × 18 parallel)
Weight	Approx. 220g

\* The dimension in parentheses is for reference purposes only.

## 3. ABSOLUTE MAXIMUM RATINGS

Item	Symbol	Absolute Maximum Rating	Unit
Forward Current	$I_F$	1710	mA
Power Dissipation	$P_D$	79.2	W
Operating Temperature	$T_{opr}$	-20~60	°C
Storage Temperature	$T_{stg}$	-20~85	°C
Junction Temperature *	$T_J$	110	°C

\* Regarding how to calculate the  $T_J$ , refer to the Thermal Management section.

## 4. RATED OPERATING CONDITION

Item	Symbol	Rated Value	Unit
Forward Current	$I_F$	426	mA

## 5. INITIAL ELECTRICAL/OPTICAL CHARACTERISTICS

- The table below shows the characteristics for the R8000 products.

Item	Symbol	Condition	Typ.		Unit
			Rank sm503	Rank sm273	
Forward Voltage	$V_F$	$I_F=426mA$	43.5		V
Luminous Flux	$\Phi_v$	$I_F=426mA$	3010	2750	lm
CRI	$R_a$	$I_F=426mA$	83		—
	$R_9$		10		—
Chromaticity Coordinate	x	$I_F=426mA$	0.3447	0.4578	—
	y		0.3553	0.4101	—

- The table below shows the characteristics for the R9050j85 products.

Item	Symbol	Condition	Typ.		Unit
			Rank sm503	Rank sm273	
Forward Voltage	$V_F$	$I_F=426mA$	43.5		V
Luminous Flux	$\Phi_v$	$I_F=426mA$	2950	2710	lm
CRI	$R_a$	$I_F=426mA$	93		—
	$R_9$		65		—
	$R_{15}$		93		—
Chromaticity Coordinate	x	$I_F=426mA$	0.3447	0.4578	—
	y		0.3553	0.4101	—

\* Characteristics at  $T_j=25^\circ C$  and measured in pulse mode.

\* Optical Characteristics as per CIE 127:2007 standard.

\* Chromaticity coordinates as per CIE 1931 Chromaticity Chart.

\* The R9050j85 products use a unique red phosphor that has a slow response time; when compared with the blue chip and green phosphor in the product, the red will fluoresce with a delayed pulse of about 10msec and have an afterglow for about 10msec after the blue chip dims.

## 6. RANKS

- The table below shows the characteristics for the sm503/R8000 products.

Item	Rank	Condition	Min.	Max.	Unit
Forward Voltage	—	$I_F=426\text{mA}$	41.5	45.4	V
Luminous Flux	—	$I_F=426\text{mA}$	2710	3310	lm
CRI	R8000	$R_a$	80	—	—
		$R_9$	>0		

- The table below shows the characteristics for the sm273/R8000 products.

Item	Rank	Condition	Min.	Max.	Unit
Forward Voltage	—	$I_F=426\text{mA}$	41.5	45.4	V
Luminous Flux	—	$I_F=426\text{mA}$	2480	3020	lm
CRI	R8000	$R_a$	80	—	—
		$R_9$	>0		

- The table below shows the characteristics for the sm503/R9050j85 products.

Item	Rank	Condition	Min.	Max.	Unit
Forward Voltage	—	$I_F=426\text{mA}$	41.5	45.4	V
Luminous Flux	—	$I_F=426\text{mA}$	2660	3240	lm
CRI	R9050j85	$R_a$	90	—	—
		$R_9$	50		
		$R_{15}$	85		

- The table below shows the characteristics for the sm273/R9050j85 products.

Item	Rank	Condition	Min.	Max.	Unit
Forward Voltage	—	$I_F=426\text{mA}$	41.5	45.4	V
Luminous Flux	—	$I_F=426\text{mA}$	2440	2980	lm
CRI	R9050j85	$R_a$	90	—	—
		$R_9$	50		
		$R_{15}$	85		

Color Ranks measured at  $I_F=426\text{mA}$ .

The color ranks have chromaticity ranges within a 3-step MacAdam ellipse.

		Rank	
		sm503	sm273
Color Temperature (Unit: K)	$T_{CP}$	5000	2700
Center Point	x	0.3447	0.4578
	y	0.3553	0.4101
Minor Axis	a	0.003555	0.004056
Major Axis	b	0.008418	0.007872
Ellipse Rotation Angle	$\Phi$	-31.78	-36.05

\* Characteristics at  $T_J=25^\circ\text{C}$  and measured in pulse mode.

\* Forward Voltage Tolerance:  $\pm 0.46\text{V}$

\* Luminous Flux Tolerance:  $\pm 6\%$

\* Color Rendering Index  $R_a/R_{15}$  Tolerance:  $\pm 2$

\* Color Rendering Index  $R_9$  Tolerance:  $\pm 7$

\* Chromaticity Coordinate Tolerance:  $\pm 0.005$

\* Each rank has two sub-bins: Sub-bin I and Sub-bin II.

\* See Chromaticity Diagram below for the details of the ranks.

Definition of the MacAdam ellipse ranks

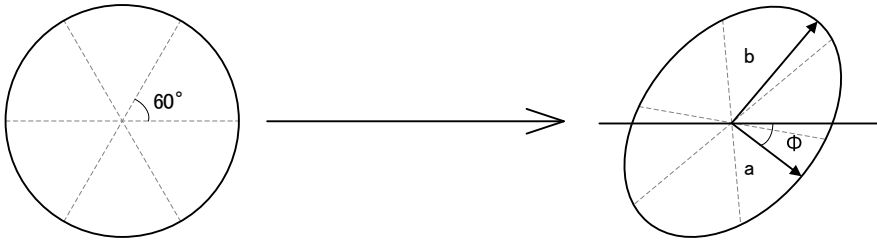

A perfect circle is divided into 60 degree-sections and then transformed into the MacAdam ellipse that is presented on the chromaticity diagram in this specification.

7. CHROMATICITY DIAGRAM

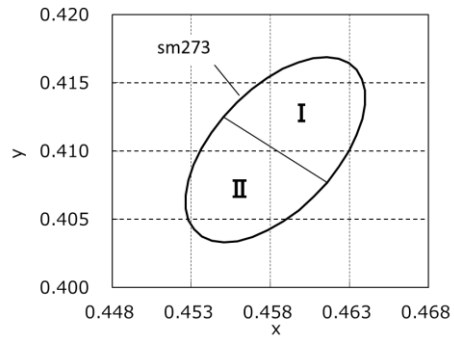
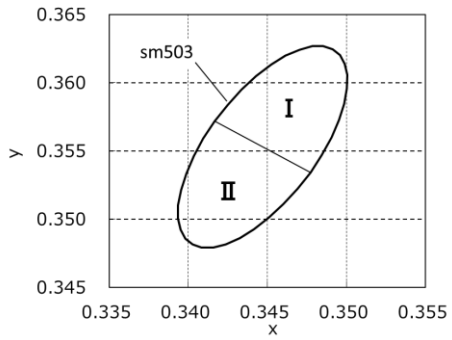



## 9. CONNECTORS

Connectors (CN1 and CN2): Part number of ES5S001JFAR5500 manufactured by Japan Aviation Electronics Industry, Ltd.

Absolute Maximum Rating Current for the Sockets: 4.0A (When AWG 24-26 wires are used.)

Suitable Wire Size: AWG 24-26

Connector No.	Polarity
CN1	+(Vin)
CN2	-(GND)

\* The connector number and the polarity symbol are provided on the PCB by removing the solder resist.

## 10. RELIABILITY

### (1) Tests and Results

Test	Reference Standard	Test Conditions	Test Duration	Failure Criteria #	Units Failed/Tested
High Temperature Storage*	JEITA ED-4701 200 201	T <sub>A</sub> =100°C	1000hours	#1	0/3
Temperature Humidity Storage*	JEITA ED-4701 100 103	T <sub>A</sub> =60°C, RH=90%	1000hours	#1	0/3
Low Temperature Storage*	JEITA ED-4701 200 202	T <sub>A</sub> =-40°C	1000hours	#1	0/3
Temperature Cycle*	IEC(JIS)-60068-2-14	25°C~60°C~-20°C 5 hours/cycle	200 cycles	#1	0/3
Room Temperature Operating Life*		T <sub>A</sub> =25°C, I <sub>F</sub> =426mA	1000hours	#1	0/3
High Temperature Operating Life*		T <sub>A</sub> =60°C, I <sub>F</sub> =426mA	1000hours	#1	0/3
Temperature Humidity Operating Life*		T <sub>A</sub> =60°C, RH=90%, I <sub>F</sub> =426mA	500hours	#1	0/3
Low Temperature Operating Life*		T <sub>A</sub> =-40°C, I <sub>F</sub> =426mA	1000hours	#1	0/3
Drop Test	JIS Z0200 Z0202	Height: 40cm Directions: 6 faces, 3 edges, 1 corner, 1 time per direction	-	#2	0/1
Package Vibration	JIS Z0200 Z0232	Acceleration rate: ±7.35m/s <sup>2</sup> Frequency: 5~100Hz Sweep rate: 0.5 oct./min. 1 hour per direction (parallel and perpendicular)	-	#2	0/1

\* The tests were performed on a similar product (the NALW009AL).

### (2) Failure Criteria

Criteria #	Item	Conditions	Failure Criteria
#1	Forward Voltage (V <sub>F</sub> )	I <sub>F</sub> =426mA	>U.S.L.×1.1
	Luminous Flux (Φ <sub>i</sub> )	I <sub>F</sub> =426mA	<L.S.L.×0.7
#2	Emission	I <sub>F</sub> =426mA	Emission failure or abnormal emission of the product
	Packaging Material	-	Impacts on the product

\* U.S.L.: Upper Specification Limit, L.S.L.: Lower Specification Limit

\* Measurements are performed after allowing the products to return to room temperature.



## 11. FINISHED PRODUCT INSPECTIONS

### (1) Inspection/Test Items

Inspection	Item	Conditions	Sample Size	Failure Criteria
In-process Inspection	Appearance	—	Full inspection	See (2) Failure Criteria below.
	Emission	$I_F=426\text{mA}$		
	Optical Characteristics	$I_F=426\text{mA}$		See the customer specific specification
	Electrical Characteristics	$I_F=426\text{mA}$		
QC Inspection	Appearance	—	AQL inspection level S-1 as per MIL-STD-105	See (2) Failure Criteria below.
	Emission	$I_F=426\text{mA}$		
	Optical Characteristics	$I_F=426\text{mA}$		See the customer specific specification
	Electrical Characteristics	$I_F=426\text{mA}$		

### (2) Failure Criteria

Item	Failure Criteria
Appearance	<ul style="list-style-type: none"> <li>• Products that have typographical issues (e.g. misspelled, omitted and/or unreadable words) with the product code indicated on the product and/or the lot information indicated on the labels attached to the packages (i.e. anti-static bag, cardboard box) are unacceptable.</li> <li>• Products that have damage (e.g. cuts, scratches, chips, cracks, delamination, and/or deformation), contamination (e.g. spots, stains, marks, etc.), and/or any missing components causing the product to not perform as detailed in the Initial Electrical/Optical Characteristics section are unacceptable.</li> <li>• Products that are not within the outline dimensions, including the tolerances, are unacceptable.</li> </ul>
Emission	<ul style="list-style-type: none"> <li>• Products that do not illuminate properly (i.e. failing to perform as detailed in the Initial Electrical/Optical Characteristics section) are unacceptable.</li> <li>• Products that do not illuminate are unacceptable.</li> <li>• Products whose emitted light looks abnormal (e.g. light distribution, color, etc.) are unacceptable.</li> </ul>

12. PACKAGING

Part No. NALWxxxxxx  
 No. STHZ-A33953A  
 (単位Unit: mm)

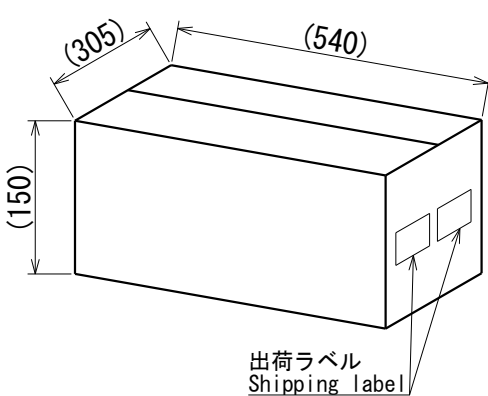
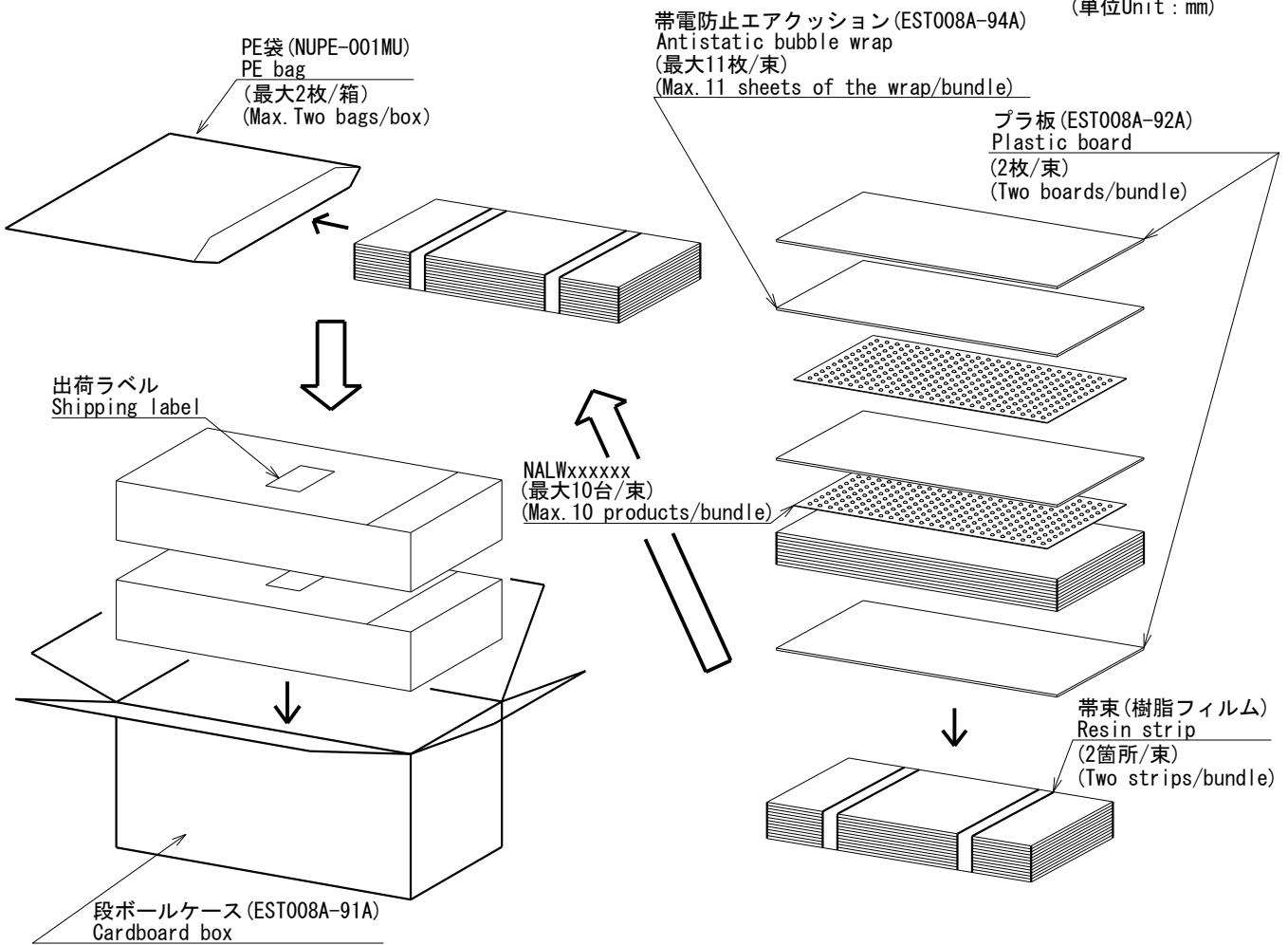

出荷ラベル  
 Shipping label



最大20台  
 Number of products per box: 20 products (max.)

約6.0kg  
 Weight of the shipment: Approx. 6.0kg (max.)

- PE bag=Polyethylene bag
- 段ボールケースサイズ及び梱包数量は、図の通りとします。  
 The external dimensions for the cardboard box and the maximum number of the products for the box are as specified above.
- 出荷ラベルはPE袋と段ボールに添付し、共通のものとなります。  
 The same shipping labels are attached to the PE bag(s) and the cardboard box.
- 客先型名を\*\*\*\*\*で示します。  
 日垂型番、客先型名対応表を参照してください。  
 客先型名が設定されていない場合は空白です。  
 \*\*\*\*\* shows the Customer P/N; see the Nichia P/N and Customer P/N section. The customer P/N will only be included when specifically requested.
- LOT表記方法についてはLOT表記の項を参照してください。  
 For the details of the lot information code, see the Lot Information Code section.
- RANK表記方法についてはRANK表記の項を参照してください。  
 For the details of the rank information code, see the Rank Information Code section.
- 右側のQRコードは弊社工程管理用です。  
 The 2D code printed on the shipping labels is for Nichia's internal use only.
- ラベル図は実際のラベル通りの文字や各種コードの配置を表しています。  
 The figure of the label is an example of an actual shipping label.

### 13. LOT/RANK INFORMATION

#### (1) Lot Information Code

The lot information is provided on the product and the shipping labels using the following alphanumeric code. For the laser marking/label positions, see Page 6 and page 9.

OO☆□△

OO: Year of Manufacture

☆: Month of Manufacture

□: Alphanumeric serial number for the month. Consisting of up to 34 different numbers and letters. 0-9 and A-Z except for I and O, are used.

△: Nichia's control number

Year	OO	Month	☆	Month	☆
2022	22	1	1	7	7
2023	23	2	2	8	8
2024	24	3	3	9	9
2025	25	4	4	10	A
2026	26	5	5	11	B
2027	27	6	6	12	C

#### (2) Rank Information Code

The rank information is provided on the shipping labels using the following alphanumeric code. For the label positions, see Page 9.

smxx3-zywv

xx: Color Temperature Rank

z: Sub-bin

y: Luminous Flux Rank

w: Forward Voltage Rank

v: CRI Rank

Color Temperature	xx
5000K	50
2700K	27

Sub-bin	z
I	I
II	II

Rank	y
—	s

Rank	w
—	s

Rank	v
R8000	1
R9050j85	4

## 14. PRECAUTIONS

### (1) Storage

- The parts/materials (e.g. housing, gasket/seal, secondary lens, lens cover, thermal grease, etc.) used with the product in the same assembly/system may release corrosive gases containing sulfur, halogens, etc. A light-up test, sufficient verifications, etc. must be performed at the finished product level (i.e. automotive headlamp, luminaire, etc.) prior to use taking into consideration the conditions/environments in which the finished product will actually be used to ensure that the expected performance for the finished product is maintained. See below for the detailed information.

Issues that may be caused by corrosive gases containing sulfur, halogens, etc.:

The LEDs have plated parts. If the LEDs are exposed to corrosive gases containing sulfur, halogens, etc., it may cause the plated surface to tarnish. If the gases penetrate the LEDs (e.g. emitting surface, package material, etc.), it may cause the surface of the plated parts inside the package to tarnish. In addition, it has been confirmed that if a silicone resin is used in the LEDs, the gases may accelerate degradation of the silicone resin. As a result, the optical characteristics may be adversely affected (i.e. significant reduction in the brightness, significant color shift, etc.); in the worst case, the circuit could become open causing a catastrophic failure (i.e. the LEDs not to illuminate). When determining the storage environment for the product and/or selecting parts/materials that will be used with the product in the finished product, it must be ensured prior to use that the corrosive gases that may be generated will not affect the product.

- To avoid condensation, the product must not be stored in areas where temperature and humidity fluctuate greatly.
- Do not store the product in a dusty environment.
- Do not expose the product to direct sunlight and/or an environment over a long period of time where the temperature is higher than normal room temperature.
- Nichia recommends the products are stored under an environment of  $25\pm 5^{\circ}\text{C}$ ,  $\leq 70\%$  RH.

### (2) Directions for Use

- This product is designed to be operated at a forward current. Ensure that no voltage is applied to the product in the forward/reverse direction while the product is off. If the product is used in an environment where reverse voltages are applied to the product continuously, it may cause electrochemical migration to occur causing the LED chips to be damaged.
- If the product is used for outdoor applications, ensure that necessary measures are taken (e.g. protecting the product from water/salt damage and high humidity).
- Ensure that transient excessive voltages (e.g. lightning surge) are not applied to the LED chips.
- If the product is used in environments where temperature fluctuates greatly, it may cause cracks in the solder joints between the electronic devices used in the product including the LED chips and PCB; ensure that the thermal design of the chosen application is appropriate for the conditions/environments where the product will be used.
- To stabilize the characteristics of the product while in use, Nichia recommends that the product is operated at  $I_F \geq 120\text{mA}$ .

### (3) Handling Precautions

- Handling the product

When handling the product, do not touch the LEDs. This may contaminate the lenses causing the optical characteristics to be affected and/or the lenses/LED chips to be removed from the PCB resulting in a catastrophic failure (i.e. the product not to illuminate).

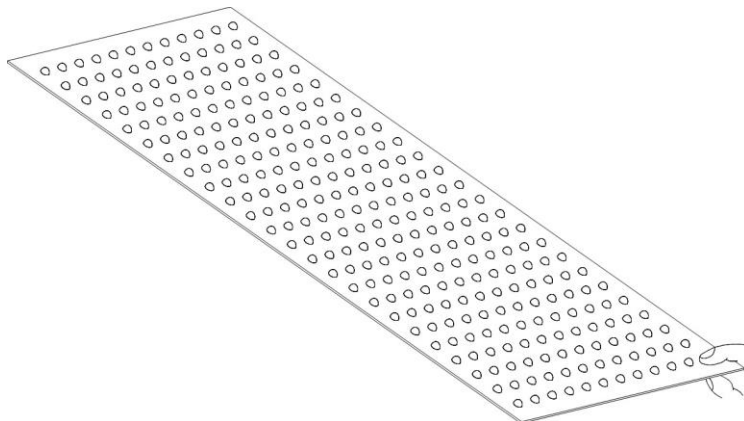

- Dropped products

Do not drop the product. If products that have been dropped are used, ensure that there are no issues (e.g. the lenses/LED chips are removed from the PCB) before use.

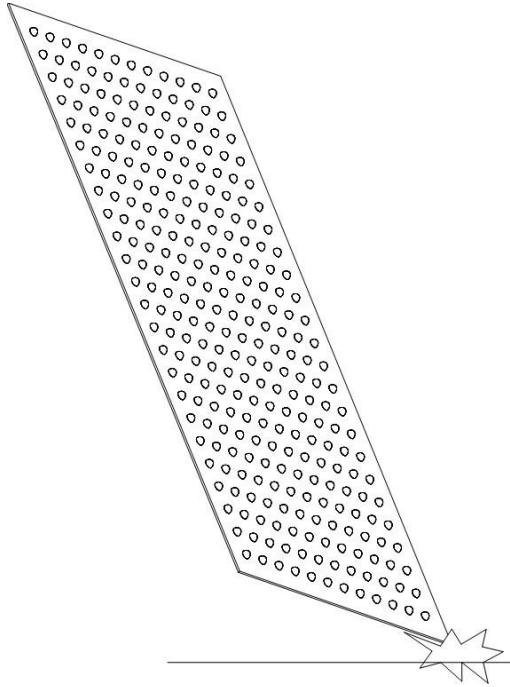

- Stacking the products

This product uses a silicone resin for the lens; the silicone resin is soft. Do not stack the products on top of one another. Otherwise, it may damage the lenses (e.g. cut, scratch, chip, crack, removal) and/or cause the LED chips to be removed from the PCB resulting in a catastrophic failure.

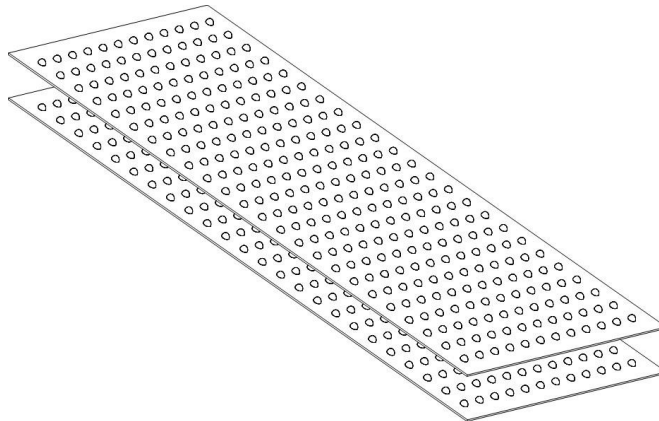

- Bubble wrap

When removing the sheet of bubble wrap that is placed on the top surface of the product, do not pull it across the product horizontally. Otherwise, the lens may stay attached to the bubble wrap while the bubble wrap travels causing damage to the lenses (e.g. cut, scratch, chip, removal) and/or the LED chips to be removed from the PCB resulting in a catastrophic failure. Remove the sheet of bubble wrap by lifting it up vertically.

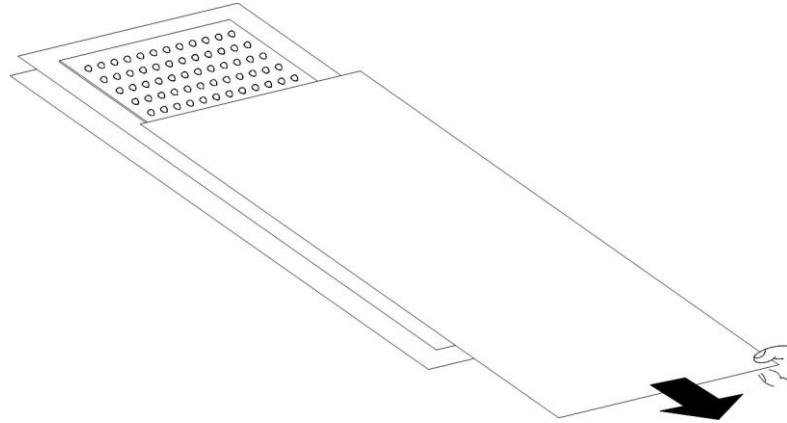

#### (4) Design Consideration

- If two or more products are electrically connected, ensure that those products are operated at a current <math><3.0A</math>.
- The parts/materials (e.g. housing, gasket/seal, secondary lens, lens cover, thermal grease, etc.) used with the product in the same assembly/system may release corrosive gases containing sulfur, halogens, etc., and/or volatile organic compounds (VOCs). A light-up test, sufficient verifications, etc. must be performed at the finished product level (i.e. automotive headlamp, luminaire, etc.) prior to use taking into consideration the conditions/environments in which the finished product will actually be used to ensure that the expected performance for the finished product is maintained. See below for the detailed information.

Issues that may be caused by corrosive gases containing sulfur, halogens, etc.:

The LEDs have plated parts. If the LEDs are exposed to corrosive gases containing sulfur, halogens, etc., it may cause the plated surface to tarnish. If the gases penetrate the LEDs (e.g. emitting surface, package material, etc.), it may cause the surface of the plated parts inside the package to tarnish. In addition, it has been confirmed that if a silicone resin is used in the LEDs, the gases may accelerate degradation of the silicone resin. As a result, the optical characteristics may be adversely affected (i.e. significant reduction in the brightness, significant color shift, etc.); in the worst case, the circuit could become open causing a catastrophic failure (i.e. the LEDs not to illuminate). When determining the storage environment for the product and/or selecting parts/materials that will be used with the product in the finished product, it must be ensured prior to use that the corrosive gases that may be generated will not affect the product.

Issues that may be caused by VOCs:

If VOCs that have been released from the parts/materials and/or organic additives used with the product in the finished product penetrate into the LEDs and remain inside the LEDs, the VOCs can discolor after being exposed to heat and/or photon energy. This may cause the optical characteristics to be adversely affected (i.e. significant reduction in the brightness, significant color shift, etc.). This adverse effect may be improved by ventilating the environment (i.e. the product is not used in a hermetically sealed environment) to prevent the VOCs from remaining inside the LEDs. When selecting parts/materials that will be used with the product in the finished product, it must be ensured prior to use that there are no issues with the substances found in those parts/materials and/or that the expected performance for the finished product is maintained by performing a light-up test, sufficient verifications etc. taking into consideration the conditions/environments in which the finished product will actually be used.

- If an external controlling device (e.g. PWM dimmer) is used for the product, sufficient verification must be performed with the conditions/environments in which the chosen application containing the product will actually be used to ensure that the required performance for the chosen application is achieved.
- The characteristics of the product (e.g. chromaticity, color rendering index, etc.) will vary depending on how the product is designed into the application, under what conditions/environments it is used, and how long it has been used. To ensure that there are no issues (e.g. deviations/changes in the characteristics, etc.) with the chosen application, perform a sufficient verification prior to use.

(5) Thermal Management

- The Absolute Maximum Junction Temperature ( $T_J$ ) must not be exceeded under any circumstances. The increase in the junction temperature of an LED chip of a product while in operation may vary depending on the thermal resistance of the chosen housing and how the products are attached to the housing. Ensure that when using the products for the chosen application, heat is not concentrated in an area and properly managed in the system/assembly.
- The operating current should be determined by considering the temperature conditions surrounding the product (i.e.  $T_A$ ). Ensure that when operating the product, proper measures are taken to dissipate the heat.
- The following equation can be used to calculate the LED chip temperature (i.e.  $T_J$ ) once the saturation temperature at the junction has been reached.

$$T_J = T_b + R_{\theta Jb} \cdot W$$

$T_J$  = LED chip Junction Temperature: °C

$T_A$  = Ambient Temperature: °C

$T_b$  = PCB Surface Temperature (measured at 5.0mm toward the cathode from the center of the LED chip as shown in the picture below): °C

$R_{\theta JA}$  = Thermal Resistance from Junction to Ambient: °C/W

$R_{\theta Jb}$  = Thermal Resistance from Junction to  $T_b$  Measurement Point: °C/W ( $\approx 0.14^\circ\text{C/W}$ )

$W$  = Input Power per LED chip ( $I_F \times V_F$ ): W

$T_b$  Measurement Point:

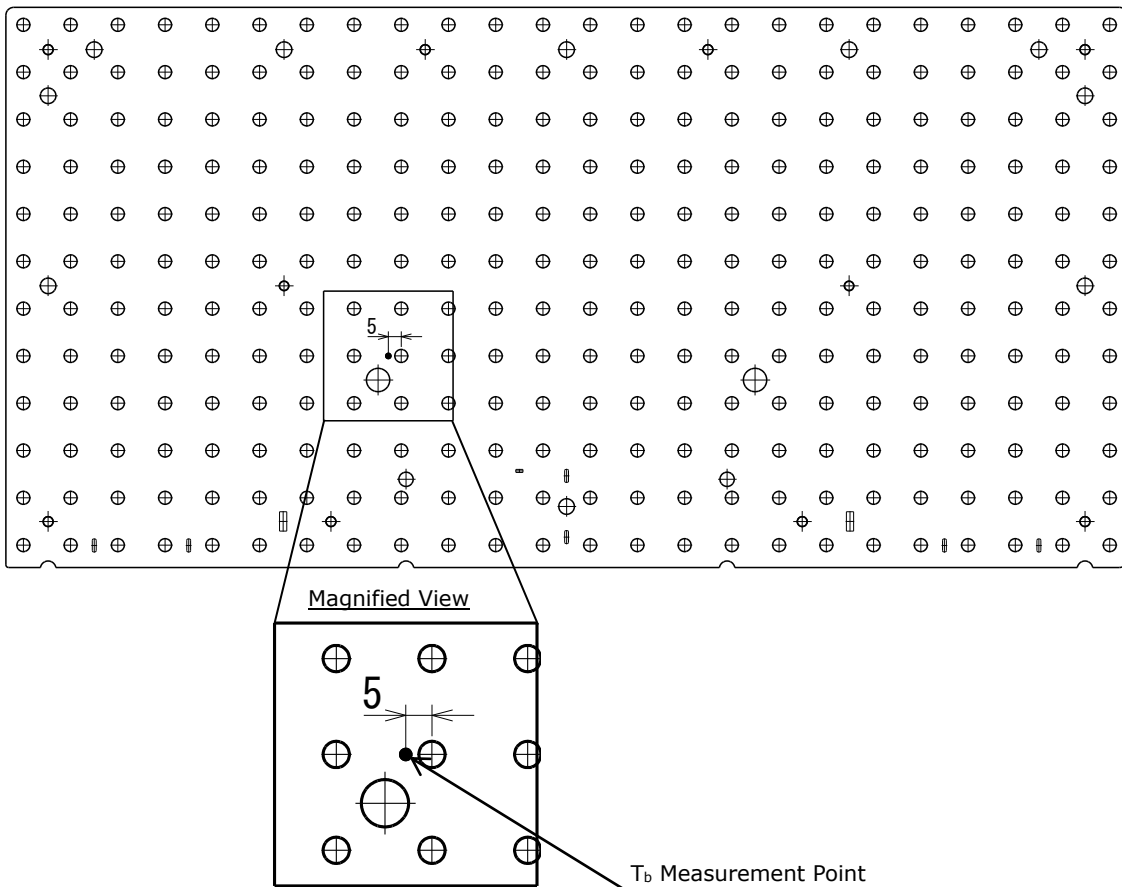

## (6) Electrostatic Discharges (ESD) and Electrical Surges

- The LED chips in this product are sensitive to transient excessive voltages (e.g. ESD, lightning surge). If this excessive voltage occurs in the circuit, it may cause the LED chips to be damaged causing issues (e.g. the product to become dimmer or not to illuminate). Ensure that when handling the product, necessary measures are taken to protect it from ESD. The following examples are recommended measures to eliminate the charge:
  - Grounded wrist strap, ESD footwear, clothes, and floors
  - Grounded workstation equipment and tools
  - ESD table/shelf mat made of conductive materials
- If the tool/equipment used is an insulator (e.g. glass cover, plastic, etc.), ensure that necessary measures have been taken to protect the product from transient excessive voltages (e.g. ESD). The following examples are recommended measures to eliminate the charge:
  - Dissipating static charge with conductive materials
  - Preventing charge generation with moisture
  - Neutralizing the charge with ionizers
- When performing a characteristics inspection for the product that has been assembled into the chosen application, detect if an LED chip was damaged by transient excess voltages (i.e. an ESD event during the application's assembly process).

## (7) Cleaning

- Do not wipe/clean the LEDs with a damp cloth soaked in water or solvents (e.g. benzene, thinner, etc.).
- If cleaning needs be done, use isopropyl alcohol (IPA). If water or other solvent is used, it may cause the PCB and/or resins used in the product to be damaged causing issues; ensure that sufficient verification is performed prior to use. Additionally, ensure that the solvent being used does not cause any other issues (e.g. CFC-based solvents are heavily regulated).
- Do not clean the product with an ultrasonic cleaner. If it must be done, ensure that sufficient verification is performed by using a finished assembly with the product to determine cleaning conditions (e.g. ultrasonic power, how the product is attached to the cleaner) that do not cause an issue.

## (8) Eye Safety

- In 2006, the International Electrical Commission (IEC) published IEC 62471:2006 Photobiological safety of lamps and lamp systems, which added discrete LED components in its scope. On the other hand, the IEC 60825-1:2007 (i.e. Edition 2.0) laser safety standard removed LEDs from its scope. However, be advised that some countries and regions have adopted standards based on the IEC 60825-1:2001 (i.e. Edition 1.2), which still includes discrete LED components in its scope. Most of Nichia's discrete LED components can be classified as belonging into either the Exempt Group or Risk Group 1 according to IEC 62471:2006. However, the classification may be different depending on the characteristics (e.g. radiation flux, emission spectrum, directivity, etc.); ensure that the chosen application using the product is evaluated to determine the classification. Proceed with caution when viewing directly any discrete LED components driven at high current or viewing discrete LED components with optical instruments which may greatly increase the damage to human eyes.
- Viewing a flashing light may cause eye discomfort. When incorporating the product into the chosen application, adverse effects on the human body caused by light stimulation should be taken into consideration.

## (9) Safety Precautions

- If the live parts (e.g. power supply output terminals, resistor, capacitor, etc.) come in contact with the human body when a high voltage is applied to the product, it may cause safety issues (e.g. electrical shock, etc.). When designing the product into an application, ensure that the product is electrically insulated and properly grounded. Additionally, when assembling the chosen application, turn off both the system/assembly and the product to ensure safety.
- The product begins to generate heat that may cause safety issues (e.g. burns, etc.) immediately after the product is energized. Ensure that the system/assembly is designed to avoid contact between the product and surrounding parts/materials (e.g. heatsink, etc.) and the human body.

## (10) Electromagnetic Interference (EMI) Precautions

- This product does not have special protection/shielding against EMI.

## (11) Packaging Materials for Transport

- When transporting the product, the product must be packed in the original packaging or equivalent.



## (12) Environmental Information

- This product uses RoHS-compliant components/materials.
- Ensure that when designing and/or assembling the product into the chosen application, all applicable laws and regulations are followed at all times.
- Ensure that the product or its parts are disposed as industrial waste following all applicable laws and regulations; do not dispose them as general or domestic waste.

## (13) Miscellaneous

- Nichia warrants that the discrete products will meet the requirements/criteria as detailed in the Reliability section within this specification. If the products are used under conditions/environments deviating from or inconsistent with those described in this specification, the resulting damage and/or injuries will not be covered by this warranty.
- Nichia warrants that the discrete product manufactured and/or supplied by Nichia will meet the requirements/criteria as detailed in the Reliability section within this specification; it is the Customer's responsibility to perform sufficient verification prior to use to ensure that the lifetime and other quality characteristics required for the intended use are met. Additionally, even if the product is used under conditions/environments conforming to the foregoing specifications/requirements, Nichia will not be responsible for violation of any law, rule, or regulation directly or indirectly arising from the use of the product.
- The applicable warranty period is one year from the date that the product is delivered. In the case of any incident that appears to be in breach of this warranty, the local Nichia sales representative should be notified to discuss instructions on how to proceed while ensuring that the product in question is not disassembled or removed from the housing if it has been attached to the housing. If a breach of this warranty is proved, Nichia will repair the non-conforming product or provide the replacement for the non-conforming product or an equivalent item free of charge at Nichia's discretion.
- This product is intended to be used for general lighting, household appliances, and electronic devices (e.g. mobile communication devices) LED packages have been used in; it is not designed or manufactured for use in applications that require safety critical functions (e.g. automobiles, trains, vessels, aircraft, spacecraft, submarine repeaters, nuclear reactor control systems, traffic control equipment, combustion equipment, life support systems, safety devices, etc.). If the product is planned to be used for these applications, unless otherwise detailed in the specification, Nichia will neither guarantee that the product is fit for that purpose nor be responsible for any resulting property damage, injuries and/or loss of life/health. This product does not comply with IATF 16949 and is not intended for automotive application.
- This specification contains information which is confidential and/or covered by legal, professional, or other privilege (e.g. patents, copyrights, trade secrets, and trademarks, etc.) and is intended solely to provide information regarding the product. Nichia prohibits use of this specification for any other purpose than those expressed. Without prior written permission from Nichia, no part of this specification may be reproduced, distributed, disclosed, or transmitted in any form or by any means.
- This specification contains information which is confidential and/or covered by legal, professional, or other privilege (e.g. patents, copyrights, trade secrets, and trademarks, etc.) and is intended solely to provide information regarding the product. Nichia prohibits use of this specification for any other purpose than those expressed. Without prior written permission from Nichia, no part of this specification may be reproduced, distributed, disclosed, or transmitted in any form or by any means.
- Without prior written permission from Nichia, the Customer will not reverse engineer, disassemble or otherwise attempt to extract knowledge/design information from the product. In the case of any incident that appears not to conform to the foregoing specifications, the local Nichia sales representative should be notified to discuss instructions on how to proceed while ensuring that the product in question is not disassembled.
- Both the Customer and Nichia will agree on the official specifications for the supplied products before any programs are officially launched. Without this agreement in writing (i.e. Customer Specific Specification), changes to the content of this specification may occur without notice (e.g. changes to the foregoing specifications and appearance, discontinuation of the products, etc.).