

**NICHIA CORPORATION**

**SPECIFICATIONS FOR WHITE LED**

**PART NO. NVCWJ024Z-V1MT**

**(Rce00ce Spec.)**

- Built-in ESD Protection Device
- RoHS Compliant

This is an LED that contains two phosphor-coated (PC) LED die and the color temperature of this LED can be adjusted to be between 2700K to 5000K by changing the ratio of the current flowing through the two LED die (i.e. 2-in-1 tunable white LED).

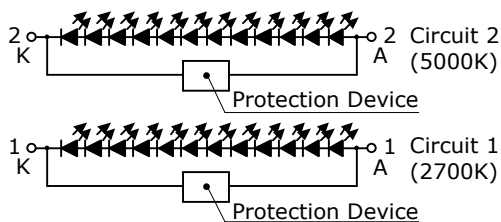
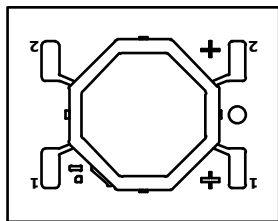

Circuit 2: An internal circuit containing a PC LED die with a CCT of 5000K

Circuit 1: An internal circuit containing a PC LED die with a CCT of 2700K

## SPECIFICATIONS

### (1) Absolute Maximum Ratings

| Item                        | Symbol        | Absolute Maximum Rating |                  | Unit |
|-----------------------------|---------------|-------------------------|------------------|------|
|                             |               | Circuit 2(5000K)        | Circuit 1(2700K) |      |
| Forward Current             | $I_F$         | 1500                    | 1500             | mA   |
| Pulse Forward Current       | $I_{FP}$      | 2100                    | 2100             | mA   |
| Allowable Reverse Current   | $I_R$         | 85                      | 85               | mA   |
| Total Forward Current       | $I_{F\_TOT}$  | 1500                    |                  | mA   |
| Total Pulse Forward Current | $I_{FP\_TOT}$ | 2100                    |                  | mA   |
| Total Power Dissipation     | $P_{TOT}$     | 115                     |                  | W    |
| Operating Temperature       | $T_{opr}$     | -40~105                 |                  | °C   |
| Storage Temperature         | $T_{stg}$     | -40~100                 |                  | °C   |
| Junction Temperature        | $T_J$         | 150                     |                  | °C   |

\* Absolute Maximum Ratings at  $T_J=25^\circ\text{C}$ .

\*  $I_{FP}$  and  $I_{FP\_TOT}$  conditions with pulse width  $\leq 10\text{ms}$  and duty cycle  $\leq 10\%$ .

\* Since the actual  $I_F$ ,  $I_{FP}$ ,  $I_{F\_TOT}$ , and  $I_{FP\_TOT}$  values may change depending on the operating conditions (i.e.  $T_A$  and duty cycle), refer to the Derating Characteristics section when designing for the chosen application.

\* The values for the  $I_F$ ,  $I_{FP}$ , and  $I_R$  are only values of the LEDs for single-circuit operation.

\* The values for the  $I_{F\_TOT}$ ,  $I_{FP\_TOT}$ , and  $P_{TOT}$  values are only values for simultaneous dual-circuit operation.

\* The operating Temperature ( $T_{opr}$ ) range is the range of case temperatures.

## (2) Initial Electrical/Optical Characteristics

| Item            | Symbol                | Circuit 2(5000K)   | Circuit 1(2700K)   | Unit   |        |   |
|-----------------|-----------------------|--|--|--------|--------|---|
|                 |                       | Condition  |  |        |        |   |
|                 |                       | Circuit 1: I <sub>F</sub> =0mA<br>Circuit 2: I <sub>F</sub> =600mA | Circuit 1: I <sub>F</sub> =600mA<br>Circuit 2: I <sub>F</sub> =0mA |        |        |   |
|                 |                       | Typ  | Typ  |        |        |   |
| Forward Voltage | V <sub>F</sub>        | 35.4   | 35.4   | V      |        |   |
| Rce00ce         | Luminous Flux         | Φ <sub>v</sub>   | 2730   | 2080   | lm     |   |
|                 | Color Rendering Index | R <sub>a</sub>   | 93   | 93     | -      |   |
|                 | Chromaticity          | x  | -  | 0.3447 | 0.4540 | - |
|                 | Coordinate            | y  |  | 0.3553 | 0.4000 |   |

| Item               | Symbol           | Condition | Typ  | Max  | Unit |
|--------------------|------------------|-----------|------|------|------|
| Thermal Resistance | R <sub>θJC</sub> | -         | 0.53 | 0.58 | °C/W |

- \* Characteristics at T<sub>J</sub>=25°C and measured in pulse mode.
- \* Optical Characteristics as per CIE 127:2007 standard.
- \* Chromaticity Coordinates as per CIE 1931 Chromaticity Chart.
- \* The values for the V<sub>F</sub>, Φ<sub>v</sub>, R<sub>a</sub>, chromaticity coordinates, and thermal resistance (R<sub>θJC</sub>) in the above table are only values for single-circuit operation.
- \* R<sub>θJC</sub> is measured using the Dynamic Mode detailed in JESD51-1.
- \* R<sub>θJC</sub> is the thermal resistance from the junction to the T<sub>C</sub> measurement point.
- \* R<sub>θJC</sub> is the thermal resistance when a thermal grease is used. If a thermal film/sheet is used, the R<sub>θJC</sub> may be significantly larger than this R<sub>θJC</sub>.
- \* For more details on thermal resistance, see CAUTIONS, (6) Thermal Management.
- \* For more details on calculation of junction temperature, see CAUTIONS, (6) Thermal Management.

**Refer to the relevant application notes for detailed information (e.g. how to handle the COB LEDs, the effect of adhesion strength between the COB and the housing, thermal design considerations, etc.). To access the application notes, go to the Technical Suggestions And Recommendations section of Nichia's website.**

## RANKS

| Item                  | Rank       | Circuit 2(5000K)   |      | Circuit 1(2700K)   |      | Unit |   |
|-----------------------|------------|--|------|--|------|------|---|
|                       |            | Condition  |      |  |      |      |   |
|                       |            | Circuit 1: I <sub>F</sub> =0mA<br>Circuit 2: I <sub>F</sub> =600mA |      | Circuit 1: I <sub>F</sub> =600mA<br>Circuit 2: I <sub>F</sub> =0mA |      |      |   |
|                       |            | Min  | Max  | Min  | Max  |      |   |
| Forward Voltage       | -          | 33.0   | 38.4 | 33.0   | 38.4 | V    |   |
| Luminous Flux         | Qa02460188 | 2460   | 3020 | 1880   | 2300 | lm   |   |
| Color Rendering Index | Rce00ce    | R <sub>a</sub>   | 90   | -  | 90   | -    | - |
|                       |            | R <sub>9</sub>   | 50   | -  | 50   | -    |   |

### Color Rank

The color rank has a chromaticity range within a 3-step MacAdam ellipse.

|                             |                 | Rank   |  |
|-----------------------------|-----------------|--|--|
|                             |                 | 50300273g  |  |
|                             |                 | Circuit 2(5000K)   | Circuit 1(2700K)   |
|                             |                 | Condition  |  |
|                             |                 | Circuit 1: I <sub>F</sub> =0mA<br>Circuit 2: I <sub>F</sub> =600mA | Circuit 1: I <sub>F</sub> =600mA<br>Circuit 2: I <sub>F</sub> =0mA |
| Color Temperature (Unit: K) | T <sub>CP</sub> | 5000   | 2700   |
| Center Point                | x               | 0.3447   | 0.4540   |
|                             | y               | 0.3553   | 0.4000   |
| Minor Axis                  | a               | 0.003555   | 0.004077   |
| Major Axis                  | b               | 0.008418   | 0.007992   |
| Ellipse Rotation Angle      | Φ               | -31.78   | -38.96   |

\* Ranking at T<sub>J</sub>=25°C and measured in pulse mode.

\* Forward Voltage Tolerance: ±0.35V

\* Luminous Flux Tolerance: ±5%

\* Color Rendering Index R<sub>a</sub> Tolerance: ±2

\* Color Rendering Index R<sub>9</sub> Tolerance: ±6.5

\* Chromaticity Coordinate Tolerance: ±0.003

\* The values for the Forward Voltage, Luminous Flux, R<sub>a</sub>, and R<sub>9</sub> for the Circuit 2 (5000K) and Circuit 1 (2700K) columns are only values of the LEDs for single-circuit operation.

## CHROMATICITY DIAGRAM

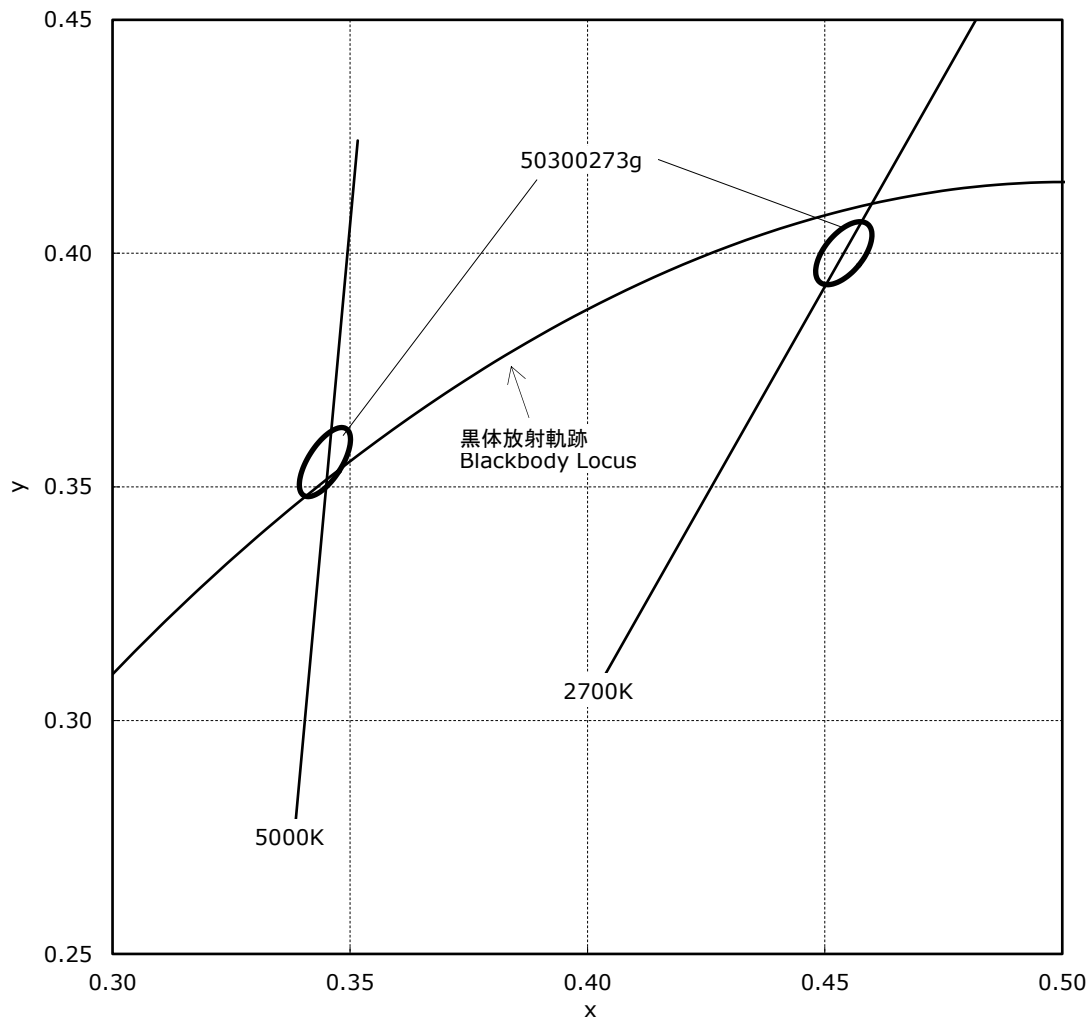

調色後の色度は2つの色度範囲(5000K, 2700K)を結んだ線上にできるため、黒体放射軌跡から離れることがあります。

When the LED color is being adjusted by operating both PC LED die (i.e. 2700K and 5000K) the white color that is created will be along a straight line between those color points.

# OUTLINE DIMENSIONS

\* 本製品はRoHS指令に適合しております。  
This product complies with RoHS Directive.

Part No. NVCWJ024Z-V1MT  
No. STS-DA7-14398A

\* 括弧で囲まれた寸法は参考値です。  
The dimension(s) in parentheses are for reference purposes.

(単位 Unit: mm, 公差 Tolerance: ±0.3)

光学的中心位置  
Location of the optical center  
発光部中心の位置精度 ±0.3mm  
The center of emitting area to be centered ±0.3mm.

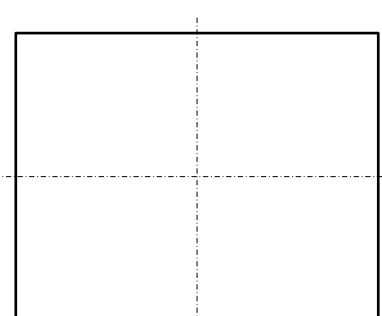
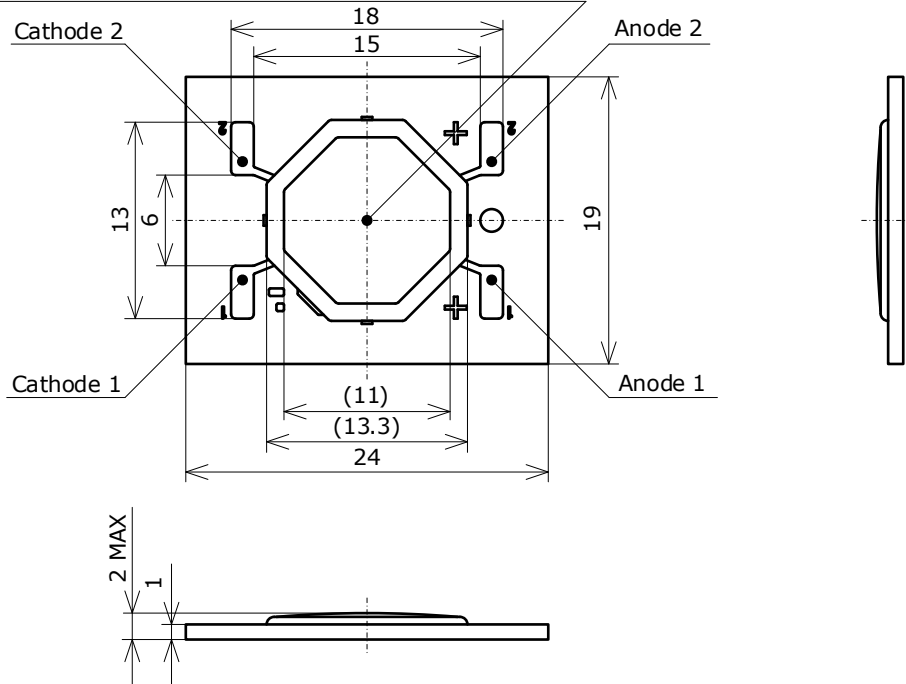

| 項目 Item                                 | 内容 Description  |
|---|---|
| パッケージ材質<br>Package Materials            | セラミックス<br>Ceramics  |
| 封止樹脂材質<br>Encapsulating Resin Materials | シリコン樹脂<br>(拡散剤+蛍光体入り)<br>Silicone Resin<br>(with diffuser and phosphor) |
| 電極材質<br>Electrodes Materials            | 金メッキ<br>Au-plated   |
| 質量<br>Weight                            | 1.8g(TYP)   |

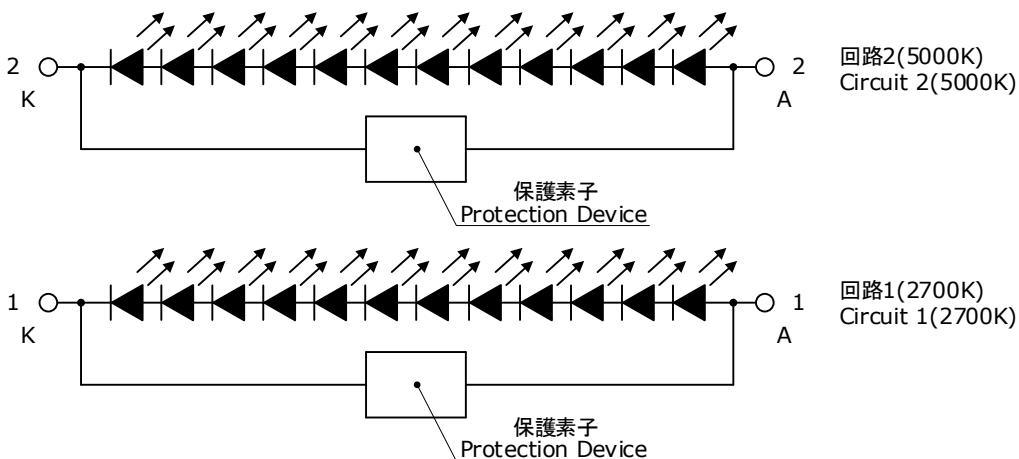

## SOLDERING

- Recommended Hand Soldering Condition

|                |           |
|----------------|-----------|
| Temperature    | 380°C Max |
| Soldering Time | 5sec Max  |

- \* Hand soldering must not be performed more than once.
- \* This LED uses a silicone resin for the encapsulating resin frame or resin area; the silicone resin is soft. If excess pressure is applied to the silicone resin, it may cause the resin to be damaged, chipped, cracked and/or deformed. If the encapsulating resin frame and/or resin area are damaged, chipped, cracked and/or deformed, it may cause the wire to break causing a catastrophic failure (i.e. the LED not to illuminate) and/or reliability issues (e.g. the LED to corrode and/or to become dimmer, the color directivity to change, etc.).
- \* Repairing should not be done after the LEDs have been soldered. It should be confirmed beforehand whether the characteristics of the LEDs will or will not be damaged by repairing.
- \* When soldering, do not apply stress to the LED while the LED is hot.
- \* When using an automatic pick-and-place machine, choose an appropriate nozzle for this LED. Using a pick-and-place nozzle with a smaller diameter than the size of the LED's emitting surface will cause damage to the emitting surface causing a catastrophic failure (i.e. the LED not to illuminate).
- \* When flux is used, it should be a halogen free flux. Ensure that the manufacturing process is not designed in a manner where the flux will come in contact with the LEDs.
- \* During and/or after soldering an electric wire to the electrode, ensure that tension is not applied to the electric wire. This may cause the electrode to be damaged and/or reduce the adhesive strength of the electrode to the package.
- \* If soldering is used to join electric wires to the electrodes, the adhesive strength of the electrode to the package may be reduced depending on the substances that are found in the solder paste and/or the type of the wire cover that is used. Ensure that there are no issues with the materials that will be used in the chosen application prior to use.

# TRAY DIMENSIONS

\* 数量は1トレイにつき 42個入りです。  
 Tray Size: 42pcs

NxxxJ024x  
 管理番号 No. STS-DA7-14399

\* 寸法は参考です。  
 All dimensions shown are for reference only and are not guaranteed.

(単位 Unit: mm)

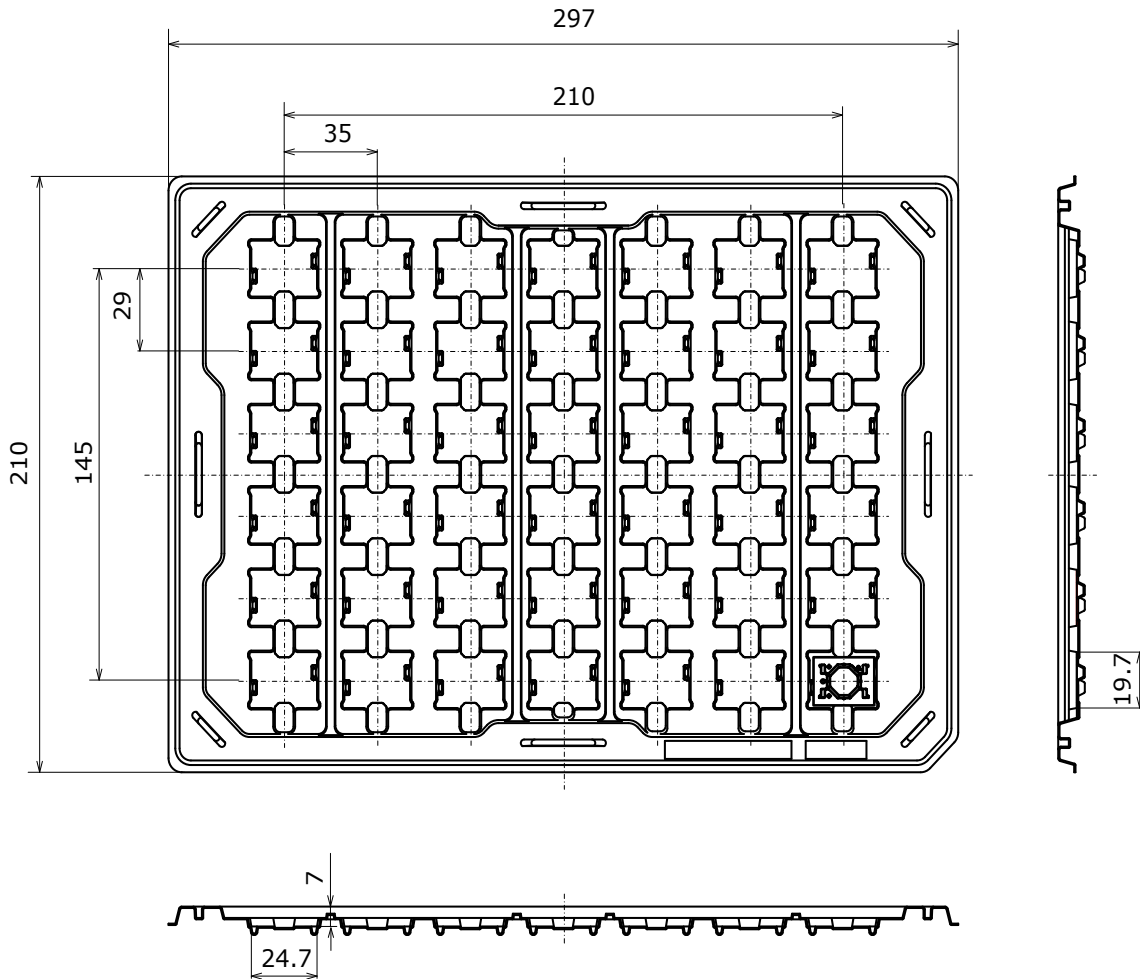



## PACKAGING - TRAY PACK

Trays are shipped with desiccants in heat-sealed moisture-proof bags.  
シリカゲルとともにトレイをアルミ防湿袋に入れ、熱シールにより封をします。

Part No. Nxxxxxxx  
No. STS-DA7-5106D

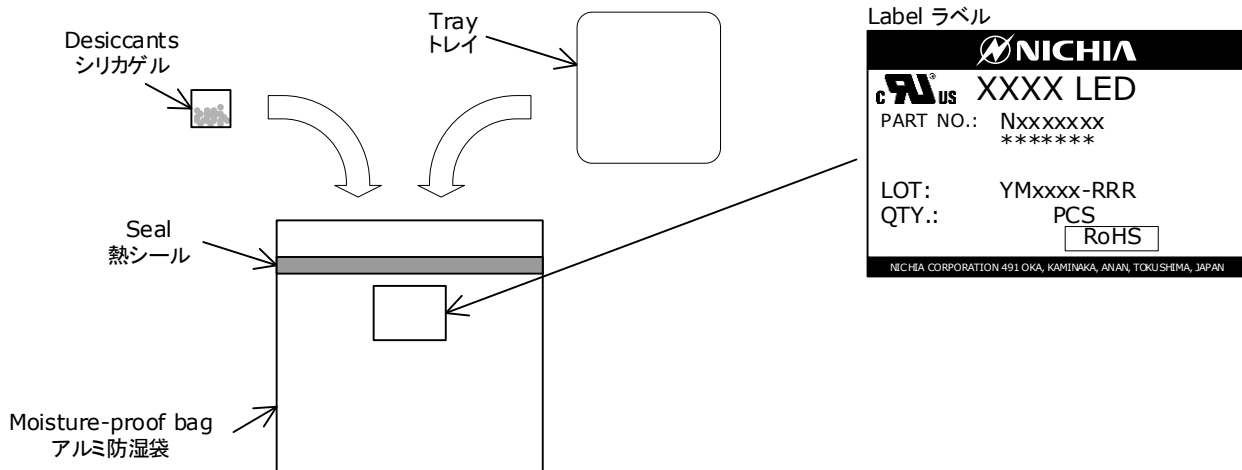

Moisture-proof bags are packed in cardboard boxes with corrugated partitions.  
アルミ防湿袋を並べて入れ、ダンボールで仕切ります。

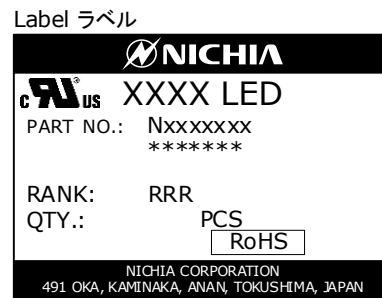
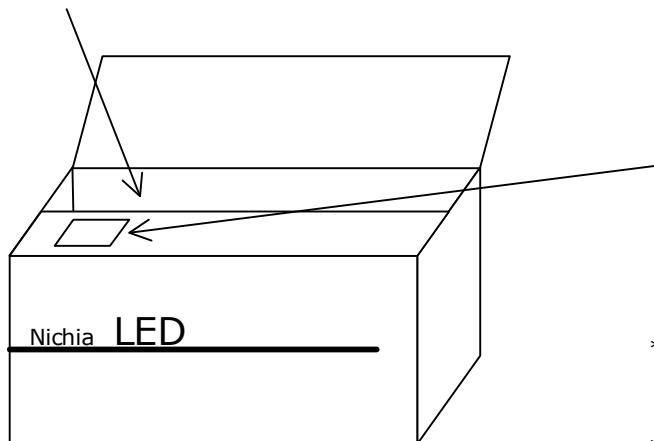

- \* \*\*\*\*\* is the customer part number.  
If not provided, it will not be indicated on the label.  
客先型名を\*\*\*\*\*で示します。  
客先型名が設定されていない場合は空白です。
- \* For details, see "LOT NUMBERING CODE" in this document.  
ロット表記方法についてはロット番号の項を参照して下さい。

- \* Products shipped on trays are packed in a moisture-proof bag.  
They are shipped in cardboard boxes to protect them from external forces during transportation.  
本製品はトレイに入れたのち、輸送の衝撃から保護するためダンボールで梱包します。
- \* Do not drop or expose the box to external forces as it may damage the products.  
取り扱いに際して、落下させたり、強い衝撃を与えたりしますと、製品を損傷させる原因になりますので注意して下さい。
- \* Do not expose to water. The box is not water-resistant.  
ダンボールには防水加工がされておりませんので、梱包箱が水に濡れないよう注意して下さい。
- \* Using the original package material or equivalent in transit is recommended.  
輸送、運搬に際して弊社よりの梱包状態あるいは同等の梱包を行って下さい。

## LOT NUMBERING CODE

Lot Number is presented by using the following alphanumeric code.

YMxxxx - RRR

Y - Year

| Year | Y |
|------|---|
| 2020 | K |
| 2021 | L |
| 2022 | M |
| 2023 | N |
| 2024 | O |
| 2025 | P |

M - Month

| Month | M | Month | M |
|-------|---|-------|---|
| 1     | 1 | 7     | 7 |
| 2     | 2 | 8     | 8 |
| 3     | 3 | 9     | 9 |
| 4     | 4 | 10    | A |
| 5     | 5 | 11    | B |
| 6     | 6 | 12    | C |

xxxx-Nichia's Product Number

RRR-Ranking by Color Coordinates, Ranking by Luminous Flux, Ranking by Color Rendering Index

# DERATING CHARACTERISTICS

Part No. NVCWJ024Z-V1MT  
No. STS-DA7-16088A

**Temperature at Measure Point on a Case vs Allowable Forward Current, Total Allowable Forward Current**  
ケース温度測定部温度-許容順電流、全許容順電流特性

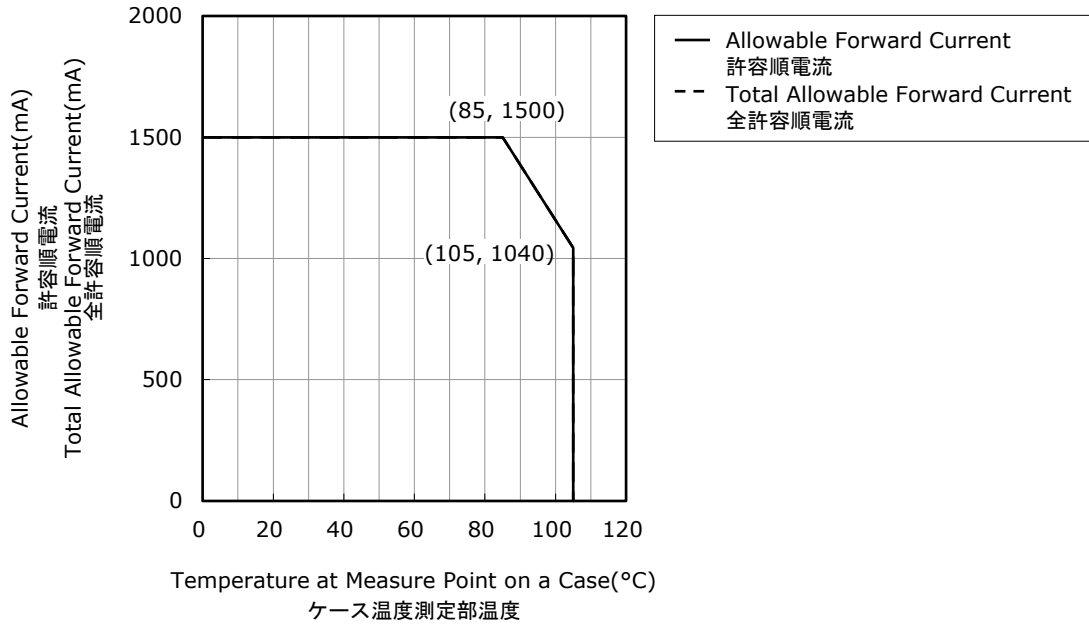

**Duty Ratio vs Allowable Forward Current, Total Allowable Forward Current**  
デューティー比-許容順電流、全許容順電流特性

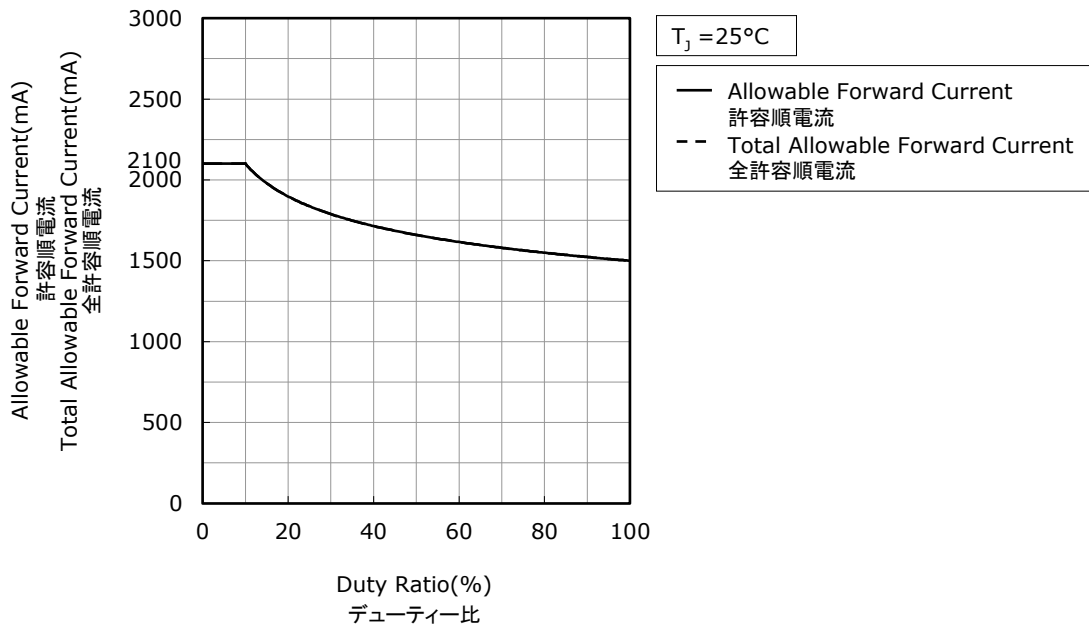

# OPTICAL CHARACTERISTICS

- \* All characteristics shown are for reference only and are not guaranteed.  
本特性は参考です。
- \* The following graphs show the characteristics measured in pulse mode.  
パルス駆動により測定しています。

Part No. NVCWJ024Z-V1MT  
No. STS-DA7-16084A

## Spectrum 発光スペクトル

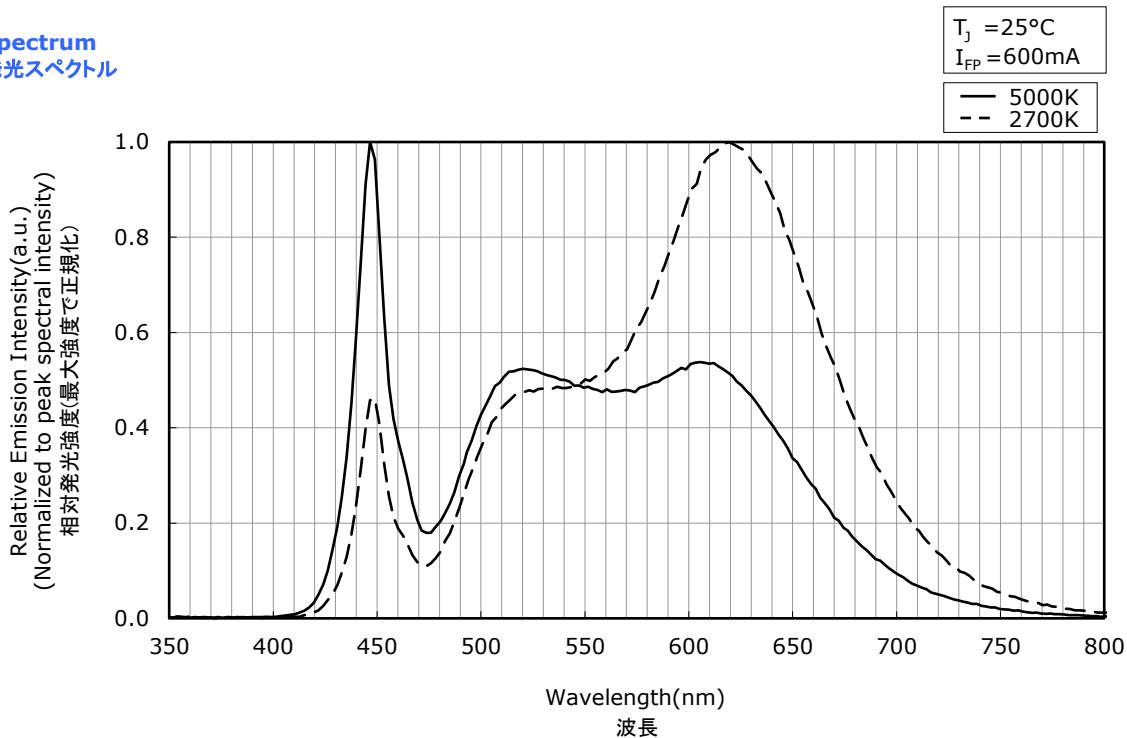

## Directivity 指向特性

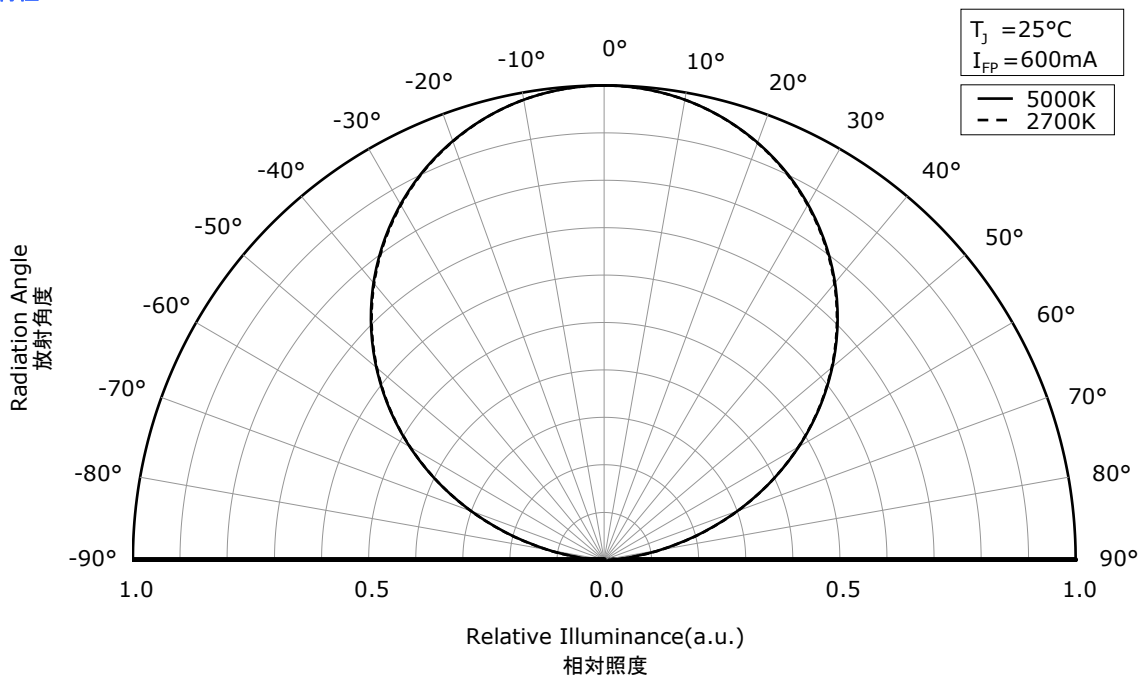

- \* The graphs above show the characteristics for Rce00ce LEDs of this product.  
本特性は演色性ランクRce00ceに対応しています。

# FORWARD CURRENT CHARACTERISTICS / TEMPERATURE CHARACTERISTICS

- \* All characteristics shown are for reference only and are not guaranteed.  
本特性は参考です。
- \* The following graphs show the characteristics measured in pulse mode.  
パルス駆動により測定しています。

Part No. NVCWJ024Z-V1MT  
No. STS-DA7-16085A

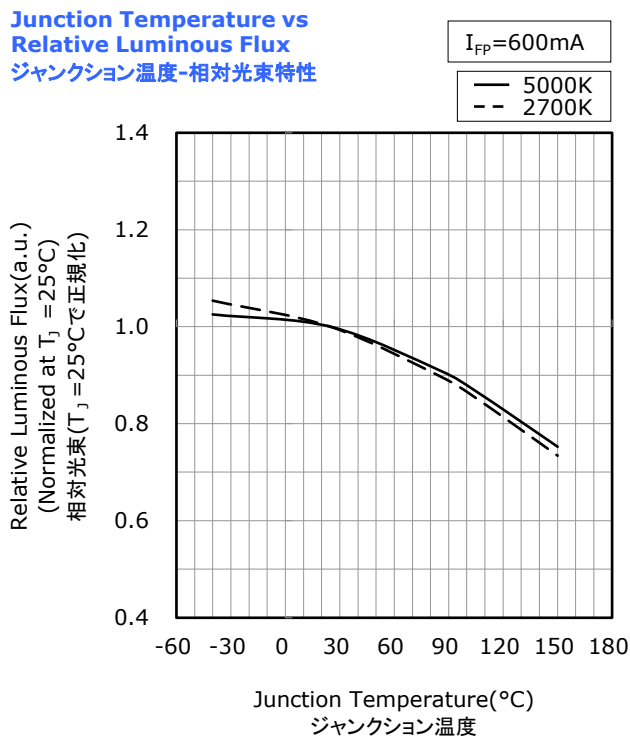
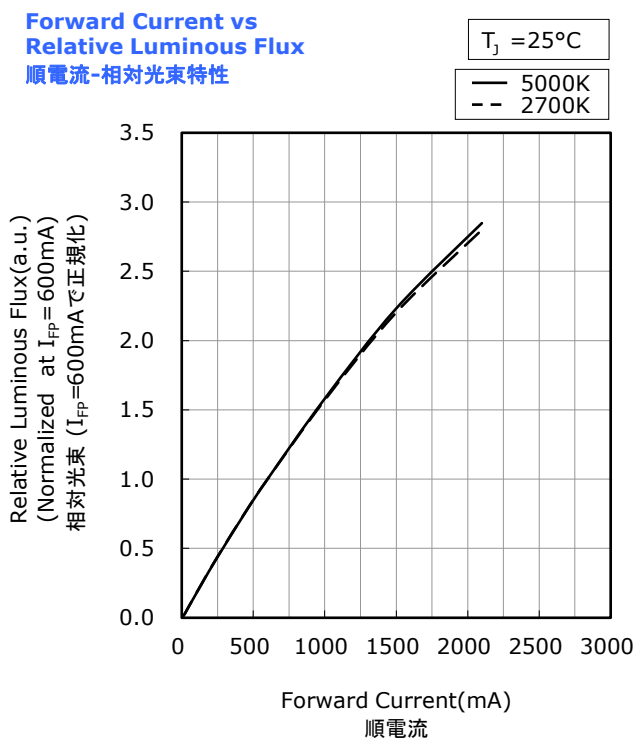
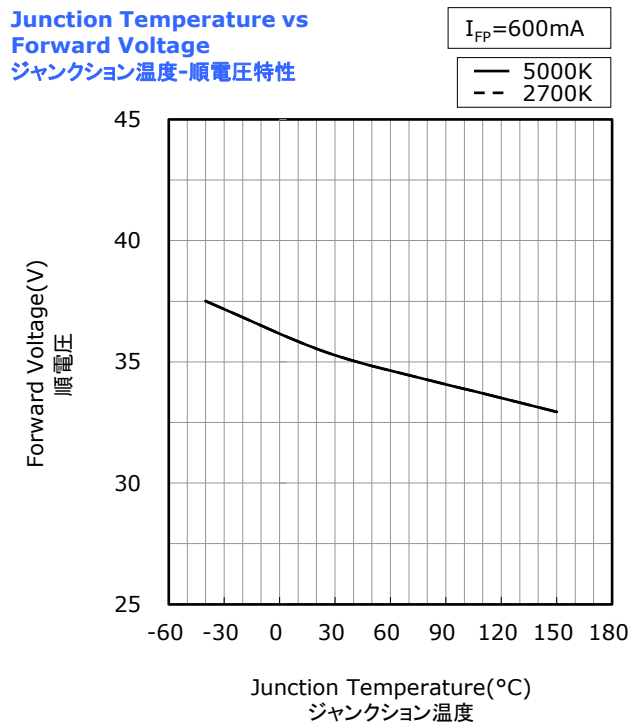
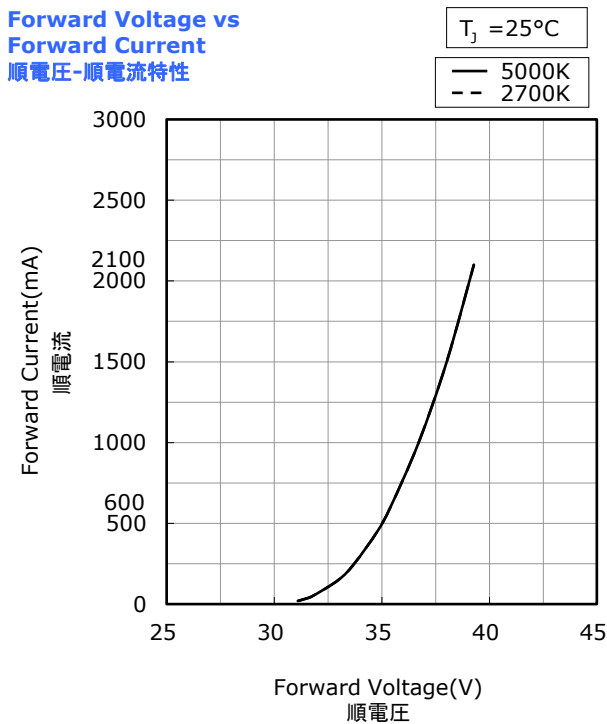

- \* The graphs above show the characteristics for Rce00ce LEDs of this product.  
本特性は濁色性ランクRce00ceに対応しています。

## FORWARD CURRENT CHARACTERISTICS / TEMPERATURE CHARACTERISTICS

- \* All characteristics shown are for reference only and are not guaranteed.  
本特性は参考です。
- \* The following graphs show the characteristics measured in pulse mode.  
パルス駆動により測定しています。

Part No. NVCWJ024Z-V1MT  
No. STS-DA7-16086A

**Forward Current vs Chromaticity Coordinate**  
順電流-色度 特性

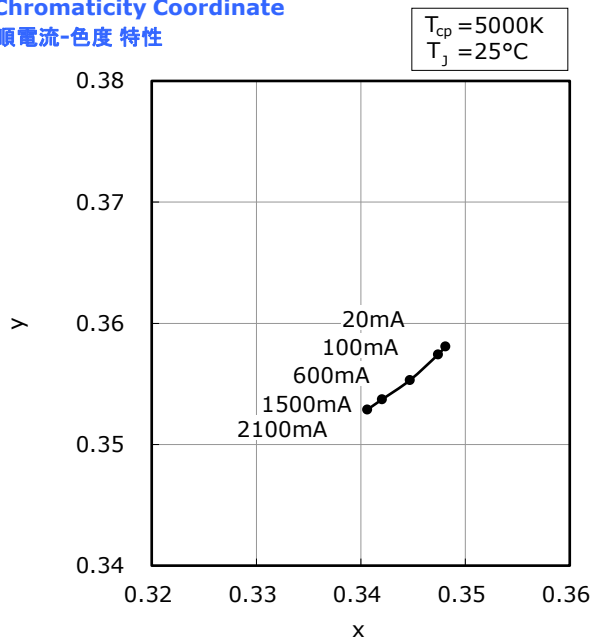

**Junction Temperature vs Chromaticity Coordinate**  
ジャンクション温度-色度 特性

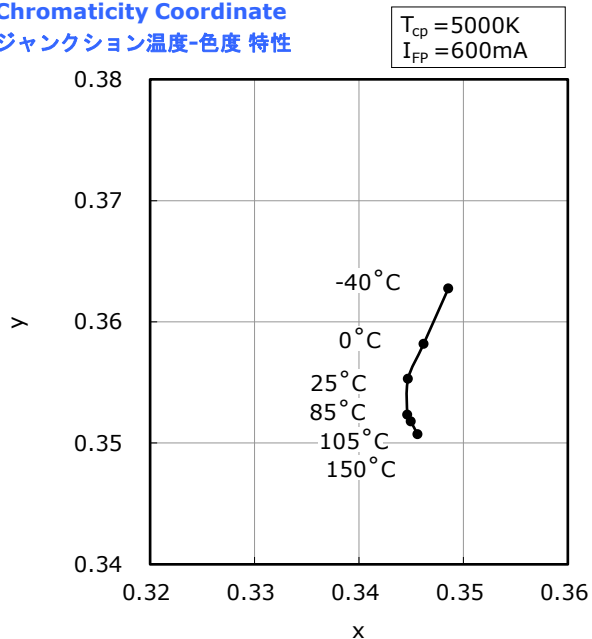

- \* The graphs above show the characteristics for Rce00ce LEDs of this product.  
本特性は演色性ランクRce00ceに対応しています。

## FORWARD CURRENT CHARACTERISTICS / TEMPERATURE CHARACTERISTICS

- \* All characteristics shown are for reference only and are not guaranteed.  
本特性は参考です。
- \* The following graphs show the characteristics measured in pulse mode.  
パルス駆動により測定しています。

Part No. NVCWJ024Z-V1MT  
No. STS-DA7-16087A

**Forward Current vs Chromaticity Coordinate**  
順電流-色度 特性

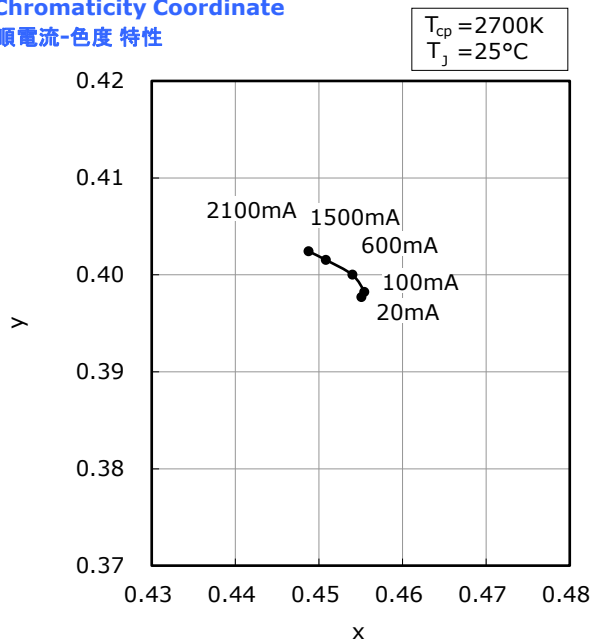

**Junction Temperature vs Chromaticity Coordinate**  
ジャンクション温度-色度 特性

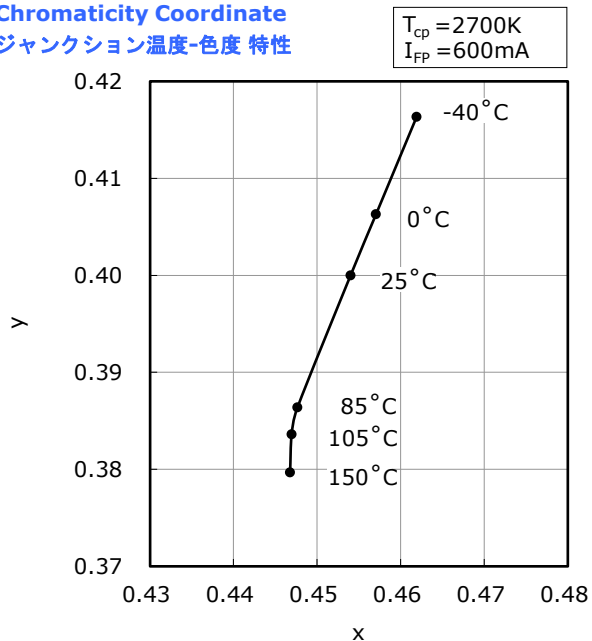

- \* The graphs above show the characteristics for Rce00ce LEDs of this product.  
本特性は演色性ランクRce00ceに対応しています。

## RELIABILITY

### (1) Tests and Results

| Test                            | Reference Standard       | Test Conditions   |   | Test Duration | Failure Criteria # | Units Failed/Tested |
|---------------------------------|--------------------------|---|---|---------------|--------------------|---------------------|
| Thermal Shock(Air to Air)       |                          | -40°C to 100°C, 15min dwell                                       |   | 100cycles     | #1                 | 0/10                |
| High Temperature Storage        | JEITA ED-4701<br>200 201 | T <sub>A</sub> =100°C   |   | 1000hours     | #1                 | 0/10                |
| Temperature Humidity Storage    | JEITA ED-4701<br>100 103 | T <sub>A</sub> =60°C, RH=90%                                      |   | 1000hours     | #1                 | 0/10                |
| Low Temperature Storage         | JEITA ED-4701<br>200 202 | T <sub>A</sub> =-40°C   |   | 1000hours     | #1                 | 0/10                |
| High Temperature Operating Life |                          | T <sub>C</sub> =85°C  | 5000K: I <sub>F</sub> =1500mA<br>2700K: I <sub>F</sub> =0mA | 1000hours     | #1                 | 0/10                |
|                                 |                          |   | 5000K: I <sub>F</sub> =0mA<br>2700K: I <sub>F</sub> =1500mA | 1000hours     | #1                 | 0/10                |
| Electrostatic Discharges        | JEITA ED-4701<br>300 304 | HBM, 2kV, 1.5kΩ, 100pF, 3pulses, alternately positive or negative |   |               | #1                 | 0/10                |

#### NOTES:

Measurements are performed after allowing the LEDs to return to room temperature.

### (2) Failure Criteria

| Criteria # | Items                            | Conditions            | Failure Criteria   |
|------------|----------------------------------|-----------------------|--------------------|
| #1         | Forward Voltage(V <sub>F</sub> ) | I <sub>F</sub> =600mA | >Initial value×1.1 |
|            | Luminous Flux(Φ <sub>v</sub> )   | I <sub>F</sub> =600mA | <Initial value×0.7 |

\* The failure criteria for the V<sub>F</sub> and Φ<sub>v</sub> in the above table are values only for single-circuit operation.



## CAUTIONS

### (1) Storage

| Conditions |                             | Temperature | Humidity | Time                             |
|------------|-----------------------------|-------------|----------|----------------------------------|
| Storage    | Before Opening Aluminum Bag | ≤30°C       | ≤90%RH   | Within 1 Year from Delivery Date |
|            | After Opening Aluminum Bag  | ≤30°C       | ≤70%RH   | ≤168hours                        |

- Once the moisture-proof aluminum bag is open, ensure that the LED is soldered to a PCB within the range of the conditions above. To store any remaining unused LEDs, use a hermetically sealed container with silica gel desiccants. Nichia recommends placing them back to the original moisture-proof bag and reseal it.
- This LED has gold-plated electrodes. If the LEDs are exposed to a corrosive environment, it may cause the plated surface to tarnish causing issues. Ensure that when storing LEDs, a hermetically sealed container is used. Nichia recommends placing them back to the original moisture-proof bag and reseal it.
- To prevent substances/gases from affecting the plated surface, ensure that the parts/materials used with the LEDs in the same assembly/system do not contain sulfur (e.g. gasket/seal, adhesive, etc.). If the plating is contaminated, it may cause issues (e.g. electric connection failures). If a gasket/seal is used, silicone rubber gaskets/seals are recommended; ensure that this use of silicone does not result in issues (e.g. electrical connection failures) caused by low molecular weight volatile siloxane.
- To avoid condensation, the LEDs must not be stored in areas where temperature and humidity fluctuate greatly.
- Do not store the LEDs in a dusty environment.
- Do not expose the LEDs to direct sunlight and/or an environment over a long period of time where the temperature is higher than normal room temperature.

### (2) Directions for Use

- Operating at a constant current per circuit is recommended. In case of operating at a constant voltage, Circuit B is recommended. As for Circuit A, the current may not be stable due to the variation of the Forward Voltage characteristic of the LED.

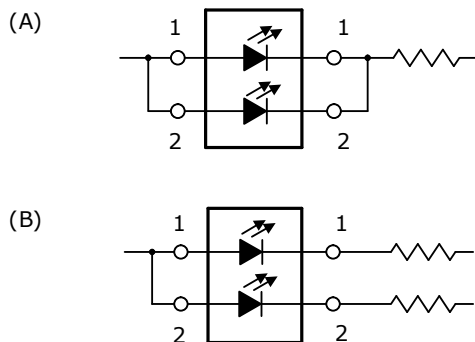

- This LED is designed to be operated at a forward current. Ensure that no voltage is applied to the LED in the forward/reverse direction while the LED is off. If the LEDs are used in an environment where reverse voltages are applied to the LED continuously, it may cause electrochemical migration to occur causing the LED to be damaged. When not in use for a long period of time, the system's power should be turned off to ensure that there are no issues/damage.
- When using the LEDs with a dimmer, the color may vary depending on the current through the LED; it is recommended to operate the LED with pulse width modulation (PWM) to minimize this issue.
- To stabilize the LED characteristics while in use, Nichia recommends that the LEDs are operated at currents  $\geq 10\%$  of the sorting current.
- Ensure that transient excessive voltages (e.g. lightning surge) are not applied to the LEDs.
- If the LEDs are used for outdoor applications, ensure that necessary measures are taken (e.g. protecting the LEDs from water/salt damage and high humidity).

### (3) Handling Precautions

- Do not handle the LEDs with bare hands:
  - this may contaminate the LED surface and have an effect on the optical characteristics,
  - this may cause the LED to deform and/or the wire to break causing a catastrophic failure (i.e. the LED not to illuminate).
- Ensure that when handling the LEDs with tweezers, excessive force is not applied to the LED. Otherwise, it may cause damage to the resin (e.g. cut, scratch, chip, crack, delamination and deformation) and the wire to break causing a catastrophic failure (i.e. the LED not to illuminate).
- Dropping may cause damage to the LED (e.g. deformation).
- Do not stack the LEDs. Otherwise, it may cause damage to the resin (e.g. cut, scratch, chip, crack, delamination and deformation) and the wire to break causing a catastrophic failure (i.e. the LED not to illuminate).

### (4) Design Consideration

- Volatile organic compounds that have been released from materials present around the LEDs (e.g. housing, gasket/seal, adhesive, secondary lens, lens cover, grease, etc.) may penetrate the LED emitting surface. If the LEDs are being used in a hermetically/near-hermetically sealed environment, these volatile compounds can discolor after being exposed to heat and/or photon energy and it may greatly reduce the LED light output and/or color shift. In this case, ventilating the environment may improve the reduction in light output and/or color shift. Perform a light-up test of the chosen application for optical evaluation prior to use to ensure that there are no issues, this test should be performed taking into consideration the conditions/environments in which the end-product containing these LEDs will actually be used.
- The characteristics of the LEDs (e.g. chromaticity, color rendering index, etc.) will vary depending on how the LEDs are designed into the application (e.g. secondary lens, luminaire cover/housing, etc. for ease of dissipation), how they were assembled, under what conditions/environments they are used (e.g. operating current/temperature, etc.), and how long they have been used (e.g. storage/operating hours, etc.). To ensure that there are no issues (e.g. deviations/changes in the characteristics, etc.) with the chosen application, perform a sufficient verification prior to use.
- This LED uses a ceramic material for the substrate; if the LED is attached to a housing in an inappropriate manner (e.g. uneven application of force to the ceramic substrate, unstable holding, etc.), it may cause the substrate to crack. Nichia recommends using a specially designed holder to attach the LEDs to a housing.
- Nichia recommends using a thermal grease for the interface between the LED and housing. If the LEDs are attached to a housing without a thermal interface material, it may cause the heat dissipation to decrease; additionally, if a thermal film/sheet is used as the thermal interface material, the  $R_{\theta JC}$  may be significantly larger than the specified  $R_{\theta JC}$ .

**Refer to the relevant application notes for detailed information (e.g. how to handle the COB LEDs, the effect of adhesion strength between the COB and the housing, thermal design considerations, etc.). To access the application notes, go to the Technical Suggestions And Recommendations section of Nichia's website.**

### (5) Electrostatic Discharge (ESD)

- This LED is sensitive to transient excessive voltages (e.g. ESD, lightning surge). If this excessive voltage occurs in the circuit, it may cause the LED to be damaged causing issues (e.g. the LED to become dimmer or not to illuminate [i.e. catastrophic failure]). Ensure that when handling the LEDs, necessary measures are taken to protect them from an ESD discharge. The following examples are recommended measures to eliminate the charge:
  - Grounded wrist strap, ESD footwear, clothes, and floors
  - Grounded workstation equipment and tools
  - ESD table/shelf mat made of conductive materials
- Ensure that all necessary measures are taken to prevent the LEDs from being exposed to transient excessive voltages (e.g. ESD, lightning surge):
  - tools (e.g. soldering irons), jigs, and machines that are used are properly grounded
  - appropriate ESD materials/equipment are used in the work area
  - the system/assembly is designed to provide ESD protection for the LEDs.
- If the tool/equipment used is an insulator (e.g. glass cover, plastic, etc.), ensure that necessary measures have been taken to protect the LED from transient excessive voltages (e.g. ESD). The following examples are recommended measures to eliminate the charge:
  - Dissipating static charge with conductive materials
  - Preventing charge generation with moisture
  - Neutralizing the charge with ionizers

## (6) Thermal Management

- When using this product, ensure that proper thermal management is provided and the die temperature does not exceed the maximum Junction Temperature ( $T_J$ ). The temperature at the LED junction, once the saturation temperature has been reached, can be calculated using the following equation:

$$T_J = T_C + R_{\theta JC} \cdot W$$

\* $T_J$  = LED Junction Temperature: °C

$T_C$  = Case Temperature: °C

$R_{\theta JC}$  = Thermal Resistance from Junction to  $T_C$  Measurement Point: °C/W

$W$  = Input Power of circuit 1 ( $I_F \times V_F$ ) + Input Power of circuit 2 ( $I_F \times V_F$ ): W

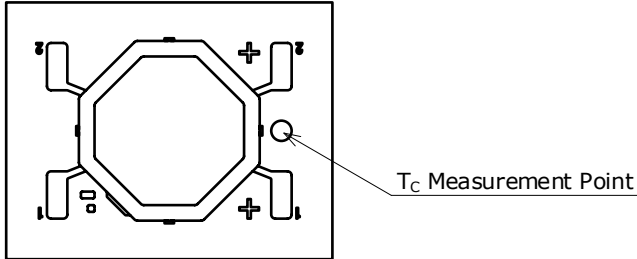

- $R_{\theta JC}$  may change depending on the properties for both the thermal interface material used (e.g. film, gel sheet, paste, or glue) and the heat sink/housing and the surface state of those materials. Ensure that when mounting the LEDs on to the heat sink/housing, the following points are considered:
  - A thermal interface material with a low thermal resistance should be used for the interface between the LED and heat sink/housing.
  - The surface of the heat sink used with the LEDs must not have any small recesses, cavities, or holes; if necessary, the surface must be leveled before mounting the LEDs.
  - If a holder and/or thermal interface material are used, ensure that these materials are properly used and the heat is effectively dissipated.

During use if the thermal interface material deteriorates due to heat and the dimensions change and/or the properties degrade, it may cause these materials not to dissipate the heat properly; this may cause the LED to be damaged. Ensure that reliability verification is performed for the chosen application.

- When measuring the temperatures of LEDs for the thermal management design, a non-contact temperature measuring instrument (e.g. thermal imaging camera) should be used.
- Refer to the relevant application notes for detailed information (e.g. how to handle the COB LEDs, the effect of adhesion strength between the COB and the housing, thermal design considerations, etc.). To access the application notes, go to the Technical Suggestions And Recommendations section of Nichia's website.**

## (7) Cleaning

- Do not clean the LEDs with water, benzine and/or thinner.
- To clean the LEDs, use isopropyl alcohol (IPA). If another solvent is used, it may cause the LED package/resin to be damaged causing issues; ensure that sufficient verification is performed prior to use. Additionally, ensure that the solvent being used does not cause any other issues (e.g. CFC-based solvents are heavily regulated).
- If an LED is contaminated (e.g. dust/dirt), use a cloth soaked with isopropyl alcohol (IPA). Ensure that the cloth is firmly squeezed before wiping the LED.
- Do not clean the LEDs with an ultrasonic cleaner. If cleaning must be done, ensure that sufficient verification is performed by using a finished assembly with LEDs to determine cleaning conditions (e.g. ultrasonic power, LED position on the PCB assembly) that do not cause an issue.

## (8) Eye Safety

- There may be two important international specifications that should be noted for safe use of the LEDs: IEC 62471:2006 Photobiological safety of lamps and lamp systems and IEC 60825-1:2001 (i.e. Edition 1.2) Safety of Laser Products - Part 1: Equipment Classification and Requirements. Ensure that when using the LEDs, there are no issues with the following points:
  - LEDs have been removed from the scope of IEC 60825-1 since IEC 60825-1:2007 (i.e. Edition 2.0) was published. However, depending on the country/region, there are cases where the requirements of the IEC 60825-1:2001 specifications or equivalent must be adhered to.
  - LEDs have been included in the scope of IEC 62471:2006 since the release of the specification in 2006.
  - Most Nichia LEDs will be classified as the Exempt Group or Risk Group 1 according to IEC 62471:2006. However, in the case of high-power LEDs containing blue wavelengths in the emission spectrum, there are LEDs that will be classified as Risk Group 2 depending on the characteristics (e.g. radiation flux, emission spectrum, directivity, etc.)
  - If the LED is used in a manner that produces an increased output or with an optic to collimate the light from the LED, it may cause damage to the human eye.
- If an LED is operated in a manner that emits a flashing light, it may cause health issues (e.g. visual stimuli causing eye discomfort). The system should be designed to ensure that there are no harmful effects on the human body.

## (9) Miscellaneous

- Nichia warrants that the discrete LEDs will meet the requirements/criteria as detailed in the Reliability section within this specification. If the LEDs are used under conditions/environments deviating from or inconsistent with those described in this specification, the resulting damage and/or injuries will not be covered by this warranty.
- Nichia warrants that the discrete LEDs manufactured and/or supplied by Nichia will meet the requirements/criteria as detailed in the Reliability section within this specification; it is the customer's responsibility to perform sufficient verification prior to use to ensure that the lifetime and other quality characteristics required for the intended use are met.
- The applicable warranty period is one year from the date that the LED is delivered. In the case of any incident that appears to be in breach of this warranty, the local Nichia sales representative should be notified to discuss instructions on how to proceed while ensuring that the LED in question is not disassembled or removed from the PCB if it has been attached to the PCB. If a breach of this warranty is proved, Nichia will provide the replacement for the non-conforming LED or an equivalent item at Nichia's discretion. **FOREGOING ARE THE EXCLUSIVE REMEDIES AVAILABLE TO THE CUSTOMER IN RESPECT OF THE BREACH OF THE WARRANTY CONTAINED HEREIN, AND IN NO EVENT SHALL NICHIA BE RESPONSIBLE FOR ANY INDIRECT, INCIDENTAL OR CONSEQUENTIAL LOSSES AND/OR EXPENSES (INCLUDING LOSS OF PROFIT) THAT MAY BE SUFFERED BY THE CUSTOMER ARISING OUT OF A BREACH OF THE WARRANTY.**
- **NICHIA DISCLAIMS ALL OTHER WARRANTIES, EXPRESS OR IMPLIED, INCLUDING THE IMPLIED WARRANTIES OF MERCHANTABILITY AND FITNESS FOR A PARTICULAR PURPOSE.**
- This LED is intended to be used for general lighting, household appliances, electronic devices (e.g. mobile communication devices); it is not designed or manufactured for use in applications that require safety critical functions (e.g. aircraft, automobiles, combustion equipment, life support systems, nuclear reactor control system, safety devices, spacecraft, submarine repeaters, traffic control equipment, trains, vessels, etc.). If the LEDs are planned to be used for these applications, unless otherwise detailed in the specification, Nichia will neither guarantee that the LED is fit for that purpose nor be responsible for any resulting property damage, injuries and/or loss of life/health. This LED does not comply with IATF 16949 and is not intended for automotive applications.
- The customer will not reverse engineer, disassemble or otherwise attempt to extract knowledge/design information from the LED.
- All copyrights and other intellectual property rights in this specification in any form are reserved by Nichia or the right holders who have granted Nichia permission to use the content. Without prior written permission from Nichia, no part of this specification may be reproduced in any form or by any means.
- Both the customer and Nichia will agree on the official specifications for the supplied LEDs before any programs are officially launched. Without this agreement in writing (i.e. Customer Specific Specification), changes to the content of this specification may occur without notice (e.g. changes to the foregoing specifications and appearance, discontinuation of the LEDs, etc.).