

**NICHIA CORPORATION**

**SPECIFICATIONS FOR RED LED**

**PART NO. NSPR336JS**

• RoHS Compliant



## SPECIFICATIONS

### (1) Absolute Maximum Ratings

Item	Symbol	Absolute Maximum Rating	Unit
Forward Current	$I_F$	50	mA
Pulse Forward Current	$I_{FP}$	150	mA
Reverse Voltage	$V_R$	5	V
Power Dissipation	$P_D$	125	mW
Operating Temperature	$T_{opr}$	-30~85	°C
Storage Temperature	$T_{stg}$	-40~100	°C
Junction Temperature	$T_J$	100	°C

\* Absolute Maximum Ratings at  $T_A=25^\circ\text{C}$ .

\*  $I_{FP}$  conditions with pulse width  $\leq 10\text{ms}$  and duty cycle  $\leq 10\%$ .

### (2) Initial Electrical/Optical Characteristics

Item	Symbol	Condition	Typ	Unit
Forward Voltage	$V_F$	$I_F=20\text{mA}$	2.2	V
Reverse Current	$I_R$	$V_R=5\text{V}$	-	$\mu\text{A}$
Luminous Intensity	$I_v$	$I_F=20\text{mA}$	-	cd
Chromaticity Coordinate	x	-	$I_F=20\text{mA}$	0.696
	y		$I_F=20\text{mA}$	0.303

\* Characteristics at  $T_A=25^\circ\text{C}$ .

\* Luminous Intensity value as per CIE 127:2007 standard.

\* Chromaticity Coordinates as per CIE 1931 Chromaticity Chart.

## RANKS

Item	Rank	Min	Max	Unit
Forward Voltage	-	1.8	2.5	V
Reverse Current	-	-	50	μA
Luminous Intensity	W22	3.65	3.98	cd
	W21	3.35	3.65	
	W12	3.07	3.35	
	W11	2.81	3.07	
	V22	2.58	2.81	
	V21	2.37	2.58	

### Color Ranks

	Rank R8aa			
x	0.6649	0.6562	0.6873	0.6971
y	0.3054	0.3144	0.3126	0.3027

	Rank R8ab			
x	0.6718	0.6649	0.6971	0.7049
y	0.2982	0.3054	0.3027	0.2948

\* Ranking at T<sub>A</sub>=25°C.

\* Forward Voltage Tolerance: ±0.05V

\* Luminous Intensity Tolerance: ±10%

\* Chromaticity Coordinate Tolerance: ±0.01

\* LEDs from the above ranks will be shipped. The rank combination ratio per shipment will be decided by Nichia.

CHROMATICITY DIAGRAM

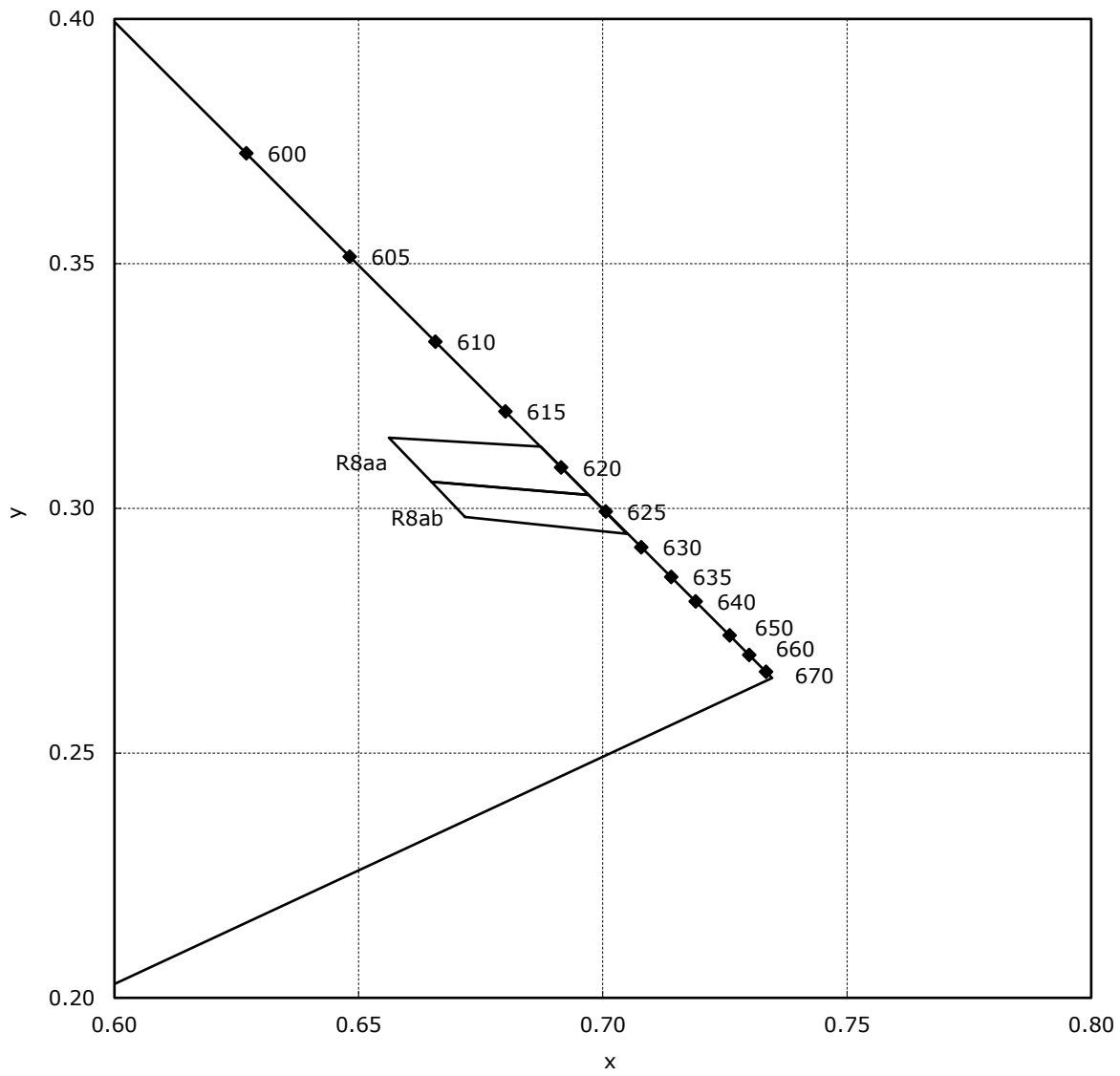

# OUTLINE DIMENSIONS

\* 本製品はRoHS指令に適合しております。  
This product complies with RoHS Directive.

Part No. NSPR336xS  
No. STS-DA7-15235A

\* 括弧で囲まれた寸法は参考値です。  
The dimension(s) in parentheses are for reference purposes.

(単位 Unit: mm, 公差 Tolerance: ±0.2)

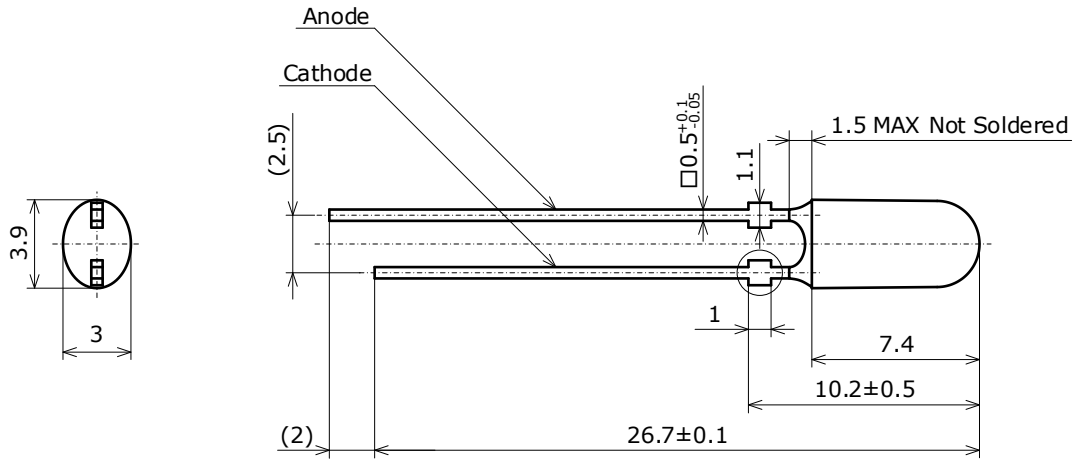

項目 Item	内容 Description
樹脂材質 Resin Materials	エポキシ樹脂 Epoxy Resin
レンズ色 Lens Color	赤色(拡散剤入り) Red(with diffuser)
リードフレーム材質 Lead Frame Materials	鉄+銀メッキ+鉛フリーはんだメッキ Ag-plated and Lead-free Solder-plated Iron
質量 Weight	0.18g(TYP)

ストッパー部詳細図  
Lead Standoff

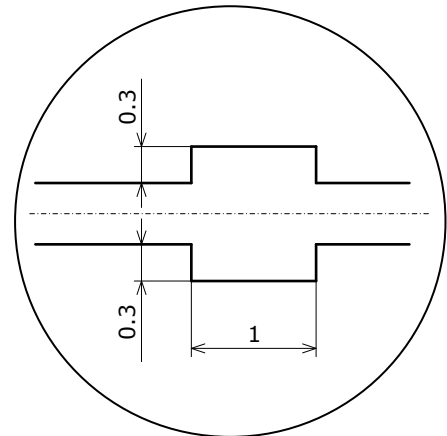

- \* タイバーを切り取った部分は鉄が露出しております。  
またLEDには鋭利な部分があります。特にリード部分は、人体を傷つけることがありますので、取り扱いに際しては十分注意して下さい。  
The tie bar cut-end surface exhibits exposed iron base metal.  
Care must be taken to handle the LEDs, as it may contain sharp parts such as lead, and can cause injury.
- \* レンズ樹脂部の形状は、同じ336シリーズにおいても製品型番毎にそれぞれ異なります。製品外形に関係する部品、治具等設計の際は十分注意して下さい。  
Care must be taken to design LED shape-related parts and tools as the lens shape varies by part number, even among the same 336 series products.
- \* はんだメッキ部に素地の著しい露出はないこととします。  
No noticeable exposure of base metal of the lead with a solder-dipped finish.

## SOLDERING

• Recommended Hand Soldering Condition

Temperature	350°C Max
Soldering Time	3sec Max
Position	No closer than 2mm from the base of the lens.

• Recommended Dip Soldering Condition

Pre-heat	120°C Max
Pre-heat Time	60sec Max
Solder Bath Temperature	260°C Max
Dipping Time	10sec Max
Dipping Position	No closer than 2mm from the base of the lens.

- \* Solder the LED no closer than 2mm from the bottom of the lens. Soldering beyond the bottom of the lead frame standoff/stopper is recommended.
- \* Dip soldering/hand soldering must not be performed more than once.
- \* When cooling the LEDs from the peak temperature a gradual cooling slope is recommended; do not cool the LEDs rapidly.
- \* When soldering, do not apply stress to the lead frame while the LED is hot.
- \* When using a pick and place machine, choose an appropriate nozzle for this product.
- \* After soldering, do not correct the LED position.
- \* After soldering, ensure that the LED is not exposed to shocks/vibrations before it cools down to room temperature.
- \* If the LEDs are soldered to a PCB in a manner that leaves no gap between the LED and PCB (i.e. flush mount), it may cause damage to the lens when the PCB bows/warps or the lead frame is clinched/cut; this will not be guaranteed. If it must be done, it is the customer's responsibility to perform sufficient verification to ensure that there are no issues (e.g. internal disconnection, damage to resin, etc.). For cases where double-sided PCBs are soldered in this manner, the resulting heat will have a direct effect on the lens; this must not be performed on the LEDs.
- \* If the LED is clamped during dip soldering to prevent soldering failures (e.g. position shift), ensure that the mechanical stress on the LED is minimized.
- \* Ensure that the cutting of the lead frames is performed at room temperature. If it is done while the LED is hot, it may cause issues (e.g. damage to the LED).
- \* Consider factors (e.g. dip soldering temperature, hand soldering temperature, etc.) when choosing the solder.
- \* When flux is used, it should be a halogen free flux. Ensure that the manufacturing process is not designed in a manner where the flux will come in contact with the LEDs.

PACKAGING - BULK

Part No. Nxxxxxxx  
No. STS-DA7-0001H

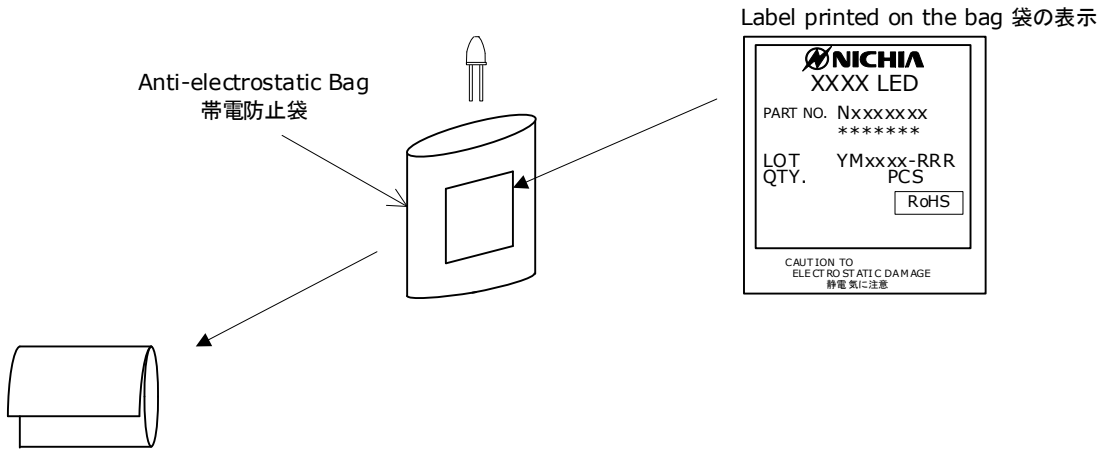

Anti-electrostatic bags are packed in cardboard boxes with corrugated partitions.  
帯電防止袋を並べて入れ、ダンボールで仕切ります。

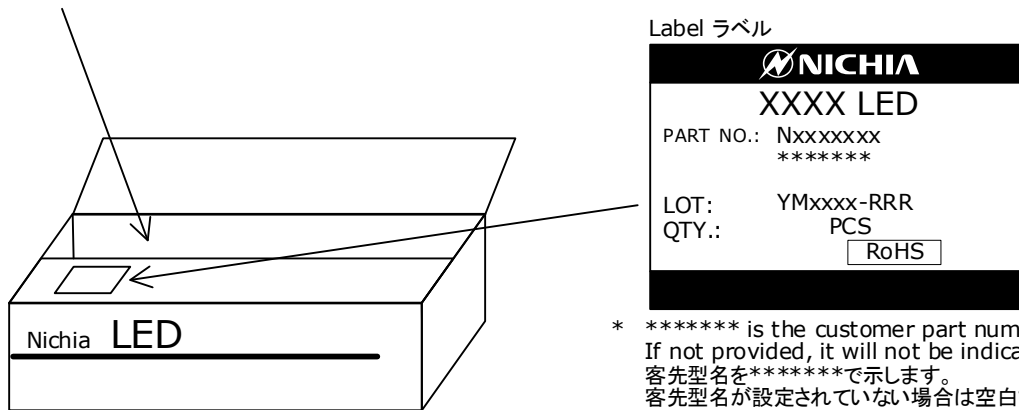

- \* \*\*\*\*\* is the customer part number. If not provided, it will not be indicated on the label.  
客先型名を\*\*\*\*\*で示します。  
客先型名が設定されていない場合は空白です。
- \* For details, see "LOT NUMBERING CODE" in this document.  
ロット表記方法についてはロット番号の項を参照して下さい。

- \* Products are packed in an anti-electrostatic bag. They are shipped in cardboard boxes to protect them from external forces during transportation.  
本製品は帯電防止袋に入れたのち、輸送の衝撃から保護するためダンボールで梱包します。
- \* Do not drop or expose the box to external forces as it may damage the products.  
取り扱いに際して、落下させたり、強い衝撃を与えたりしますと、製品を損傷させる原因になりますので注意して下さい。
- \* Do not expose to water. The box is not water-resistant.  
ダンボールには防水加工がされておきませんので、梱包箱が水に濡れないよう注意して下さい。
- \* Using the original package material or equivalent in transit is recommended.  
輸送、運搬に際して弊社よりの梱包状態あるいは同等の梱包を行って下さい。

# LOT NUMBERING CODE

Lot Number is presented by using the following alphanumeric code.

YMxxxx - RRR

Y - Year

Year	Y
2023	N
2024	O
2025	P
2026	Q
2027	R
2028	S

M - Month

Month	M	Month	M
1	1	7	7
2	2	8	8
3	3	9	9
4	4	10	A
5	5	11	B
6	6	12	C

xxxx-Nichia's Product Number

RRR-Ranking by Color Coordinates, Ranking by Luminous Intensity



# DERATING CHARACTERISTICS

NSPR336xS  
管理番号 No. STS-DA7-1400A

**周囲温度-許容順電流特性**  
**Ambient Temperature vs**  
**Allowable Forward Current**

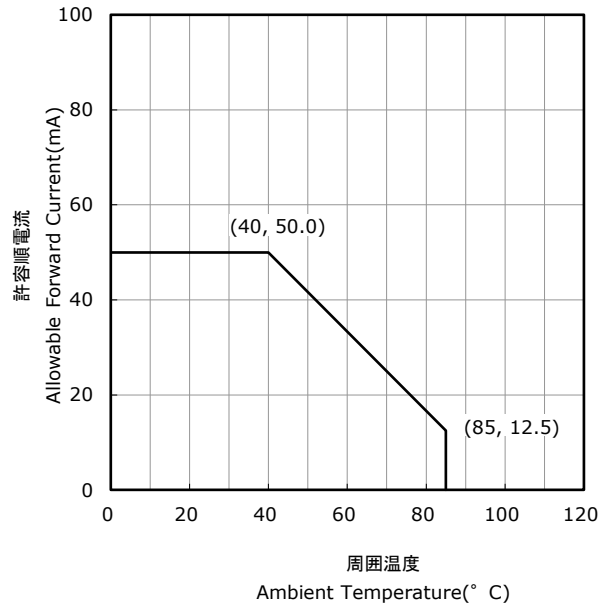

**デューティー比-許容順電流特性**  
**Duty Ratio vs**  
**Allowable Forward Current**

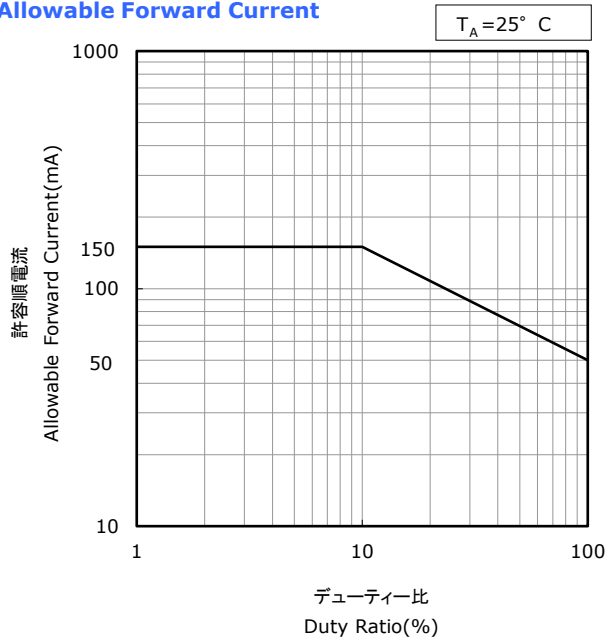

# OPTICAL CHARACTERISTICS

\* All characteristics shown are for reference only and are not guaranteed.  
 本特性は参考です。

Part No. NSPR336JS  
 No. STS-DA7-20518

## Spectrum 発光スペクトル

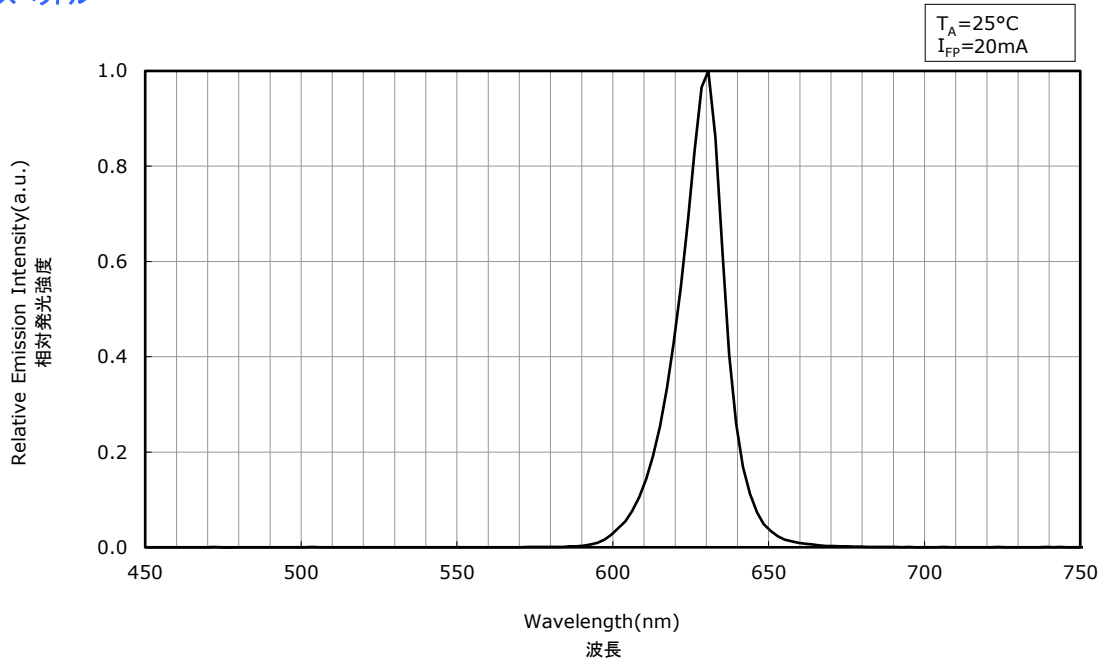

## Directivity 指向特性

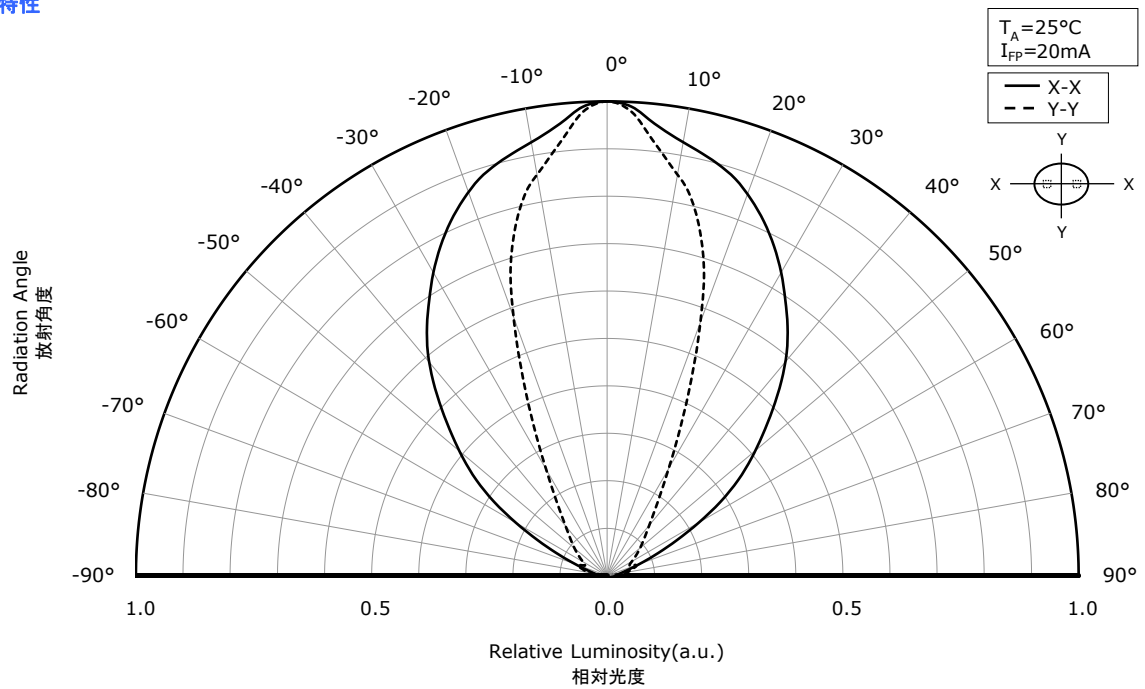

# FORWARD CURRENT CHARACTERISTICS / TEMPERATURE CHARACTERISTICS

\* All characteristics shown are for reference only and are not guaranteed.  
 本特性は参考です。

Part No. NSPR336xS  
 No. STS-DA7-20499

**Forward Voltage vs Forward Current**  
 順電圧-順電流特性

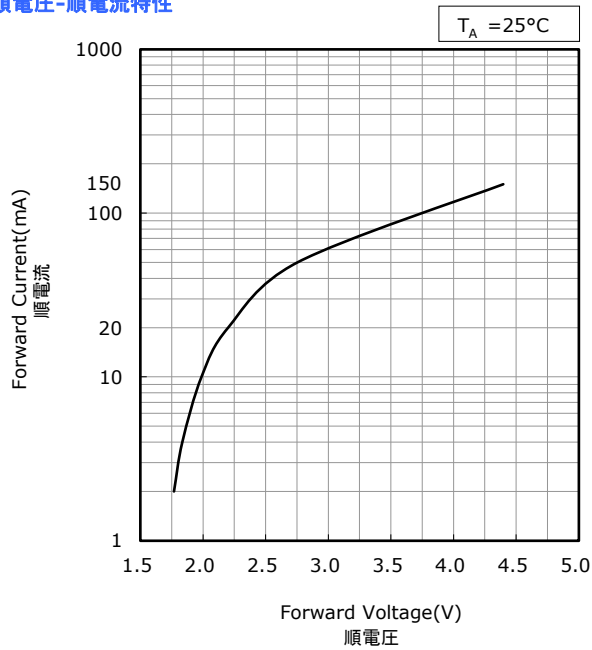

**Ambient Temperature vs Forward Voltage**  
 周囲温度-順電圧特性

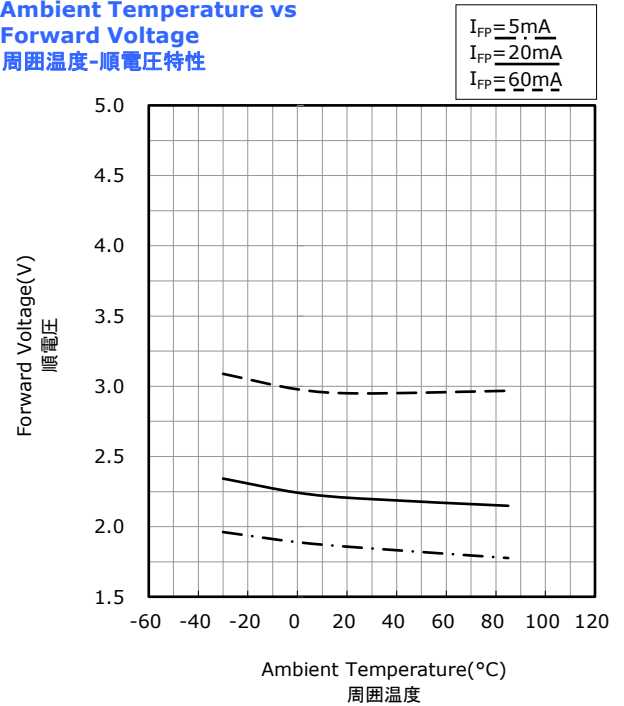

**Forward Current vs Relative Luminosity**  
 順電流-相対光度特性

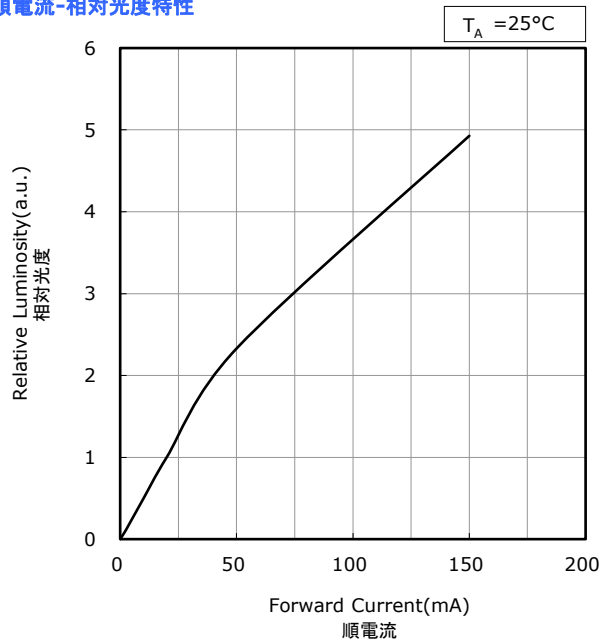

**Ambient Temperature vs Relative Luminosity**  
 周囲温度-相対光度特性

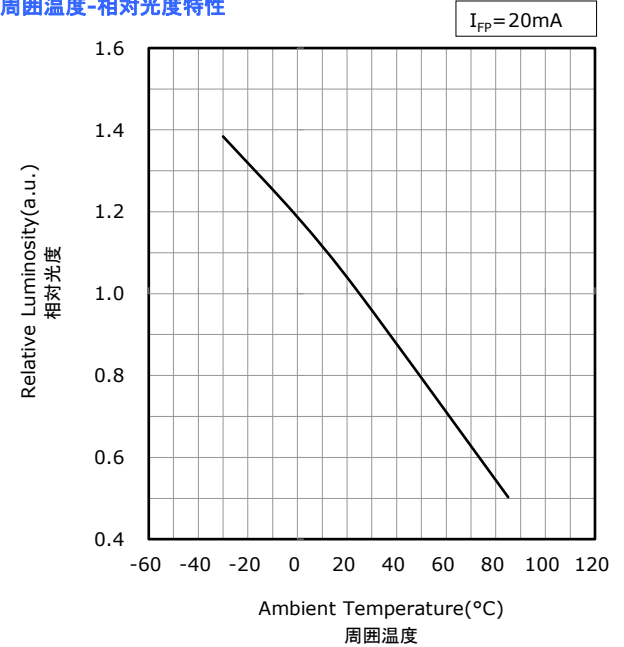

# FORWARD CURRENT CHARACTERISTICS / TEMPERATURE CHARACTERISTICS

\* All characteristics shown are for reference only and are not guaranteed.  
 本特性は参考です。

Part No. NSPR336xS  
 No. STS-DA7-20500

**Forward Current vs Chromaticity Coordinate**  
 順電流-色度 特性

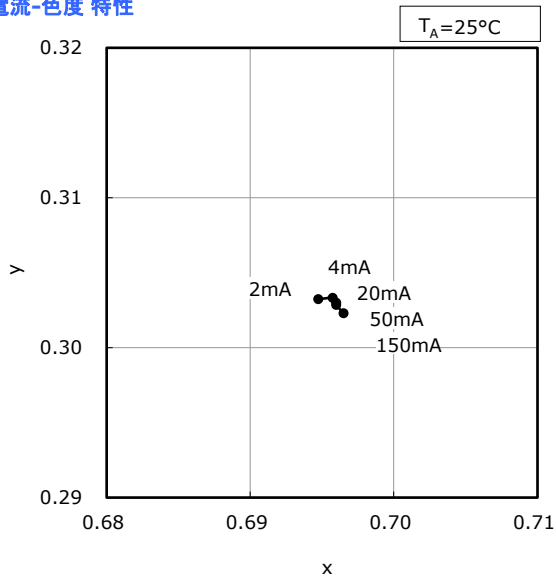

**Ambient Temperature vs Chromaticity Coordinate**  
 周囲温度-色度 特性

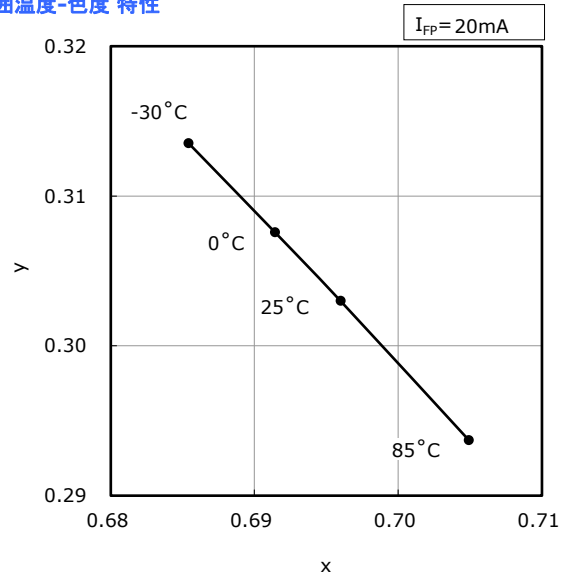

**Forward Current vs Dominant Wavelength**  
 順電流-主波長特性

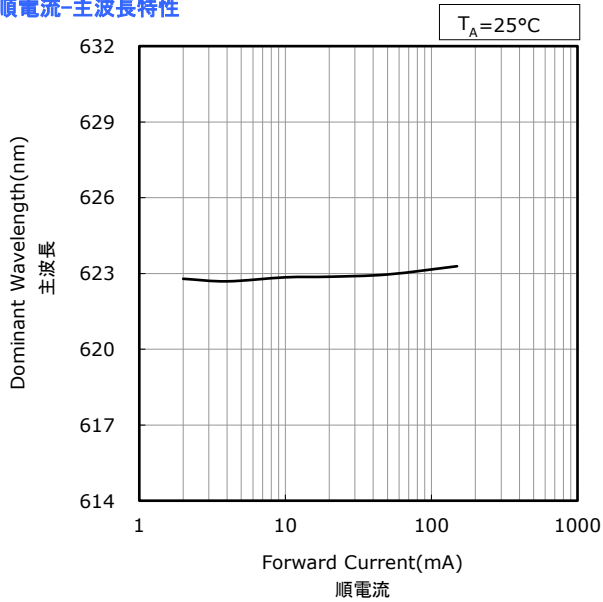

**Ambient Temperature vs Dominant Wavelength**  
 周囲温度-主波長特性

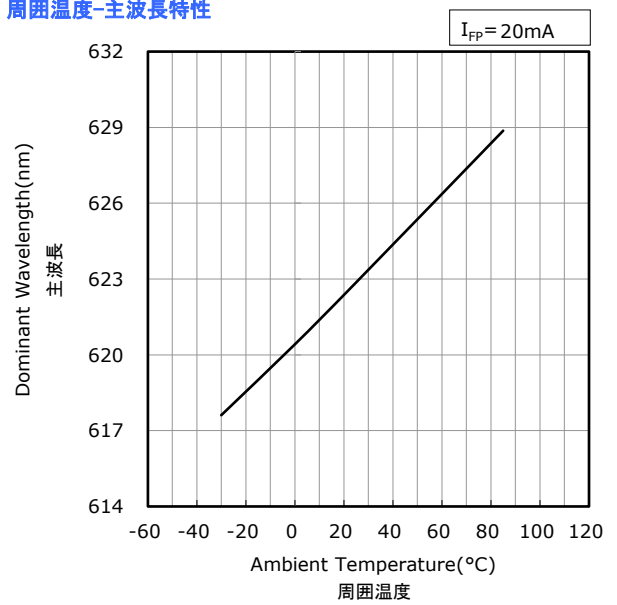

## RELIABILITY

### (1) Tests and Results

Test	Reference Standard	Test Conditions	Test Duration	Failure Criteria #	Units Failed/Tested
Resistance to Soldering Heat	JEITA ED-4701 300 302	$T_{\text{sid}}=260\pm 5^{\circ}\text{C}$ , 10sec, 1dip, 2mm from the base of the lens		#1	0/22
Thermal Shock(Air to Air)		$-40^{\circ}\text{C}$ to $100^{\circ}\text{C}$ , 15min dwell	100cycles	#1	0/22
Moisture Resistance (Cyclic)	JEITA ED-4701 200 203	$25^{\circ}\text{C}\sim 65^{\circ}\text{C}\sim -10^{\circ}\text{C}$ , 90%RH, 24hr per cycle	10cycles	#1	0/22
Terminal Bend Strength	JEITA ED-4701 400 401	5N, $0^{\circ}\sim 90^{\circ}\sim 0^{\circ}$ bend, 2bending cycles		#1	0/22
Terminal Pull Strength	JEITA ED-4701 400 401	10N, $10\pm 1\text{sec}$		#1	0/22
High Temperature Storage	JEITA ED-4701 200 201	$T_{\text{A}}=100^{\circ}\text{C}$	1000hours	#1	0/22
Temperature Humidity Storage	JEITA ED-4701 100 103	$T_{\text{A}}=60^{\circ}\text{C}$ , RH=90%	1000hours	#1	0/22
Low Temperature Storage	JEITA ED-4701 200 202	$T_{\text{A}}=-40^{\circ}\text{C}$	1000hours	#1	0/22
Room Temperature Operating Life		$T_{\text{A}}=25^{\circ}\text{C}$ , $I_{\text{F}}=50\text{mA}$	1000hours	#1	0/22
Temperature Humidity Operating Life		$60^{\circ}\text{C}$ , RH=90%, $I_{\text{F}}=20\text{mA}$	500hours	#1	0/22
Low Temperature Operating Life		$T_{\text{A}}=-30^{\circ}\text{C}$ , $I_{\text{F}}=20\text{mA}$	1000hours	#1	0/22

NOTES:

Measurements are performed after allowing the LEDs to return to room temperature.

### (2) Failure Criteria

Criteria #	Items	Conditions	Failure Criteria
#1	Forward Voltage( $V_{\text{F}}$ )	$I_{\text{F}}=20\text{mA}$	$> \text{U.S.L.} \times 1.1$
	Luminous Intensity( $I_{\text{V}}$ )	$I_{\text{F}}=20\text{mA}$	$< \text{L.S.L.} \times 0.7$
	Reverse Current( $I_{\text{R}}$ )	$V_{\text{R}}=5\text{V}$	$> \text{U.S.L.} \times 2.0$

U.S.L. : Upper Specification Limit    L.S.L. : Lower Specification Limit

## CAUTIONS

### (1) Lead Forming

- The lead frame should be bent at least 3mm from the bottom of the lens. Do not use the bottom of the lens as a fulcrum for bending.
- Lead frame forming (i.e. shaping/trimming the lead frame) should be done before soldering the LED; if it is done after soldering, Nichia will not guarantee its reliability.
- When shaping/trimming the lead frame, ensure that the resulting stress is not applied to the bottom of the lens. This may damage the characteristics of the LED.
- If the LEDs are attached to a PCB or any other substrate (e.g. plastic plate), ensure that the hole on the substrate matches with the lead frame dimensions (e.g. pitch). Otherwise, it may cause the lens to deform causing reliability issues (e.g. the LED to become dimmer or not to illuminate [i.e. catastrophic failure]).

### (2) Storage

- Before opening the anti-electrostatic bag, ensure that LEDs are stored at <30°C and 70% RH and used within three months. To store these LEDs after this period, use a hermetically-sealed container filled with nitrogen and place silica gel desiccants in this container with the LEDs; the LEDs must not be stored for longer than one year from the date that the LED is delivered.
- To avoid condensation, the products must not be stored in the areas where temperature and humidity fluctuate greatly.
- The parts/materials (e.g. housing, gasket/seal, secondary lens, lens cover, thermal grease, etc.) used with the LED in the same assembly/system may release corrosive gases containing sulfur, halogens, etc. A light-up test, sufficient verifications, etc. must be performed at the finished product level (i.e. automotive headlamp, luminaire, etc.) prior to use taking into consideration the conditions/environments in which the finished product will actually be used to ensure that the expected performance for the finished product is maintained. See below for the detailed information.

Issues that may be caused by corrosive gases containing sulfur, halogens, etc.:

This LED has plated parts. If the LED is exposed to corrosive gases containing sulfur, halogens, etc., it may cause the plated surface to tarnish. If the gases penetrate the LED (e.g. emitting surface, package material, etc.), it may cause the surface of the plated parts inside the package to tarnish. In addition, it has been confirmed that if a silicone resin is used in the LED, the gases may accelerate degradation of the silicone resin. As a result, the optical characteristics may be adversely affected (i.e. significant reduction in the brightness, significant color shift, etc.); in the worst case, the circuit could become open causing a catastrophic failure (i.e. the LED not to illuminate). When determining the storage environment for the LED and/or selecting parts/materials that will be used with the LED in the finished product, it must be ensured prior to use that corrosive gases containing sulfur, halogens, etc. are not generated.

- Do not store the LEDs in a dusty environment.
- Do not expose the LEDs to direct sunlight and/or an environment over a long period of time where the temperature is higher than normal room temperature.

### (3) Directions for Use

- The circuit must be designed to ensure that the Absolute Maximum Ratings are not exceeded for each LED. The LEDs should be operated at a constant current per LED. In the case of operating at a constant voltage, Circuit B is recommended. If Circuit A is used, it may cause the currents flowing through the LEDs to vary due to the variation in the forward voltage characteristics of the LEDs on the circuit.

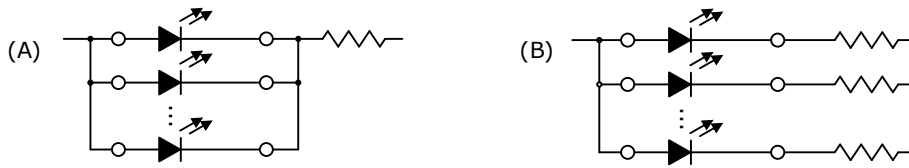

- This LED is designed to be operated at a forward current. Ensure that no voltage is applied to the LED in the forward/reverse direction while the LED is off. If the LEDs are used in an environment where reverse voltages are applied to the LED continuously, it may cause electrochemical migration to occur causing the LED to be damaged. When not in use for a long period of time, the system's power should be turned off to ensure that there are no issues/damage.
- To stabilize the LED characteristics while in use, Nichia recommends that the LEDs are operated at currents  $\geq 10\%$  of the sorting current.
- If LEDs are arranged into rows and columns in a grid circuit (i.e. LED matrix circuit) and operated, ensure that when using a pulsed mode to operate the LEDs in a matrix circuit, the reverse voltage for any of the LEDs does not exceed the Absolute Maximum Rating while the LED is off.
- Ensure that transient excessive voltages (e.g. lightning surge) are not applied to the LEDs.
- To detect manufacturing/assembly defects, the LEDs should be operated for a certain period of time after soldering to a PCB. Ensure that excessive current/voltage is not applied to the LEDs and/or water condensation does not occur during the operation process.
- This LED is designed for indoor/outdoor displays to be used in normal environments. To use the LEDs in the following environments, the display should be designed to protect LEDs from resulting damage/contamination (e.g. dust/debris, water/moisture and gas that may adversely affect the LEDs):
  - where water vapor is abundant
  - where water condensation is likely to occur
  - where water is likely to splash onto the LEDs
  - where frost is likely to form on the surface of the LEDs (e.g. freezer, ice skating rink, etc.)
  - where dust, dirt, debris, loose metallic materials and/or gases are present that will adversely affect the LEDs
- If the LEDs are used for outdoor displays, ensure that the lead frame is properly covered with a silicone resin and not exposed. The silicone resin should be applied to the lead frame until it reaches to the lens to reduce the amount of moisture that the LED lens absorbs, as long as it does not have an effect on the optical characteristics. Choose a silicone resin sufficient to protect the LED from harsh environments (e.g. water/salt damage, and high humidity).
- Nichia recommends using a shade (e.g. louver) to block direct sunlight to the LED. This may be able to slow the luminous degradation of the LEDs resulting in a longer operating-life for the display.
- The lifetime may be shortened in areas where:
  - hydrogen sulfide (i.e. a sulfide-based gas) is present (e.g. hot springs and volcanic areas)
  - salt is abundant (e.g. coastal areas)
- When power is applied for the first time after installation, the display should not be powered at 100% wattage since the LEDs may have absorbed moisture. Before normal use of this display, operate the display at approximately 20% wattage for an initial time period.
- If display units from multiple different displays are used to assemble a large display for a specific rental period, ensure that when choosing the display units there are no issues with variation in color/brightness at the display level.
- If the display units are loaded onto and/or transported by ship, the damp environment on the vessel will cause condensation. Ensure that when packaging, the LEDs/display are protected from water/moisture.
- If a display that has been, or is being, used is relocated, it is possible that degradation of the LED has occurred; ensure that:
  - while in transit, the LEDs are fully protected from any damage (e.g. vibration, shock, water/moisture, etc.),
  - when reinstalling, the installation environment/method are correct and comply with the installation instructions,
  - after reinstalling, the LEDs/display are used according to the installation instructions.

#### (4) Handling Precautions

- Do not handle the LEDs with bare hands:
  - this may contaminate the LED surface and have an effect on the optical characteristics,
  - this may cause the LED to deform and/or the wire to break causing a catastrophic failure (i.e. the LED not to illuminate),
  - the lead frame may cause injuries when the LED is handled with bare hands.
- Dropping may cause damage to the LED (e.g. deformation).
- Do not stack assembled PCBs together. Otherwise, it may cause damage to the lens (e.g. cut, scratch, chip, crack, delamination and deformation) and the wire to break causing a catastrophic failure (i.e. the LED not to illuminate).

#### (5) Design Consideration

- If the LEDs are soldered to a PCB and the PCB assembly is bent (e.g. PCB depaneling process), it may cause the LED package to break. The PCB layout should be designed to minimize the mechanical stress on the LEDs when the PCB assembly is bent/warped.
- The amount of mechanical stress exerted on the LED from depaneling may vary depending on the LED position/orientation on the PCB assembly (e.g. especially in areas near V-groove scores). The PCB layout should be designed to minimize the mechanical stress on the LEDs when the PCB is separated into individual PCB assemblies.
- To separate a PCB populated with the LEDs, use a specially designed tool. Do not break the PCB by hand.
- The parts/materials (e.g. housing, gasket/seal, secondary lens, lens cover, thermal grease, etc.) used with the LED in the same assembly/system may release corrosive gases containing sulfur, halogens, etc., and/or volatile organic compounds (VOCs). A light-up test, sufficient verifications, etc. must be performed at the finished product level (i.e. automotive headlamp, luminaire, etc.) prior to use taking into consideration the conditions/environments in which the finished product will actually be used to ensure that the expected performance for the finished product is maintained. See below for the detailed information.

Issues that may be caused by corrosive gases containing sulfur, halogens, etc.:

This LED has plated parts. If the LED is exposed to corrosive gases containing sulfur, halogens, etc., it may cause the plated surface to tarnish. If the gases penetrate the LED (e.g. emitting surface, package material, etc.), it may cause the surface of the plated parts inside the package to tarnish. In addition, it has been confirmed that if a silicone resin is used in the LED, the gases may accelerate degradation of the silicone resin. As a result, the optical characteristics may be adversely affected (i.e. significant reduction in the brightness, significant color shift, etc.); in the worst case, the circuit could become open causing a catastrophic failure (i.e. the LED not to illuminate). When determining the storage environment for the LED and/or selecting parts/materials that will be used with the LED in the finished product, it must be ensured prior to use that corrosive gases containing sulfur, halogens, etc. are not generated.

Issues that may be caused by VOCs:

If VOCs that have been released from the parts/materials and/or organic additives used with the LED in the finished product penetrate into the LED and remain inside the LED, the VOCs can discolor after being exposed to heat and/or photon energy. This may cause the optical characteristics to be adversely affected (i.e. significant reduction in the brightness, significant color shift, etc.). This adverse effect may be improved by ventilating the environment (i.e. the LED is not used in a hermetically sealed environment) to prevent the VOCs from remaining inside the LED. When selecting parts/materials that will be used with the LED in the finished product, it must be ensured prior to use that there are no issues with the substances found in those parts/materials and/or that the expected performance for the finished product is maintained by performing a light-up test, sufficient verifications etc. taking into consideration the conditions/environments in which the finished product will actually be used.

#### (6) Thermal Management

- The Absolute Maximum Junction Temperature ( $T_J$ ) must not be exceeded under any circumstances. The increase in the temperature of an LED while in operation may vary depending on the PCB thermal resistance and the density of LEDs on the PCB assembly. Ensure that when using the LEDs for the chosen application, heat is not concentrated in an area and properly managed in the system/assembly.
- The operating current should be determined by considering the temperature conditions surrounding the LED (i.e.  $T_A$ ). Ensure that when operating the LED, proper measures are taken to dissipate the heat.



## (7) Cleaning

- Do not clean the LEDs with water, benzine and/or thinner.
- To clean the LEDs, use isopropyl alcohol (IPA). If another solvent is used, it may cause the LED package/resin to be damaged causing issues; ensure that sufficient verification is performed prior to use. Additionally, ensure that the solvent being used does not cause any other issues (e.g. CFC-based solvents are heavily regulated).
- If an LED is contaminated (e.g. dust/dirt), use a cloth soaked with isopropyl alcohol (IPA). Ensure that the cloth is firmly squeezed before wiping the LED.
- Do not clean the LEDs with an ultrasonic cleaner. If cleaning must be done, ensure that sufficient verification is performed by using a finished assembly with LEDs to determine cleaning conditions (e.g. ultrasonic power, LED position on the PCB assembly) that do not cause an issue.

## (8) Eye Safety

- There may be two important international specifications that should be noted for safe use of the LEDs: IEC 62471:2006 Photobiological safety of lamps and lamp systems and IEC 60825-1:2001 (i.e. Edition 1.2) Safety of Laser Products - Part 1: Equipment Classification and Requirements. Ensure that when using the LEDs, there are no issues with the following points:
  - LEDs have been removed from the scope of IEC 60825-1 since IEC 60825-1:2007 (i.e. Edition 2.0) was published. However, depending on the country/region, there are cases where the requirements of the IEC 60825-1:2001 specifications or equivalent must be adhered to.
  - LEDs have been included in the scope of IEC 62471:2006 since the release of the specification in 2006.
  - Most Nichia LEDs will be classified as the Exempt Group or Risk Group 1 according to IEC 62471:2006. However, in the case of high-power LEDs containing blue wavelengths in the emission spectrum, there are LEDs that will be classified as Risk Group 2 depending on the characteristics (e.g. radiation flux, emission spectrum, directivity, etc.)
  - If the LED is used in a manner that produces an increased output or with an optic to collimate the light from the LED, it may cause damage to the human eye.
- If an LED is operated in a manner that emits a flashing light, it may cause health issues (e.g. visual stimuli causing eye discomfort). The system should be designed to ensure that there are no harmful effects on the human body.

## (9) Miscellaneous

- Nichia warrants that the discrete LEDs will meet the requirements/criteria as detailed in the Reliability section within this specification. If the LEDs are used under conditions/environments deviating from or inconsistent with those described in this specification, the resulting damage and/or injuries will not be covered by this warranty.
- Nichia warrants that the discrete LEDs manufactured and/or supplied by Nichia will meet the requirements/criteria as detailed in the Reliability section within this specification; it is the customer's responsibility to perform sufficient verification prior to use to ensure that the lifetime and other quality characteristics required for the intended use are met.
- The applicable warranty period is one year from the date that the LED is delivered. In the case of any incident that appears to be in breach of this warranty, the local Nichia sales representative should be notified to discuss instructions on how to proceed while ensuring that the LED in question is not disassembled or removed from the PCB if it has been attached to the PCB. If a breach of this warranty is proved, Nichia will provide the replacement for the non-conforming LED or an equivalent item at Nichia's discretion. FOREGOING ARE THE EXCLUSIVE REMEDIES AVAILABLE TO THE CUSTOMER IN RESPECT OF THE BREACH OF THE WARRANTY CONTAINED HEREIN, AND IN NO EVENT SHALL NICHIA BE RESPONSIBLE FOR ANY INDIRECT, INCIDENTAL OR CONSEQUENTIAL LOSSES AND/OR EXPENSES (INCLUDING LOSS OF PROFIT) THAT MAY BE SUFFERED BY THE CUSTOMER ARISING OUT OF A BREACH OF THE WARRANTY.
- NICHIA DISCLAIMS ALL OTHER WARRANTIES, EXPRESS OR IMPLIED, INCLUDING THE IMPLIED WARRANTIES OF MERCHANTABILITY AND FITNESS FOR A PARTICULAR PURPOSE.
- This LED is intended to be used for general lighting, household appliances, electronic devices (e.g. mobile communication devices); it is not designed or manufactured for use in applications that require safety critical functions (e.g. aircraft, automobiles, combustion equipment, life support systems, nuclear reactor control system, safety devices, spacecraft, submarine repeaters, traffic control equipment, trains, vessels, etc.). If the LEDs are planned to be used for these applications, unless otherwise detailed in the specification, Nichia will neither guarantee that the LED is fit for that purpose nor be responsible for any resulting property damage, injuries and/or loss of life/health. This LED does not comply with IATF 16949 and is not intended for automotive applications.
- The customer will not reverse engineer, disassemble or otherwise attempt to extract knowledge/design information from the LED.
- All copyrights and other intellectual property rights in this specification in any form are reserved by Nichia or the right holders who have granted Nichia permission to use the content. Without prior written permission from Nichia, no part of this specification may be reproduced in any form or by any means.
- Both the customer and Nichia will agree on the official specifications for the supplied LEDs before any programs are officially launched. Without this agreement in writing (i.e. Customer Specific Specification), changes to the content of this specification may occur without notice (e.g. changes to the foregoing specifications and appearance, discontinuation of the LEDs, etc.).