

NICHIA CORPORATION

SPECIFICATIONS FOR WHITE LED

PART NO. NJSW157KT-HG

- Pb-free Reflow Soldering Application
- ESD Withstand Voltage (HBM) Class 3B
- RoHS Compliant

SPECIFICATIONS

(1) Absolute Maximum Ratings

Item	Symbol	Absolute Maximum Rating	Unit
Forward Current	I_F	200	mA
Pulse Forward Current	I_{FP}	400	mA
ESD Withstand Voltage (HBM)	V_{ESD}	8	kV
Allowable Reverse Current	I_R	85	mA
Power Dissipation	P_D	619	mW
Operating Temperature	T_{opr}	-40~100	°C
Storage Temperature	T_{stg}	-40~100	°C
Junction Temperature	T_J	125	°C

* Absolute Maximum Ratings at $T_S=25^\circ\text{C}$.

* I_{FP} conditions with pulse width $\leq 10\text{ms}$ and duty cycle $\leq 10\%$.

* HBM ESD Component Classification Level of the LEDs: Class 3B

For more details, see ANSI/ESDA/JEDEC JS-001.

(2) Initial Electrical/Optical Characteristics

Item	Symbol	Condition	Typ	Max	Unit	
Forward Voltage	V_F	$I_F=120\text{mA}$	2.93	-	V	
Luminous Flux	Φ_v	$I_F=120\text{mA}$	49.5	-	lm	
Luminous Intensity	I_v	$I_F=120\text{mA}$	16.2	-	cd	
Chromaticity Coordinate	x	-	$I_F=120\text{mA}$	0.277	-	-
	y		$I_F=120\text{mA}$	0.260	-	
Thermal Resistance	$R_{\theta JS}$	-	19	26	°C/W	

* Characteristics at $T_S=25^\circ\text{C}$.

* Luminous Flux value as per CIE 127:2007 standard.

* Chromaticity Coordinates as per CIE 1931 Chromaticity Chart.

* $R_{\theta JS}$ is the thermal resistance from the junction to the T_S measurement point.

* This LED uses a unique red phosphor that has a slow response time; when compared with the blue die and green phosphor in the LED, the red will fluoresce with a delayed pulse of about 10msec and have an afterglow for about 10msec after the blue die dims. If the LEDs are operated with a pulse current, ensure that there are no issues.

RANKS

Item	Rank	Min	Max	Unit
Forward Voltage	-	2.7	3.1	V
Luminous Flux	P14d2b	58.10	63.25	lm
	P14d2a	53.30	58.10	
	P13d2b	48.80	53.30	
	P13d2a	44.80	48.80	
	P12d2b	41.00	44.80	

Color Ranks

	Rank Btf45da			
x	0.2835	0.2850	0.2905	0.2890
y	0.3000	0.3050	0.3050	0.3000

	Rank Btf45db			
x	0.2835	0.2850	0.2905	0.2890
y	0.3000	0.3050	0.3050	0.3000

	Rank Btf45dc			
x	0.2835	0.2850	0.2905	0.2890
y	0.3000	0.3050	0.3050	0.3000

	Rank Btf45dd			
x	0.2835	0.2850	0.2905	0.2890
y	0.3000	0.3050	0.3050	0.3000

	Rank Btf46da			
x	0.2820	0.2835	0.2890	0.2875
y	0.2950	0.3000	0.3000	0.2950

	Rank Btf46db			
x	0.2820	0.2835	0.2890	0.2875
y	0.2950	0.3000	0.3000	0.2950

	Rank Btf46dc			
x	0.2820	0.2835	0.2890	0.2875
y	0.2950	0.3000	0.3000	0.2950

	Rank Btf46dd			
x	0.2820	0.2835	0.2890	0.2875
y	0.2950	0.3000	0.3000	0.2950

	Rank Btf47da			
x	0.2805	0.2820	0.2875	0.2860
y	0.2900	0.2950	0.2950	0.2900

	Rank Btf47db			
x	0.2805	0.2820	0.2875	0.2860
y	0.2900	0.2950	0.2950	0.2900

	Rank Btf47dc			
x	0.2805	0.2820	0.2875	0.2860
y	0.2900	0.2950	0.2950	0.2900

	Rank Btf47dd			
x	0.2805	0.2820	0.2875	0.2860
y	0.2900	0.2950	0.2950	0.2900

	Rank Btf48da			
x	0.2790	0.2805	0.2860	0.2845
y	0.2850	0.2900	0.2900	0.2850

	Rank Btf48db			
x	0.2790	0.2805	0.2860	0.2845
y	0.2850	0.2900	0.2900	0.2850

	Rank Btf48dc			
x	0.2790	0.2805	0.2860	0.2845
y	0.2850	0.2900	0.2900	0.2850

	Rank Btf48dd			
x	0.2790	0.2805	0.2860	0.2845
y	0.2850	0.2900	0.2900	0.2850

	Rank Btf49da			
x	0.2775	0.2790	0.2845	0.2830
y	0.2800	0.2850	0.2850	0.2800

	Rank Btf49db			
x	0.2775	0.2790	0.2845	0.2830
y	0.2800	0.2850	0.2850	0.2800

	Rank Btf49dc			
x	0.2775	0.2790	0.2845	0.2830
y	0.2800	0.2850	0.2850	0.2800

	Rank Btf49dd			
x	0.2775	0.2790	0.2845	0.2830
y	0.2800	0.2850	0.2850	0.2800

Rank Btf50da				
x	0.2760	0.2775	0.2830	0.2815
y	0.2750	0.2800	0.2800	0.2750

Rank Btf50db				
x	0.2760	0.2775	0.2830	0.2815
y	0.2750	0.2800	0.2800	0.2750

Rank Btf50dc				
x	0.2760	0.2775	0.2830	0.2815
y	0.2750	0.2800	0.2800	0.2750

Rank Btf50dd				
x	0.2760	0.2775	0.2830	0.2815
y	0.2750	0.2800	0.2800	0.2750

Rank Btf51da				
x	0.2745	0.2760	0.2815	0.2800
y	0.2700	0.2750	0.2750	0.2700

Rank Btf51db				
x	0.2745	0.2760	0.2815	0.2800
y	0.2700	0.2750	0.2750	0.2700

Rank Btf51dc				
x	0.2745	0.2760	0.2815	0.2800
y	0.2700	0.2750	0.2750	0.2700

Rank Btf51dd				
x	0.2745	0.2760	0.2815	0.2800
y	0.2700	0.2750	0.2750	0.2700

Rank Btf52da				
x	0.2730	0.2745	0.2800	0.2785
y	0.2650	0.2700	0.2700	0.2650

Rank Btf52db				
x	0.2730	0.2745	0.2800	0.2785
y	0.2650	0.2700	0.2700	0.2650

Rank Btf52dc				
x	0.2730	0.2745	0.2800	0.2785
y	0.2650	0.2700	0.2700	0.2650

Rank Btf52dd				
x	0.2730	0.2745	0.2800	0.2785
y	0.2650	0.2700	0.2700	0.2650

Rank Btf53da				
x	0.2715	0.2730	0.2785	0.2770
y	0.2600	0.2650	0.2650	0.2600

Rank Btf53db				
x	0.2715	0.2730	0.2785	0.2770
y	0.2600	0.2650	0.2650	0.2600

Rank Btf53dc				
x	0.2715	0.2730	0.2785	0.2770
y	0.2600	0.2650	0.2650	0.2600

Rank Btf53dd				
x	0.2715	0.2730	0.2785	0.2770
y	0.2600	0.2650	0.2650	0.2600

Rank Btf54da				
x	0.2700	0.2715	0.2770	0.2755
y	0.2550	0.2600	0.2600	0.2550

Rank Btf54db				
x	0.2700	0.2715	0.2770	0.2755
y	0.2550	0.2600	0.2600	0.2550

Rank Btf54dc				
x	0.2700	0.2715	0.2770	0.2755
y	0.2550	0.2600	0.2600	0.2550

Rank Btf54dd				
x	0.2700	0.2715	0.2770	0.2755
y	0.2550	0.2600	0.2600	0.2550

Rank Btf55da				
x	0.2685	0.2700	0.2755	0.2740
y	0.2500	0.2550	0.2550	0.2500

Rank Btf55db				
x	0.2685	0.2700	0.2755	0.2740
y	0.2500	0.2550	0.2550	0.2500

Rank Btf55dc				
x	0.2685	0.2700	0.2755	0.2740
y	0.2500	0.2550	0.2550	0.2500

Rank Btf55dd				
x	0.2685	0.2700	0.2755	0.2740
y	0.2500	0.2550	0.2550	0.2500

Rank Btf56da				
x	0.2670	0.2685	0.2740	0.2725
y	0.2450	0.2500	0.2500	0.2450

Rank Btf56db				
x	0.2670	0.2685	0.2740	0.2725
y	0.2450	0.2500	0.2500	0.2450

	Rank Btf56dc			
x	0.2670	0.2685	0.2740	0.2725
y	0.2450	0.2500	0.2500	0.2450

	Rank Btf56dd			
x	0.2670	0.2685	0.2740	0.2725
y	0.2450	0.2500	0.2500	0.2450

	Rank Btf57da			
x	0.2655	0.2670	0.2725	0.2710
y	0.2400	0.2450	0.2450	0.2400

	Rank Btf57db			
x	0.2655	0.2670	0.2725	0.2710
y	0.2400	0.2450	0.2450	0.2400

	Rank Btf57dc			
x	0.2655	0.2670	0.2725	0.2710
y	0.2400	0.2450	0.2450	0.2400

	Rank Btf57dd			
x	0.2655	0.2670	0.2725	0.2710
y	0.2400	0.2450	0.2450	0.2400

	Rank Btf58da			
x	0.2640	0.2655	0.2710	0.2695
y	0.2350	0.2400	0.2400	0.2350

	Rank Btf58db			
x	0.2640	0.2655	0.2710	0.2695
y	0.2350	0.2400	0.2400	0.2350

	Rank Btf58dc			
x	0.2640	0.2655	0.2710	0.2695
y	0.2350	0.2400	0.2400	0.2350

	Rank Btf58dd			
x	0.2640	0.2655	0.2710	0.2695
y	0.2350	0.2400	0.2400	0.2350

	Rank Btf59da			
x	0.2625	0.2640	0.2695	0.2680
y	0.2300	0.2350	0.2350	0.2300

	Rank Btf59db			
x	0.2625	0.2640	0.2695	0.2680
y	0.2300	0.2350	0.2350	0.2300

	Rank Btf59dc			
x	0.2625	0.2640	0.2695	0.2680
y	0.2300	0.2350	0.2350	0.2300

	Rank Btf59dd			
x	0.2625	0.2640	0.2695	0.2680
y	0.2300	0.2350	0.2350	0.2300

	Rank Btf60da			
x	0.2610	0.2625	0.2680	0.2665
y	0.2250	0.2300	0.2300	0.2250

	Rank Btf60db			
x	0.2610	0.2625	0.2680	0.2665
y	0.2250	0.2300	0.2300	0.2250

	Rank Btf60dc			
x	0.2610	0.2625	0.2680	0.2665
y	0.2250	0.2300	0.2300	0.2250

	Rank Btf60dd			
x	0.2610	0.2625	0.2680	0.2665
y	0.2250	0.2300	0.2300	0.2250

	Rank Btf65da			
x	0.2890	0.2905	0.2960	0.2945
y	0.3000	0.3050	0.3050	0.3000

	Rank Btf65db			
x	0.2890	0.2905	0.2960	0.2945
y	0.3000	0.3050	0.3050	0.3000

	Rank Btf65dc			
x	0.2890	0.2905	0.2960	0.2945
y	0.3000	0.3050	0.3050	0.3000

	Rank Btf65dd			
x	0.2890	0.2905	0.2960	0.2945
y	0.3000	0.3050	0.3050	0.3000

	Rank Btf66da			
x	0.2875	0.2890	0.2945	0.2930
y	0.2950	0.3000	0.3000	0.2950

	Rank Btf66db			
x	0.2875	0.2890	0.2945	0.2930
y	0.2950	0.3000	0.3000	0.2950

	Rank Btf66dc			
x	0.2875	0.2890	0.2945	0.2930
y	0.2950	0.3000	0.3000	0.2950

	Rank Btf66dd			
x	0.2875	0.2890	0.2945	0.2930
y	0.2950	0.3000	0.3000	0.2950

Rank Btf67da				
x	0.2860	0.2875	0.2930	0.2915
y	0.2900	0.2950	0.2950	0.2900

Rank Btf67db				
x	0.2860	0.2875	0.2930	0.2915
y	0.2900	0.2950	0.2950	0.2900

Rank Btf67dc				
x	0.2860	0.2875	0.2930	0.2915
y	0.2900	0.2950	0.2950	0.2900

Rank Btf67dd				
x	0.2860	0.2875	0.2930	0.2915
y	0.2900	0.2950	0.2950	0.2900

Rank Btf68da				
x	0.2845	0.2860	0.2915	0.2900
y	0.2850	0.2900	0.2900	0.2850

Rank Btf68db				
x	0.2845	0.2860	0.2915	0.2900
y	0.2850	0.2900	0.2900	0.2850

Rank Btf68dc				
x	0.2845	0.2860	0.2915	0.2900
y	0.2850	0.2900	0.2900	0.2850

Rank Btf68dd				
x	0.2845	0.2860	0.2915	0.2900
y	0.2850	0.2900	0.2900	0.2850

Rank Btf69da				
x	0.2830	0.2845	0.2900	0.2885
y	0.2800	0.2850	0.2850	0.2800

Rank Btf69db				
x	0.2830	0.2845	0.2900	0.2885
y	0.2800	0.2850	0.2850	0.2800

Rank Btf69dc				
x	0.2830	0.2845	0.2900	0.2885
y	0.2800	0.2850	0.2850	0.2800

Rank Btf69dd				
x	0.2830	0.2845	0.2900	0.2885
y	0.2800	0.2850	0.2850	0.2800

Rank Btf70da				
x	0.2815	0.2830	0.2885	0.2870
y	0.2750	0.2800	0.2800	0.2750

Rank Btf70db				
x	0.2815	0.2830	0.2885	0.2870
y	0.2750	0.2800	0.2800	0.2750

Rank Btf70dc				
x	0.2815	0.2830	0.2885	0.2870
y	0.2750	0.2800	0.2800	0.2750

Rank Btf70dd				
x	0.2815	0.2830	0.2885	0.2870
y	0.2750	0.2800	0.2800	0.2750

Rank Btf71da				
x	0.2800	0.2815	0.2870	0.2855
y	0.2700	0.2750	0.2750	0.2700

Rank Btf71db				
x	0.2800	0.2815	0.2870	0.2855
y	0.2700	0.2750	0.2750	0.2700

Rank Btf71dc				
x	0.2800	0.2815	0.2870	0.2855
y	0.2700	0.2750	0.2750	0.2700

Rank Btf71dd				
x	0.2800	0.2815	0.2870	0.2855
y	0.2700	0.2750	0.2750	0.2700

Rank Btf72da				
x	0.2785	0.2800	0.2855	0.2840
y	0.2650	0.2700	0.2700	0.2650

Rank Btf72db				
x	0.2785	0.2800	0.2855	0.2840
y	0.2650	0.2700	0.2700	0.2650

Rank Btf72dc				
x	0.2785	0.2800	0.2855	0.2840
y	0.2650	0.2700	0.2700	0.2650

Rank Btf72dd				
x	0.2785	0.2800	0.2855	0.2840
y	0.2650	0.2700	0.2700	0.2650

Rank Btf73da				
x	0.2770	0.2785	0.2840	0.2825
y	0.2600	0.2650	0.2650	0.2600

Rank Btf73db				
x	0.2770	0.2785	0.2840	0.2825
y	0.2600	0.2650	0.2650	0.2600

	Rank Btf73dc			
x	0.2770	0.2785	0.2840	0.2825
y	0.2600	0.2650	0.2650	0.2600

	Rank Btf73dd			
x	0.2770	0.2785	0.2840	0.2825
y	0.2600	0.2650	0.2650	0.2600

	Rank Btf74da			
x	0.2755	0.2770	0.2825	0.2810
y	0.2550	0.2600	0.2600	0.2550

	Rank Btf74db			
x	0.2755	0.2770	0.2825	0.2810
y	0.2550	0.2600	0.2600	0.2550

	Rank Btf74dc			
x	0.2755	0.2770	0.2825	0.2810
y	0.2550	0.2600	0.2600	0.2550

	Rank Btf74dd			
x	0.2755	0.2770	0.2825	0.2810
y	0.2550	0.2600	0.2600	0.2550

	Rank Btf75da			
x	0.2740	0.2755	0.2810	0.2795
y	0.2500	0.2550	0.2550	0.2500

	Rank Btf75db			
x	0.2740	0.2755	0.2810	0.2795
y	0.2500	0.2550	0.2550	0.2500

	Rank Btf75dc			
x	0.2740	0.2755	0.2810	0.2795
y	0.2500	0.2550	0.2550	0.2500

	Rank Btf75dd			
x	0.2740	0.2755	0.2810	0.2795
y	0.2500	0.2550	0.2550	0.2500

	Rank Btf76da			
x	0.2725	0.2740	0.2795	0.2780
y	0.2450	0.2500	0.2500	0.2450

	Rank Btf76db			
x	0.2725	0.2740	0.2795	0.2780
y	0.2450	0.2500	0.2500	0.2450

	Rank Btf76dc			
x	0.2725	0.2740	0.2795	0.2780
y	0.2450	0.2500	0.2500	0.2450

	Rank Btf76dd			
x	0.2725	0.2740	0.2795	0.2780
y	0.2450	0.2500	0.2500	0.2450

	Rank Btf77da			
x	0.2710	0.2725	0.2780	0.2765
y	0.2400	0.2450	0.2450	0.2400

	Rank Btf77db			
x	0.2710	0.2725	0.2780	0.2765
y	0.2400	0.2450	0.2450	0.2400

	Rank Btf77dc			
x	0.2710	0.2725	0.2780	0.2765
y	0.2400	0.2450	0.2450	0.2400

	Rank Btf77dd			
x	0.2710	0.2725	0.2780	0.2765
y	0.2400	0.2450	0.2450	0.2400

	Rank Btf78da			
x	0.2695	0.2710	0.2765	0.2750
y	0.2350	0.2400	0.2400	0.2350

	Rank Btf78db			
x	0.2695	0.2710	0.2765	0.2750
y	0.2350	0.2400	0.2400	0.2350

	Rank Btf78dc			
x	0.2695	0.2710	0.2765	0.2750
y	0.2350	0.2400	0.2400	0.2350

	Rank Btf78dd			
x	0.2695	0.2710	0.2765	0.2750
y	0.2350	0.2400	0.2400	0.2350

	Rank Btf79da			
x	0.2680	0.2695	0.2750	0.2735
y	0.2300	0.2350	0.2350	0.2300

	Rank Btf79db			
x	0.2680	0.2695	0.2750	0.2735
y	0.2300	0.2350	0.2350	0.2300

	Rank Btf79dc			
x	0.2680	0.2695	0.2750	0.2735
y	0.2300	0.2350	0.2350	0.2300

	Rank Btf79dd			
x	0.2680	0.2695	0.2750	0.2735
y	0.2300	0.2350	0.2350	0.2300

Rank Btf80da				
x	0.2665	0.2680	0.2735	0.2720
y	0.2250	0.2300	0.2300	0.2250

Rank Btf80db				
x	0.2665	0.2680	0.2735	0.2720
y	0.2250	0.2300	0.2300	0.2250

Rank Btf80dc				
x	0.2665	0.2680	0.2735	0.2720
y	0.2250	0.2300	0.2300	0.2250

Rank Btf80dd				
x	0.2665	0.2680	0.2735	0.2720
y	0.2250	0.2300	0.2300	0.2250

- * Ranking at $T_s=25^{\circ}\text{C}$.
- * Forward Voltage Tolerance: $\pm 0.05\text{V}$
- * Luminous Flux Tolerance: $\pm 7\%$
- * Chromaticity Coordinate Tolerance: ± 0.005
- * LEDs from the above ranks will be shipped. The rank combination ratio per shipment will be decided by Nichia.

CHROMATICITY DIAGRAM

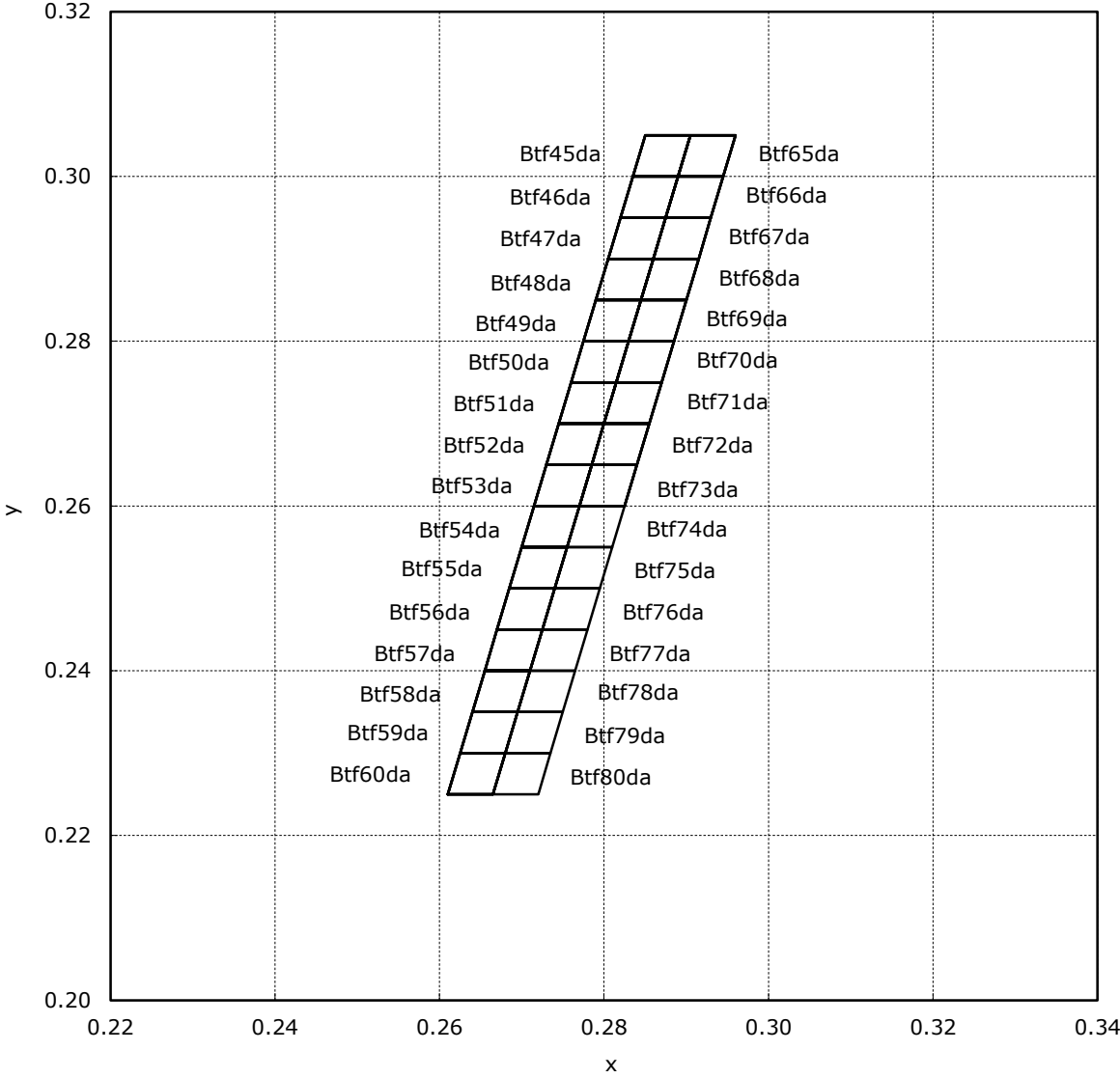

CHROMATICITY DIAGRAM

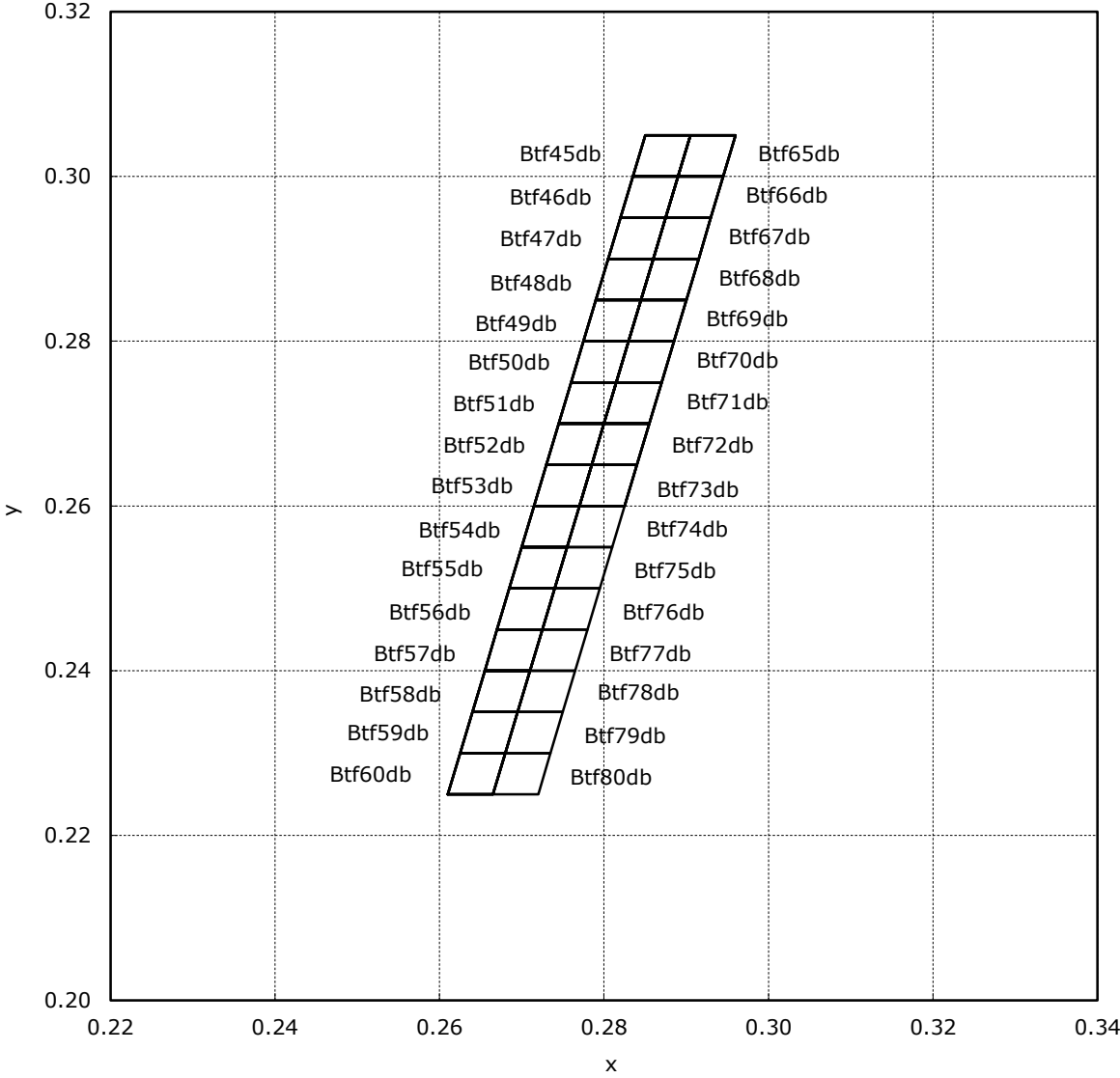

CHROMATICITY DIAGRAM

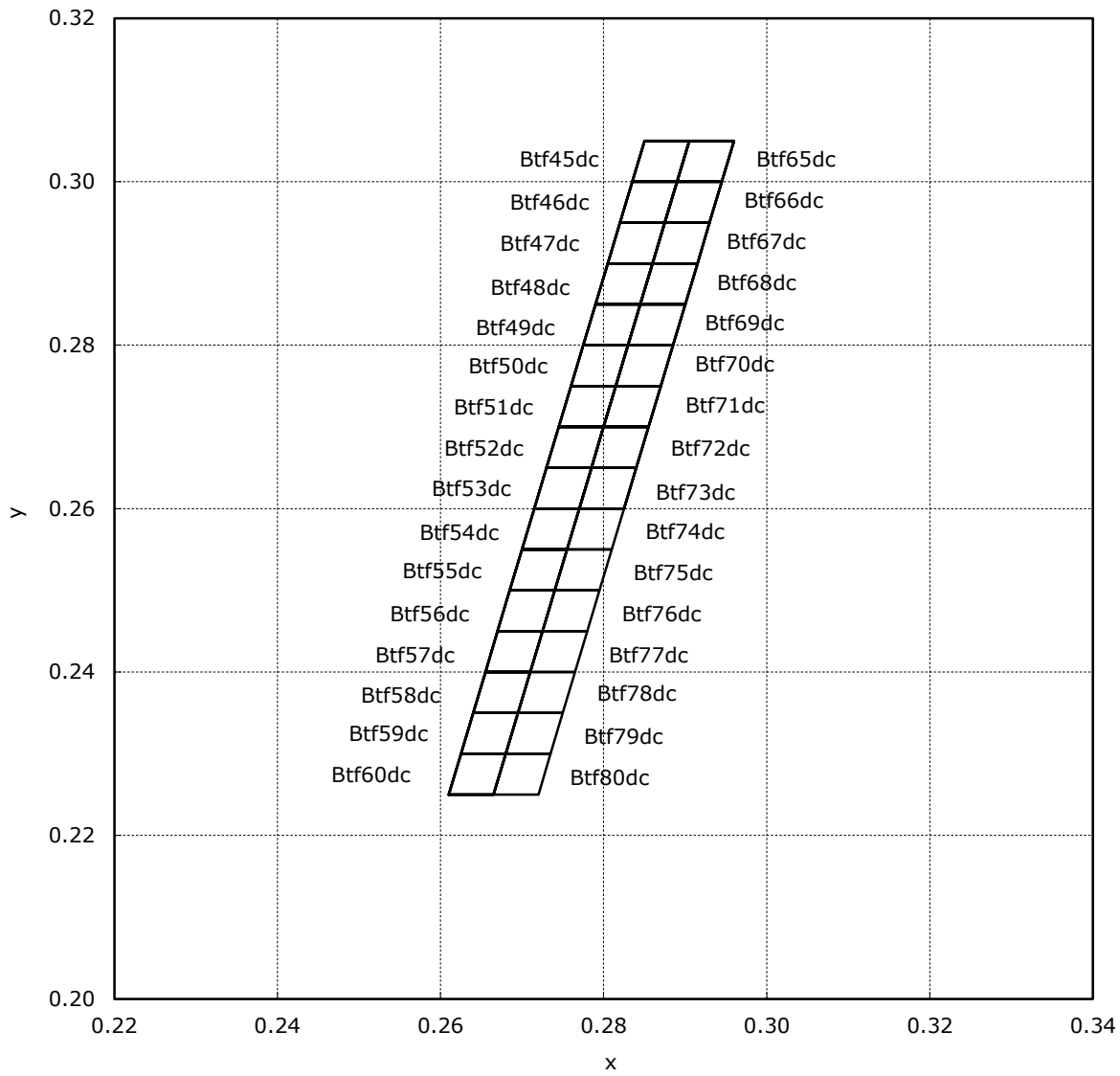

CHROMATICITY DIAGRAM

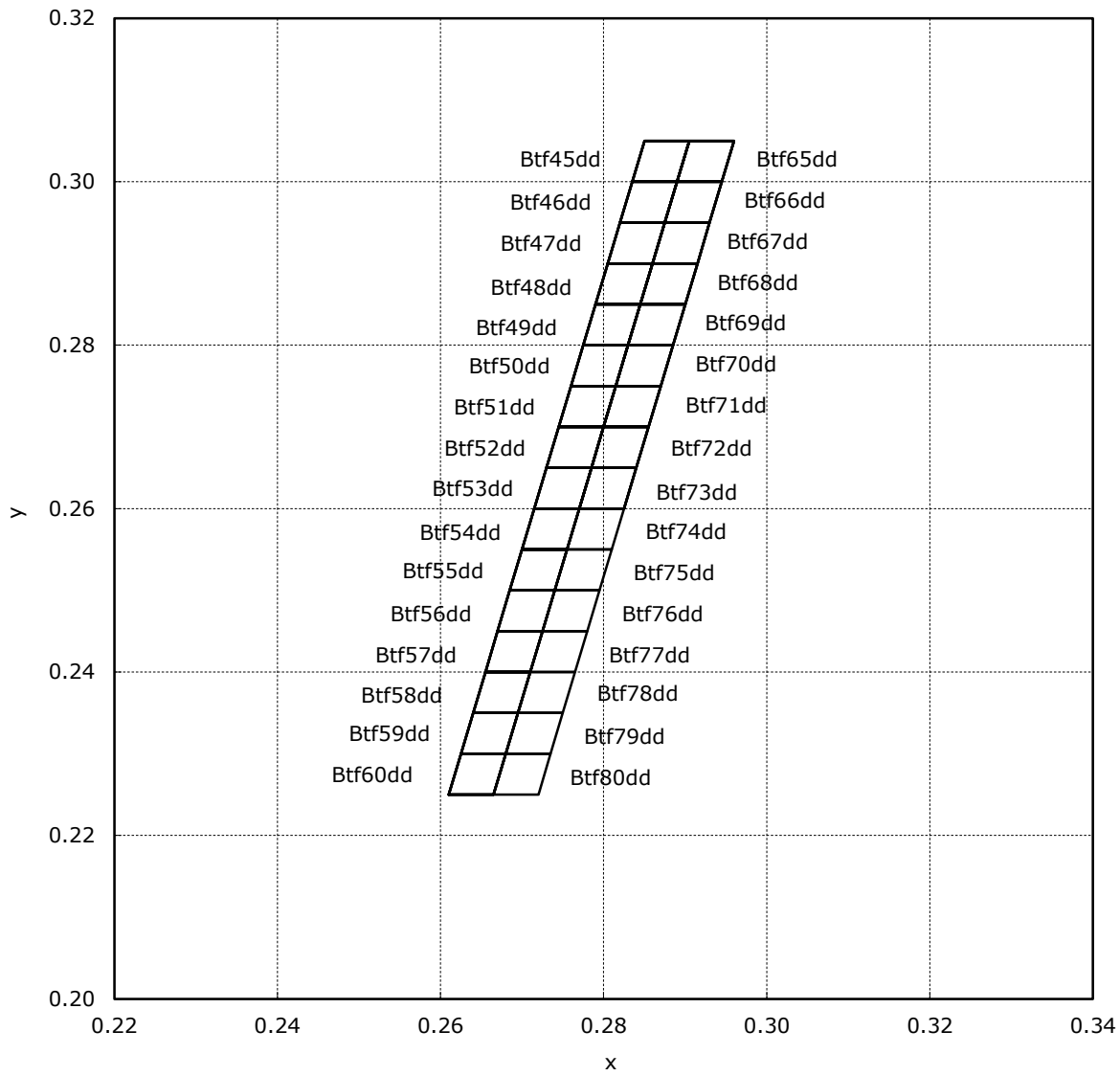

OUTLINE DIMENSIONS

* 本製品はRoHS指令に適合しております。
This product complies with RoHS Directive.

Part No. NJSW157K-HG
No. STS-DA7-16631

* 括弧で囲まれた寸法は参考値です。
The dimension(s) in parentheses are for reference purposes.

(単位 Unit: mm, 公差 Tolerance: ±0.1)

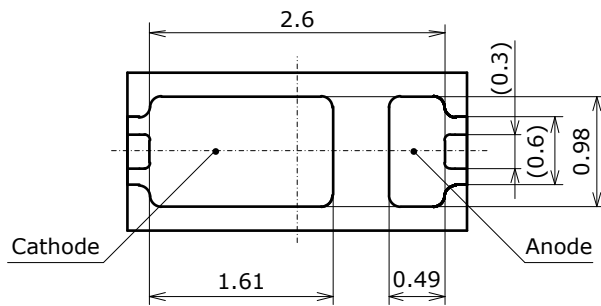
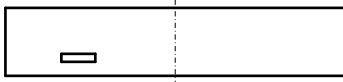
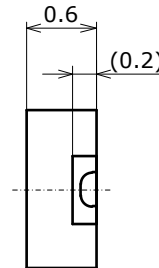
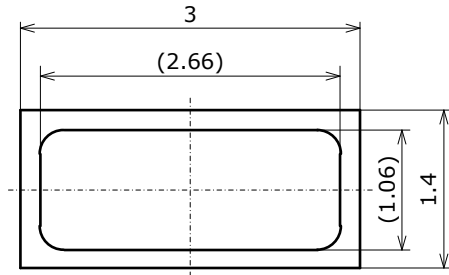

項目 Item	内容 Description
パッケージ材質 Package Materials	耐熱性ポリマー Heat-Resistant Polymer
封止樹脂材質 Encapsulating Resin Materials	シリコン樹脂 (拡散剤+蛍光体入り) Silicone Resin (with diffuser and phosphor)
電極材質 Electrodes Materials	銅合金+銀メッキ Ag-plated Copper Alloy
質量 Weight	0.0086g(TYP)

* バリは寸法に含まないものとします。
Dimensions do not include mold flash or metal burr.

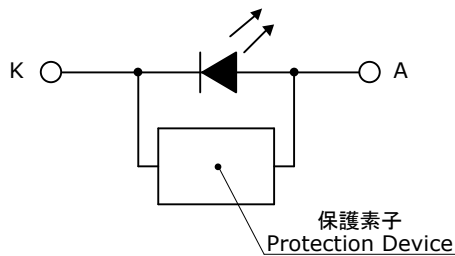

SOLDERING

• Recommended Reflow Soldering Condition(Lead-free Solder)

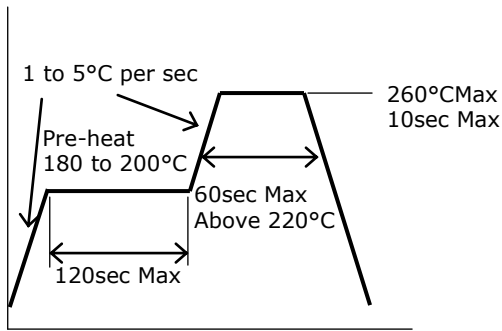

• Recommended Hand Soldering Condition

Temperature	350°C Max
Soldering Time	3sec Max

• Recommended Soldering Pad Pattern

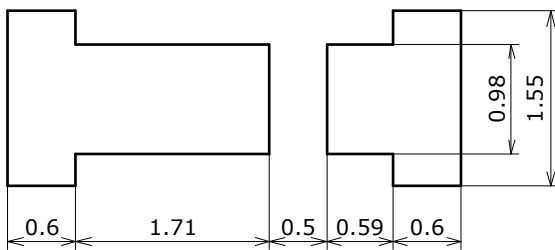

• Recommended Metal Solder Stencil Aperture

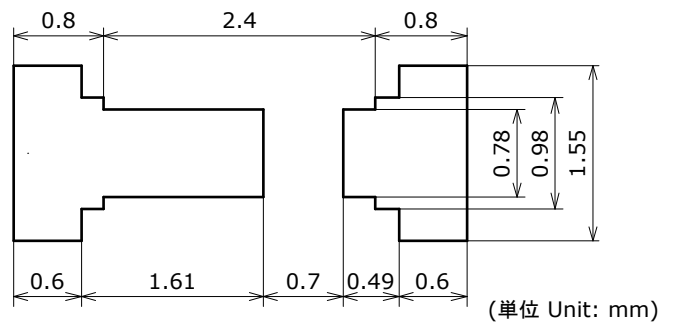

- * This LED is designed to be reflow soldered to a PCB. If dip soldered, Nichia will not guarantee its reliability.
- * Reflow soldering must not be performed more than twice. Hand soldering must not be performed more than once.
- * When cooling the LEDs from the peak temperature a gradual cooling slope is recommended; do not cool the LEDs rapidly.
- * During reflow soldering, the heat and atmosphere in the reflow oven may cause the optical characteristics to degrade. In particular, reflow soldering performed with an air atmosphere may have a greater negative effect on the optical characteristics than if a nitrogen atmosphere is used; Nichia recommends using a nitrogen reflow atmosphere.
- * This LED uses a silicone resin for the encapsulating resin; the silicone resin is soft. If pressure is applied to the silicone resin, it may cause the resin to be damaged, chipped, delaminated and/or deformed. If the resin is damaged, chipped, delaminated and/or deformed, it may cause the wire to break causing a catastrophic failure (i.e. the LED not to illuminate) and/or reliability issues (e.g. the LED to corrode and/or to become dimmer, the color/directivity to change, etc.). Ensure that pressure is not applied to the encapsulating resin.
- * Once the LEDs have been soldered to a PCB, it should not be repaired/reworked. If it must be done, using a double-head soldering iron is strongly recommended. Ensure that sufficient verification is performed prior to use to ensure that the repair/rework has not caused the LED characteristics to deteriorate.
- * When soldering, do not apply stress to the LED while the LED is hot.
- * When using an automatic pick-and-place machine, choose an appropriate nozzle for this LED. Using a pick-and-place nozzle with a smaller diameter than the size of the LED's emitting surface will cause damage to the emitting surface causing a catastrophic failure (i.e. the LED not to illuminate).

* If the top cover tape is removed right next to where the nozzle picks up the LEDs, regardless of whether the LEDs have been baked or not, it may cause the LED to be picked up incorrectly; it is recommended to remove the top cover tape further from where the nozzle picks up the LEDs. Ensure that there are no issues with the conditions when the nozzle picks up the LEDs.

- Recommended Tape Removal Position (Removing the cover tape further from the pick-and-place nozzle)

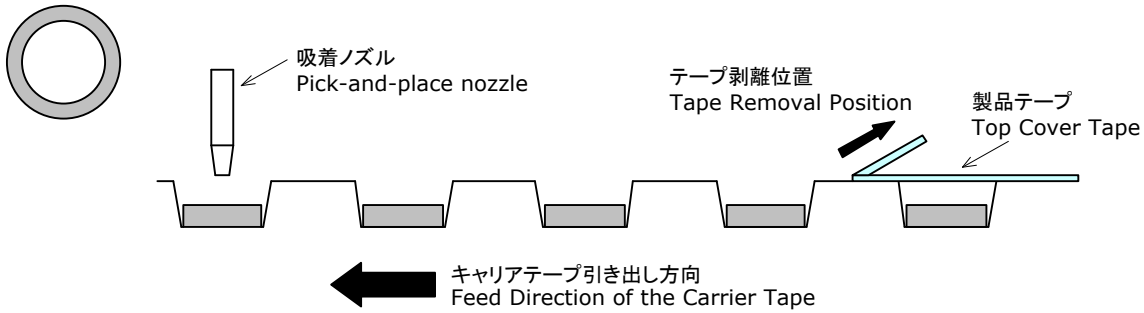

- Incorrect Tape Removal Position (Removing the cover tape right next to the pick-and-place nozzle)

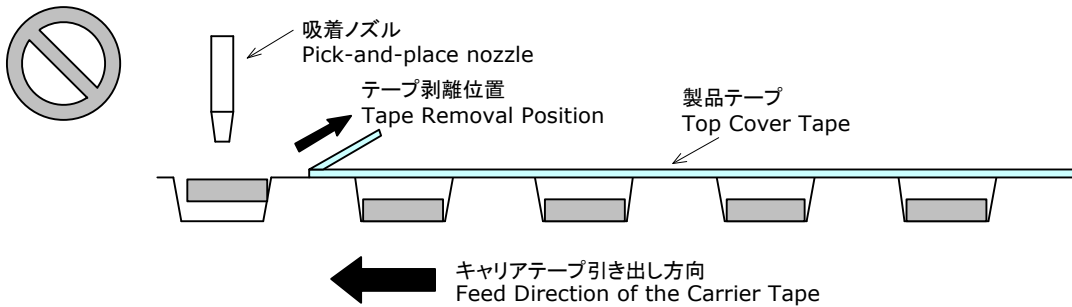

- * The soldering pad pattern above is a general recommendation for LEDs to be mounted without issues; if a high degree of precision is required for the chosen application (i.e. high-density mounting), ensure that the soldering pad pattern is optimized.
- * Consider factors such as the reflow soldering temperature, hand soldering temperature, etc. when choosing the solder.
- * When flux is used, it should be a halogen free flux. Ensure that the manufacturing process is not designed in a manner where the flux will come in contact with the LEDs.
- * Ensure that there are no issues with the type and amount of solder that is being used.

TAPE AND REEL DIMENSIONS

テーピング部 Tape

Nxxx157x
 管理番号 No. STS-DA7-13435
 (単位 Unit: mm)

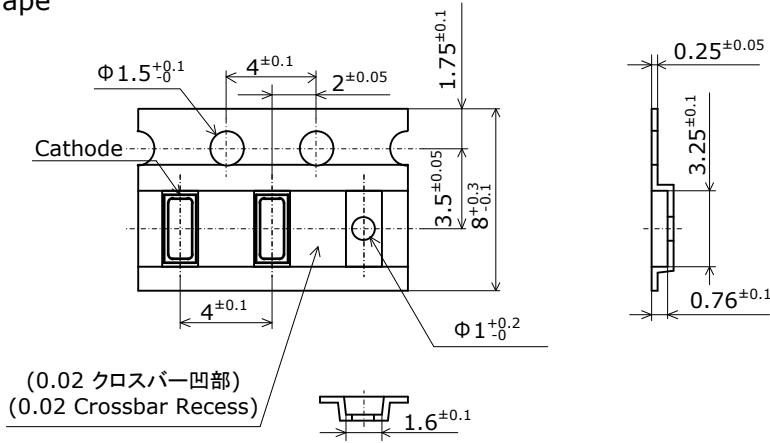

トレーラ部/リーダ部 Trailer and Leader

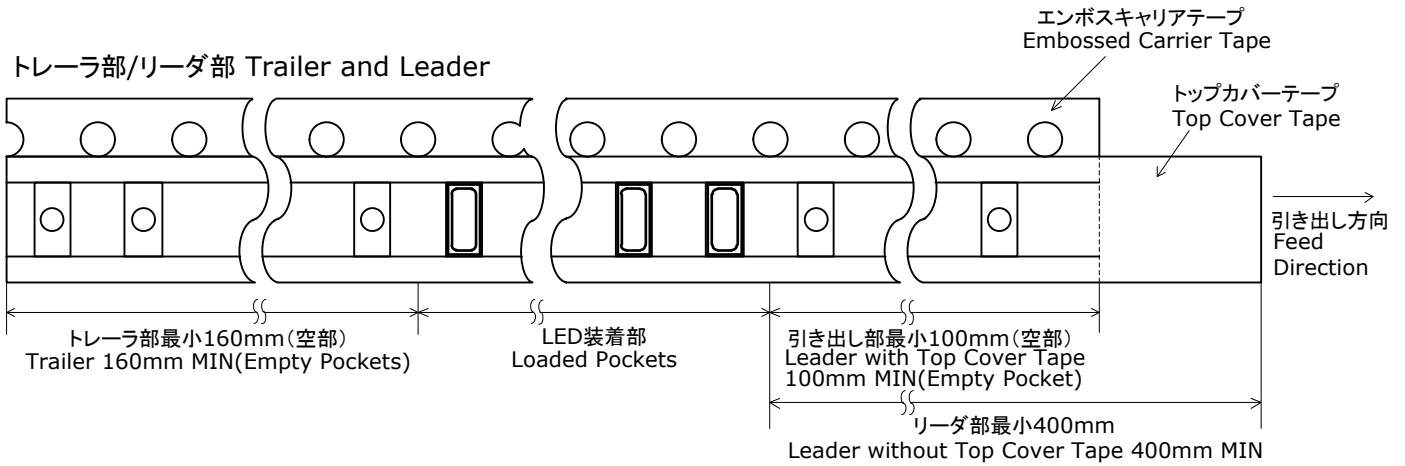

リール部 Reel

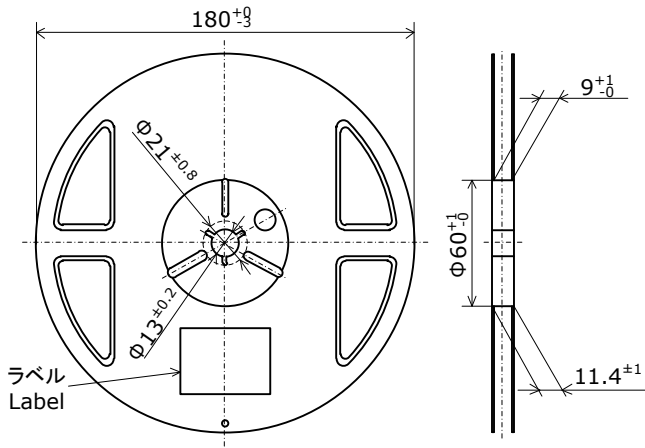

- * 数量は1リールにつき 5000個入りです。
 Reel Size: 5000pcs
- * 実装作業の中断などでエンボスキャリアテープをリールに巻き取る場合、エンボスキャリアテープを強く(10N以上)締めないで下さい。
 LEDがカバーテープに貼り付く可能性があります。
 When the tape is rewound due to work interruptions, no more than 10N should be applied to the embossed carrier tape.
 The LEDs may stick to the top cover tape.
- * JIS C 0806電子部品テーピングに準拠しています。
 The tape packing method complies with JIS C 0806 (Packaging of Electronic Components on Continuous Tapes).

PACKAGING - TAPE & REEL

Reels are shipped with desiccants in heat-sealed moisture-proof bags.
シリカゲルとともにリールをアルミ防湿袋に入れ、熱シールにより封をします。

Part No. Nxxxxxxx
No. STS-DA7-0006F

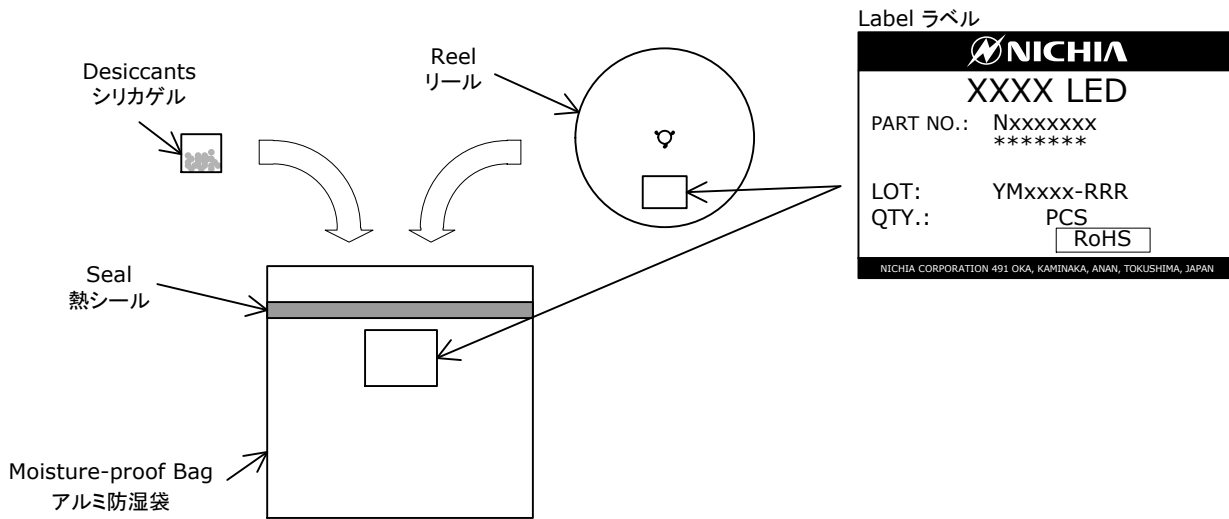

Moisture-proof bags are packed in cardboard boxes with corrugated partitions.
アルミ防湿袋を並べて入れ、ダンボールで仕切ります。

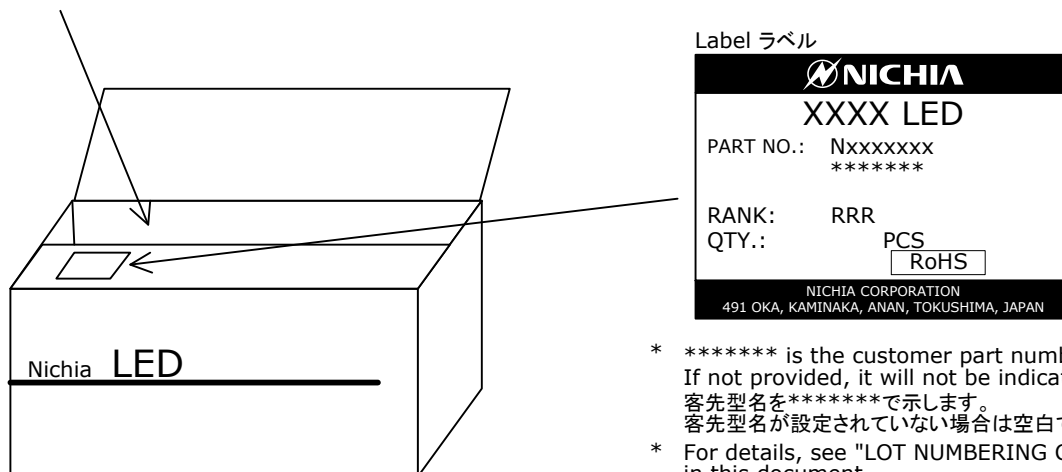

- * ***** is the customer part number. If not provided, it will not be indicated on the label.
客先型名を*****で示します。
客先型名が設定されていない場合は空白です。
- * For details, see "LOT NUMBERING CODE" in this document.
ロット表記方法についてはロット番号の項を参照して下さい。
- * The label does not have the RANK field for un-ranked products.
ランク分けがない場合はランク表記はありません。

- * Products shipped on tape and reel are packed in a moisture-proof bag. They are shipped in cardboard boxes to protect them from external forces during transportation.
本製品はテーピングしたのち、輸送の衝撃から保護するためダンボールで梱包します。
- * Do not drop or expose the box to external forces as it may damage the products.
取り扱いに際して、落下させたり、強い衝撃を与えたりしますと、製品を損傷させる原因になりますので注意して下さい。
- * Do not expose to water. The box is not water-resistant.
ダンボールには防水加工がされておりませんので、梱包箱が水に濡れないよう注意して下さい。
- * Using the original package material or equivalent in transit is recommended.
輸送、運搬に際して弊社よりの梱包状態あるいは同等の梱包を行って下さい。

LOT NUMBERING CODE

Lot Number is presented by using the following alphanumeric code.

YMxxxx - RRR

Y - Year

Year	Y
2019	J
2020	K
2021	L
2022	M
2023	N
2024	O

M - Month

Month	M	Month	M
1	1	7	7
2	2	8	8
3	3	9	9
4	4	10	A
5	5	11	B
6	6	12	C

xxxx-Nichia's Product Number

RRR-Ranking by Color Coordinates, Ranking by Luminous Flux

DERATING CHARACTERISTICS

Part No. NJSW157K-HG
No. STS-DA7-16632

Ambient Temperature vs Allowable Forward Current
周囲温度-許容順電流特性

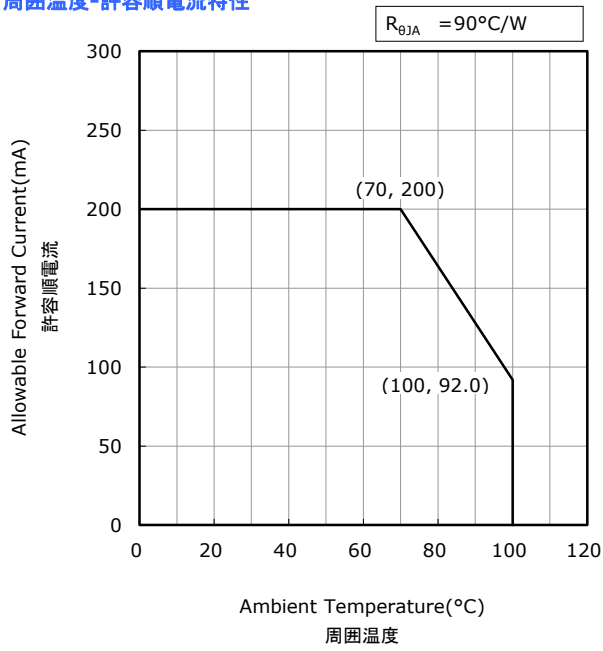

Solder Temperature (Cathode Side) vs Allowable Forward Current
はんだ接合部温度(カソード側)-許容順電流特性

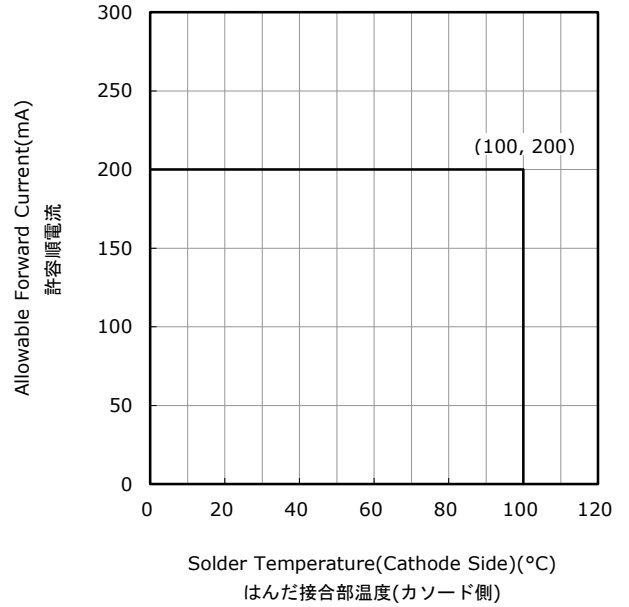

Duty Ratio vs Allowable Forward Current
デューティー比-許容順電流特性

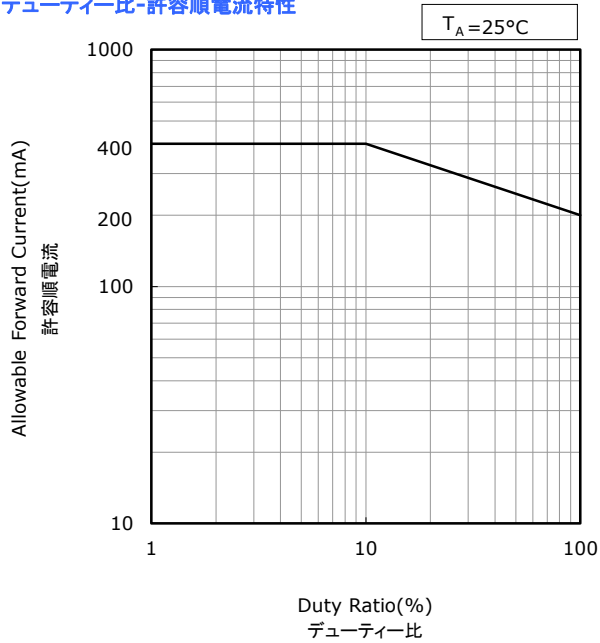

OPTICAL CHARACTERISTICS

* All characteristics shown are for reference only and are not guaranteed.
 本特性は参考です。

Part No. NJSW157K-HG
 No. STS-DA7-16633

Spectrum 発光スペクトル

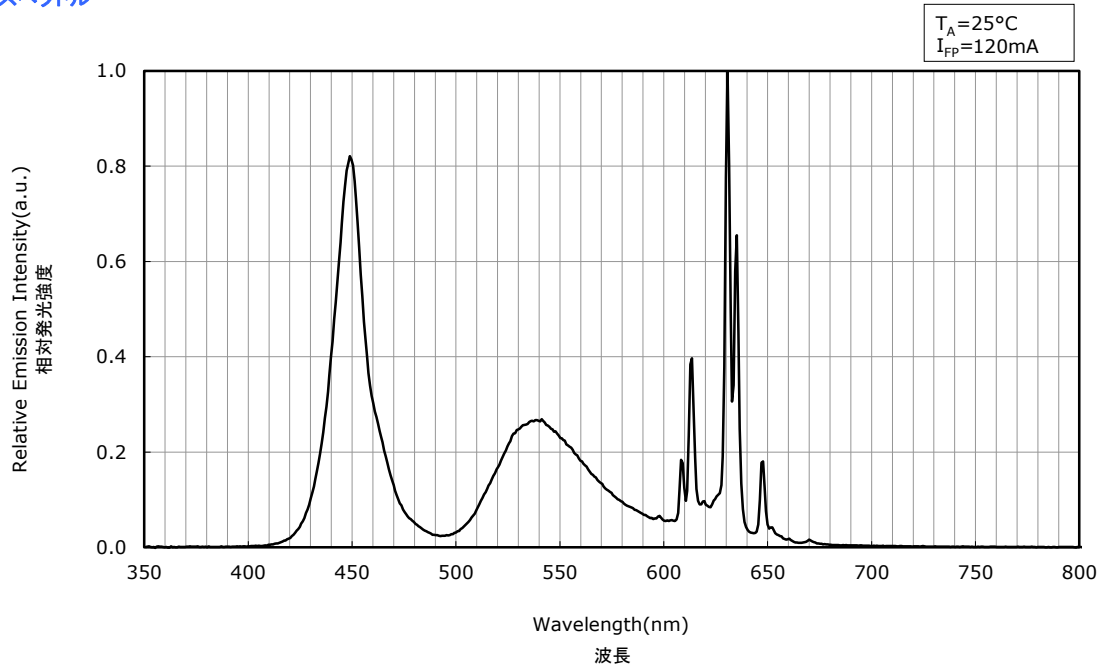

Directivity 指向特性

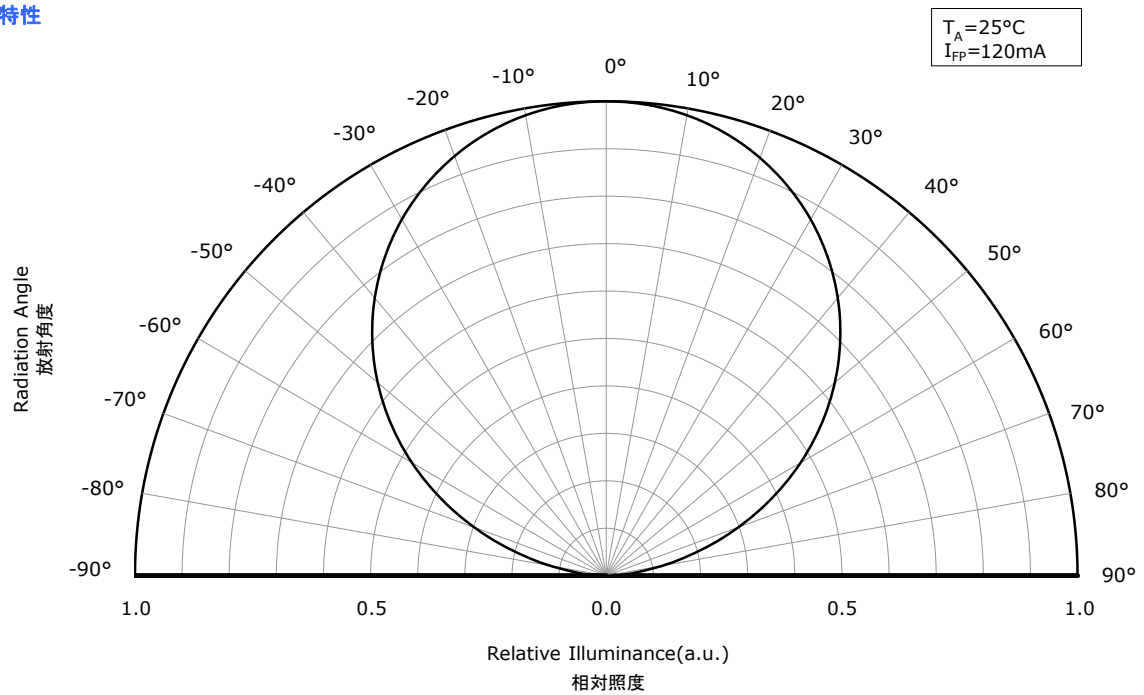

FORWARD CURRENT CHARACTERISTICS / TEMPERATURE CHARACTERISTICS

* All characteristics shown are for reference only and are not guaranteed.
 本特性は参考です。

Part No. NJSW157K-HG
 No. STS-DA7-16634

Forward Voltage vs Forward Current
 順電圧-順電流特性

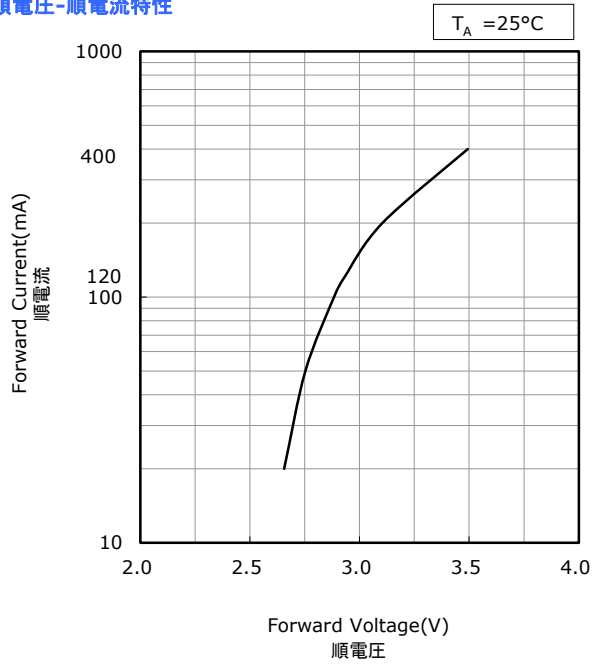

Ambient Temperature vs Forward Voltage
 周囲温度-順電圧特性

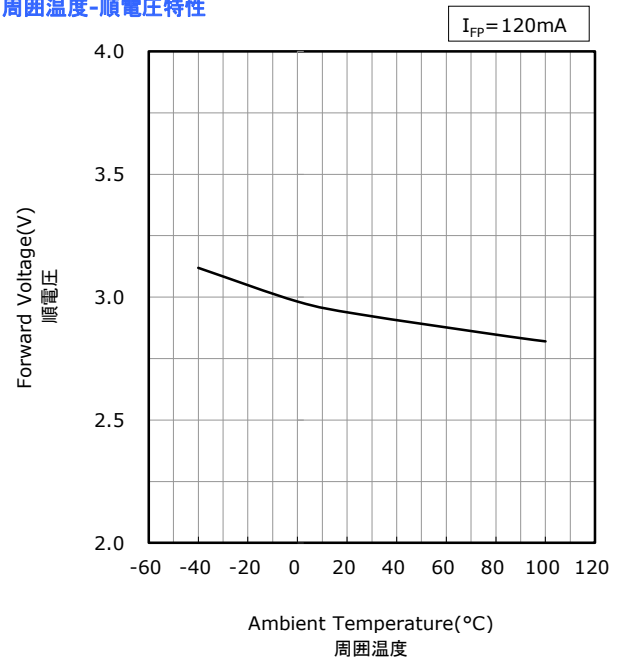

Forward Current vs Relative Luminous Flux
 順電流-相对光束特性

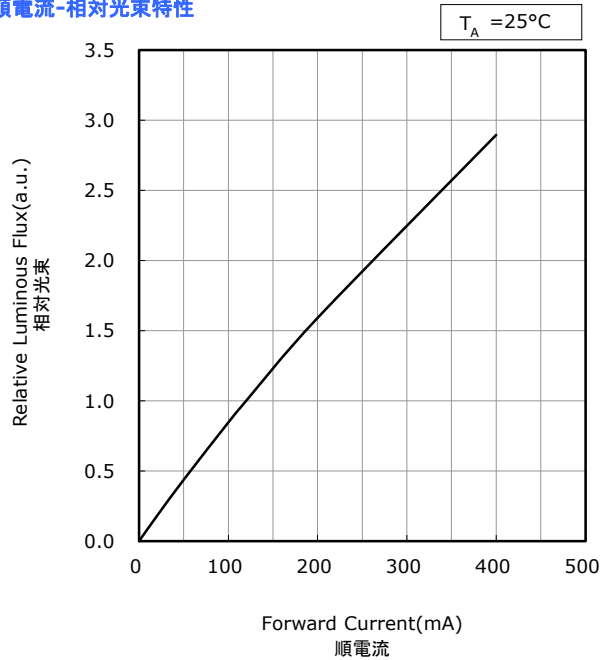

Ambient Temperature vs Relative Luminous Flux
 周囲温度-相对光束特性

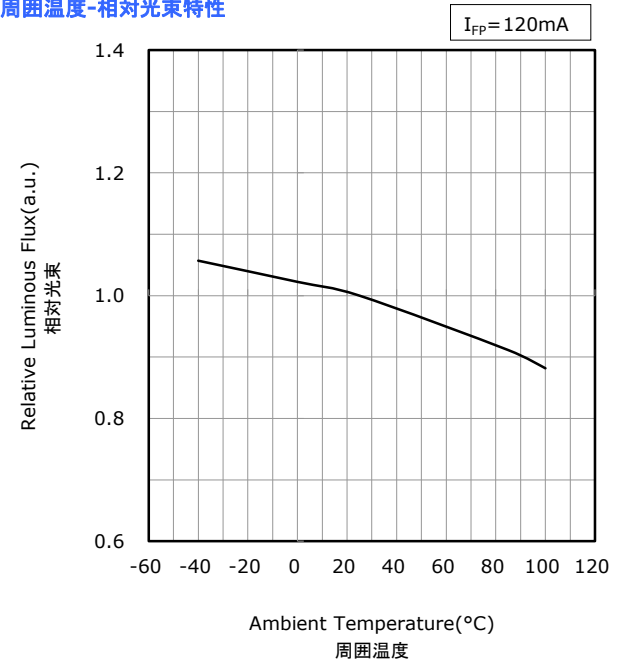

FORWARD CURRENT CHARACTERISTICS / TEMPERATURE CHARACTERISTICS

* All characteristics shown are for reference only and are not guaranteed.
 本特性は参考です。

Part No. NJSW157K-HG
 No. STS-DA7-16635

Forward Current vs Chromaticity Coordinate
順電流-色度 特性

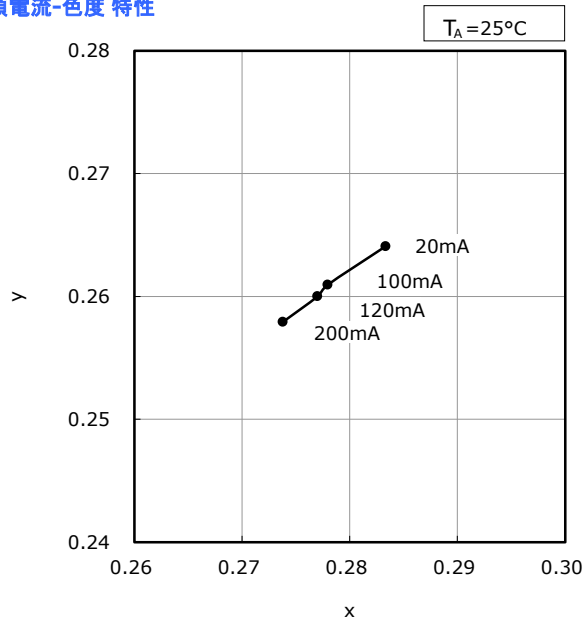

Ambient Temperature vs Chromaticity Coordinate
周囲温度-色度 特性

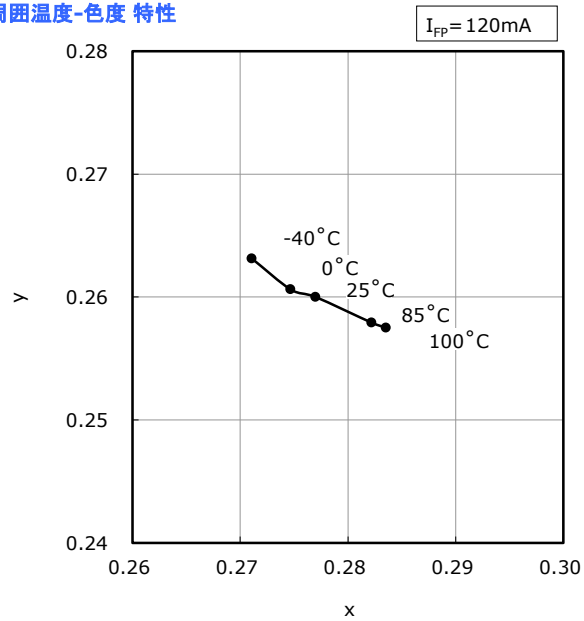

RELIABILITY

(1) Tests and Results

Test	Reference Standard	Test Conditions	Test Duration	Failure Criteria #	Units Failed/Tested
Resistance to Soldering Heat (Reflow Soldering)	JEITA ED-4701 300 301	$T_{\text{slid}}=260^{\circ}\text{C}$, 10sec, 2reflows, Precondition: 30°C , 70%RH, 168hr		#1	0/22
Solderability (Reflow Soldering)	JEITA ED-4701 303 303A	$T_{\text{slid}}=245\pm 5^{\circ}\text{C}$, 5sec, Lead-free Solder(Sn-3.0Ag-0.5Cu)		#2	0/22
Thermal Shock(Air to Air)		-40°C to 100°C , 15min dwell	100cycles	#1	0/22
Moisture Resistance (Cyclic)	JEITA ED-4701 200 203	$25^{\circ}\text{C}\sim 65^{\circ}\text{C}\sim -10^{\circ}\text{C}$, 90%RH, 24hr per cycle	10cycles	#1	0/22
High Temperature Storage	JEITA ED-4701 200 201	$T_{\text{A}}=100^{\circ}\text{C}$	1000hours	#1	0/22
Temperature Humidity Storage	JEITA ED-4701 100 103	$T_{\text{A}}=60^{\circ}\text{C}$, RH=90%	1000hours	#1	0/22
Low Temperature Storage	JEITA ED-4701 200 202	$T_{\text{A}}=-40^{\circ}\text{C}$	1000hours	#1	0/22
Room Temperature Operating Life Condition 1		$T_{\text{A}}=25^{\circ}\text{C}$, $I_{\text{F}}=120\text{mA}$ Test board: See NOTES below	1000hours	#1	0/22
Room Temperature Operating Life Condition 2		$T_{\text{A}}=25^{\circ}\text{C}$, $I_{\text{F}}=200\text{mA}$ Test board: See NOTES below	500hours	#1	0/22
High Temperature Operating Life		$T_{\text{A}}=100^{\circ}\text{C}$, $I_{\text{F}}=85\text{mA}$ Test board: See NOTES below	1000hours	#1	0/22
Temperature Humidity Operating Life		60°C , RH=90%, $I_{\text{F}}=130\text{mA}$ Test board: See NOTES below	500hours	#1	0/22
Low Temperature Operating Life		$T_{\text{A}}=-40^{\circ}\text{C}$, $I_{\text{F}}=120\text{mA}$ Test board: See NOTES below	1000hours	#1	0/22
Electrostatic Discharges	ANSI/ESDA/ JEDEC JS-001	HBM, 8kV, 1.5k Ω , 100pF, 1pulse, alternately positive or negative		#1	0/22

NOTES:

- 1) Test board: FR4 board thickness=1.6mm, copper layer thickness=0.07mm, $R_{\theta\text{JA}}\approx 90^{\circ}\text{C}/\text{W}$
- 2) Measurements are performed after allowing the LEDs to return to room temperature.

(2) Failure Criteria

Criteria #	Items	Conditions	Failure Criteria
#1	Forward Voltage(V_{F})	$I_{\text{F}}=120\text{mA}$	>U.S.L. $\times 1.1$
	Luminous Flux(Φ_{v})	$I_{\text{F}}=120\text{mA}$	<L.S.L. $\times 0.7$
#2	Solderability	-	Less than 95% solder coverage

U.S.L. : Upper Specification Limit L.S.L. : Lower Specification Limit

(3) Reference

The projected average time to 50% lumen maintenance for this product is 30000hours under the conditions of Nichia reliability test: $T_{\text{A}}=60^{\circ}\text{C}$ ($T_{\text{J}}\leq 105^{\circ}\text{C}$), $I_{\text{F}}=120\text{mA}$, Nichia standard circuit board.

CAUTIONS

(1) Storage

Conditions		Temperature	Humidity	Time
Storage	Before Opening Aluminum Bag	≤30°C	≤90%RH	Within 1 Year from Delivery Date
	After Opening Aluminum Bag	≤30°C	≤70%RH	≤168hours
Baking		65±5°C	-	≥24hours

- The storage/packaging requirements for this LED are comparable to JEDEC Moisture Sensitivity Level (MSL) 3 or equivalent. Nichia used IPC/JEDEC STD-020 as a reference to rate the MSL of this LED.
- This LED uses a package that could absorb moisture; if the package absorbs moisture and is exposed to heat during soldering, it may cause the moisture to vaporize and the package to expand and the resulting pressure may cause internal delamination. This may cause the optical characteristics to degrade. To minimize moisture absorption in storage/transit, moisture-proof aluminum bags are used for the LEDs with a silica gel packet to absorb any air moisture in the bag. The silica gel beads turn blue to red as they absorb moisture.
- Once the moisture-proof aluminum bag is open, ensure that the LED is soldered to a PCB within the range of the conditions above. To store any remaining unused LEDs, use a hermetically sealed container with silica gel desiccants. Nichia recommends placing them back to the original moisture-proof bag and reseal it.
- If the "After Opening" storage time has been exceeded or any pink silica gel beads are found, ensure that the LED are baked before use. Baking should only be done once.
- This LED has silver-plated parts both inside and outside of the package. If the LEDs are exposed to a corrosive environment, it may cause the plated surface to tarnish causing issues (i.e. solderability, optical characteristics). Ensure that when storing LEDs, a hermetically sealed container is used. Nichia recommends placing them back to the original moisture-proof bag and reseal it.
- Ensure that when designing, there are no issues with the parts/materials used with the LEDs. The following must be taken into consideration:
 - After soldering LEDs to a PCB and/or installing them in a system, it is possible that the LEDs will be exposed to corrosive gases released from parts/materials used with the LEDs in the same assembly/system (e.g. rubber materials, cardboard boxes) and/or gases entering from the outside; the plated surface may tarnish depending on the gas component.
 - Small amounts of corrosive gas may be found in the air.
 - Resin materials may contain substances (e.g. halogens) that affect the plated surfaces of the LEDs.
- To prevent substances/gases from affecting the plated surface, ensure that the parts/materials used with the LEDs in the same assembly/system do not contain sulfur (e.g. gasket/seal, adhesive, etc.). If the plating becomes extremely corroded or contaminated, it may cause issues (e.g. electrical connection failures). If a gasket/seal is used, silicone rubber gaskets/seals are recommended; ensure that this use of silicone does not result in issues (e.g. electrical connection failures) caused by low molecular weight volatile siloxane.
- To avoid condensation, the LEDs must not be stored in areas where temperature and humidity fluctuate greatly.
- Do not store the LEDs in a dusty environment.
- Do not expose the LEDs to direct sunlight and/or an environment over a long period of time where the temperature is higher than normal room temperature.

(2) Directions for Use

- The circuit must be designed to ensure that the Absolute Maximum Ratings are not exceeded for each LED. The LEDs should be operated at a constant current per LED. In the case of operating at a constant voltage, Circuit B is recommended. If Circuit A is used, it may cause the currents flowing through the LEDs to vary due to the variation in the forward voltage characteristics of the LEDs on the circuit.

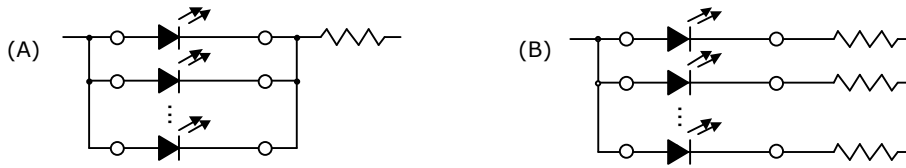

- This LED is designed to be operated at a forward current. Ensure that no voltage is applied to the LED in the forward/reverse direction while the LED is off. If the LEDs are used in an environment where reverse voltages are applied to the LED continuously, it may cause electrochemical migration to occur causing the LED to be damaged. When not in use for a long period of time, the system's power should be turned off to ensure that there are no issues/damage.
- To stabilize the LED characteristics while in use, Nichia recommends that the LEDs are operated at currents $\geq 10\%$ of the sorting current.
- Ensure that transient excessive voltages (e.g. lightning surge) are not applied to the LEDs.
- If the LEDs are used for outdoor applications, ensure that necessary measures are taken (e.g. protecting the LEDs from water/salt damage and high humidity).

(3) Handling Precautions

- Do not handle the LEDs with bare hands:
 - this may contaminate the LED surface and have an effect on the optical characteristics,
 - this may cause the LED to deform and/or the wire to break causing a catastrophic failure (i.e. the LED not to illuminate).
- Ensure that when handling the LEDs with tweezers, excessive force is not applied to the LED. Otherwise, it may cause damage to the resin (e.g. cut, scratch, chip, crack, delamination and deformation) and the wire to break causing a catastrophic failure (i.e. the LED not to illuminate).
- Dropping may cause damage to the LED (e.g. deformation).
- Do not stack assembled PCBs together. Otherwise, it may cause damage to the resin (e.g. cut, scratch, chip, crack, delamination and deformation) and the wire to break causing a catastrophic failure (i.e. the LED not to illuminate).

(4) Design Consideration

- If the LEDs are soldered to a PCB and the PCB assembly is bent (e.g. PCB depaneling process), it may cause the LED package to break. The PCB layout should be designed to minimize the mechanical stress on the LEDs when the PCB assembly is bent/warped.
- The amount of mechanical stress exerted on the LED from depaneling may vary depending on the LED position/orientation on the PCB assembly (e.g. especially in areas near V-groove scores). The PCB layout should be designed to minimize the mechanical stress on the LEDs when the PCB is separated into individual PCB assemblies.
- To separate a PCB populated with the LEDs, use a specially designed tool. Do not break the PCB by hand.
- Volatile organic compounds that have been released from materials present around the LEDs (e.g. housing, gasket/seal, adhesive, secondary lens, lens cover, etc.) may penetrate the LED lens and/or encapsulating resin. If the LEDs are being used in a hermetically sealed environment, these volatile compounds can discolor after being exposed to heat and/or photon energy and it may greatly reduce the LED light output and/or color shift. In this case, ventilating the environment may improve the reduction in light output and/or color shift. Perform a light-up test of the chosen application for optical evaluation to ensure that there are no issues, especially if the LEDs are planned to be used in a hermetically sealed environment.

(5) Electrostatic Discharge (ESD)

- This LED is sensitive to transient excessive voltages (e.g. ESD, lightning surge). If this excessive voltage occurs in the circuit, it may cause the LED to be damaged causing issues (e.g. the LED to become dimmer or not to illuminate [i.e. catastrophic failure]). Ensure that when handling the LEDs, necessary measures are taken to protect them from an ESD discharge. The following examples are recommended measures to eliminate the charge:
 - Grounded wrist strap, ESD footwear, clothes, and floors
 - Grounded workstation equipment and tools
 - ESD table/shelf mat made of conductive materials
- Ensure that all necessary measures are taken to prevent the LEDs from being exposed to transient excessive voltages (e.g. ESD, lightning surge):
 - tools (e.g. soldering irons), jigs, and machines that are used are properly grounded
 - appropriate ESD materials/equipment are used in the work area
 - the system/assembly is designed to provide ESD protection for the LEDs.
- If the tool/equipment used is an insulator (e.g. glass cover, plastic, etc.), ensure that necessary measures have been taken to protect the LED from transient excessive voltages (e.g. ESD). The following examples are recommended measures to eliminate the charge:
 - Dissipating static charge with conductive materials
 - Preventing charge generation with moisture
 - Neutralizing the charge with ionizers
- To detect if an LED was damaged by transient excess voltages (i.e. an ESD event during the system's assembly process), perform a characteristics inspection (e.g. forward voltage measurement, light-up test) at low current ($\leq 1\text{mA}$).
- Failure Criteria: $V_F < 2.0\text{V}$ at $I_F = 0.5\text{mA}$
 If the LED is damaged by transient excess voltages (e.g. ESD), it will cause:
 - the Forward Voltage (V_F) to decrease
 - the LED not to illuminate at a low current

(6) Thermal Management

- The Absolute Maximum Junction Temperature (T_J) must not be exceeded under any circumstances. The increase in the temperature of an LED while in operation may vary depending on the PCB thermal resistance and the density of LEDs on the PCB assembly. Ensure that when using the LEDs for the chosen application, heat is not concentrated in an area and properly managed in the system/assembly.
- The operating current should be determined by considering the temperature conditions surrounding the LED (i.e. T_A). Ensure that when operating the LED, proper measures are taken to dissipate the heat.
- The following two equations can be used to calculate the LED junction temperature:
 - 1) $T_J = T_A + R_{\theta JA} \cdot W$
 - 2) $T_J = T_S + R_{\theta JS} \cdot W$
 - * T_J =LED Junction Temperature: °C
 - T_A =Ambient Temperature: °C
 - T_S =Soldering Temperature (Cathode Side): °C
 - $R_{\theta JA}$ =Thermal Resistance from Junction to Ambient: °C/W
 - $R_{\theta JS}$ =Thermal Resistance from Junction to T_S Measurement Point: °C/W
 - W =Input Power($I_F \times V_F$): W

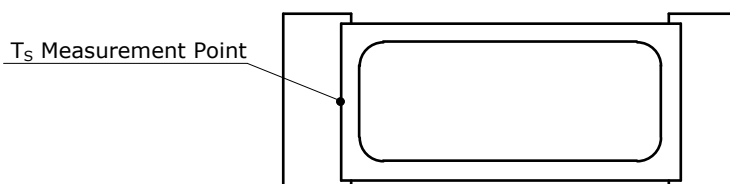

(7) Cleaning

- Do not clean the LEDs with water, benzine and/or thinner.
- To clean the LEDs, use isopropyl alcohol (IPA). If another solvent is used, it may cause the LED package/resin to be damaged causing issues; ensure that sufficient verification is performed prior to use. Additionally, ensure that the solvent being used does not cause any other issues (e.g. CFC-based solvents are heavily regulated).
- If an LED is contaminated (e.g. dust/dirt), use a cloth soaked with isopropyl alcohol (IPA). Ensure that the cloth is firmly squeezed before wiping the LED.
- Do not clean the LEDs with an ultrasonic cleaner. If cleaning must be done, ensure that sufficient verification is performed by using a finished assembly with LEDs to determine cleaning conditions (e.g. ultrasonic power, LED position on the PCB assembly) that do not cause an issue.

(8) Eye Safety

- There may be two important international specifications that should be noted for safe use of the LEDs: IEC 62471:2006 Photobiological safety of lamps and lamp systems and IEC 60825-1:2001 (i.e. Edition 1.2) Safety of Laser Products - Part 1: Equipment Classification and Requirements. Ensure that when using the LEDs, there are no issues with the following points:
 - LEDs have been removed from the scope of IEC 60825-1 since IEC 60825-1:2007 (i.e. Edition 2.0) was published. However, depending on the country/region, there are cases where the requirements of the IEC 60825-1:2001 specifications or equivalent must be adhered to.
 - LEDs have been included in the scope of IEC 62471:2006 since the release of the specification in 2006.
 - Most Nichia LEDs will be classified as the Exempt Group or Risk Group 1 according to IEC 62471:2006. However, in the case of high-power LEDs containing blue wavelengths in the emission spectrum, there are LEDs that will be classified as Risk Group 2 depending on the characteristics (e.g. radiation flux, emission spectrum, directivity, etc.)
 - If the LED is used in a manner that produces an increased output or with an optic to collimate the light from the LED, it may cause damage to the human eye.
- If an LED is operated in a manner that emits a flashing light, it may cause health issues (e.g. visual stimuli causing eye discomfort). The system should be designed to ensure that there are no harmful effects on the human body.

(9) Miscellaneous

- Nichia warrants that the discrete LEDs will meet the requirements/criteria as detailed in the Reliability section within this specification. If the LEDs are used under conditions/environments deviating from or inconsistent with those described in this specification, the resulting damage and/or injuries will not be covered by this warranty.
- Nichia warrants that the discrete LEDs manufactured and/or supplied by Nichia will meet the requirements/criteria as detailed in the Reliability section within this specification; it is the customer's responsibility to perform sufficient verification prior to use to ensure that the lifetime and other quality characteristics required for the intended use are met.
- The applicable warranty period is one year from the date that the LED is delivered. In the case of any incident that appears to be in breach of this warranty, the local Nichia sales representative should be notified to discuss instructions on how to proceed while ensuring that the LED in question is not disassembled or removed from the PCB if it has been attached to the PCB. If a breach of this warranty is proved, Nichia will provide the replacement for the non-conforming LED or an equivalent item at Nichia's discretion. FOREGOING ARE THE EXCLUSIVE REMEDIES AVAILABLE TO THE CUSTOMER IN RESPECT OF THE BREACH OF THE WARRANTY CONTAINED HEREIN, AND IN NO EVENT SHALL NICHIA BE RESPONSIBLE FOR ANY INDIRECT, INCIDENTAL OR CONSEQUENTIAL LOSSES AND/OR EXPENSES (INCLUDING LOSS OF PROFIT) THAT MAY BE SUFFERED BY THE CUSTOMER ARISING OUT OF A BREACH OF THE WARRANTY.
- NICHIA DISCLAIMS ALL OTHER WARRANTIES, EXPRESS OR IMPLIED, INCLUDING THE IMPLIED WARRANTIES OF MERCHANTABILITY AND FITNESS FOR A PARTICULAR PURPOSE.
- This LED is intended to be used for general lighting, household appliances, electronic devices (e.g. mobile communication devices); it is not designed or manufactured for use in applications that require safety critical functions (e.g. aircraft, automobiles, combustion equipment, life support systems, nuclear reactor control system, safety devices, spacecraft, submarine repeaters, traffic control equipment, trains, vessels, etc.). If the LEDs are planned to be used for these applications, unless otherwise detailed in the specification, Nichia will neither guarantee that the LED is fit for that purpose nor be responsible for any resulting property damage, injuries and/or loss of life/health. This LED does not comply with IATF 16949 and is not intended for automotive applications.
- The customer will not reverse engineer, disassemble or otherwise attempt to extract knowledge/design information from the LED.
- All copyrights and other intellectual property rights in this specification in any form are reserved by Nichia or the right holders who have granted Nichia permission to use the content. Without prior written permission from Nichia, no part of this specification may be reproduced in any form or by any means.
- Both the customer and Nichia will agree on the official specifications for the supplied LEDs before any programs are officially launched. Without this agreement in writing (i.e. Customer Specific Specification), changes to the content of this specification may occur without notice (e.g. changes to the foregoing specifications and appearance, discontinuation of the LEDs, etc.).