

NICHIA CORPORATION

SPECIFICATIONS FOR WHITE LED

PART NO. NFSWL11AT-D6

- Pb-free Reflow Soldering Application
- RoHS Compliant

SPECIFICATIONS

(1) Absolute Maximum Ratings

| Item | Symbol | Absolute Maximum Rating | Unit |
|-----------------------|-----------|-------------------------|------|
| Forward Current | I_F | 250 | mA |
| Pulse Forward Current | I_{FP} | 400 | mA |
| Reverse Voltage | V_R | 5 | V |
| Power Dissipation | P_D | 837 | mW |
| Operating Temperature | T_{opr} | -40~105 | °C |
| Storage Temperature | T_{stg} | -40~105 | °C |
| Junction Temperature | T_J | 135 | °C |

* Absolute Maximum Ratings at $T_J=25^\circ\text{C}$.

* I_{FP} conditions with pulse width $\leq 10\text{ms}$ and duty cycle $\leq 10\%$.

* For I_F and I_{FP} , see the "DERATING CHARACTERISTICS" of this specification.

(2) Initial Electrical/Optical Characteristics

| Item | | Symbol | Condition | Typ | Max | Unit |
|--------------------------|---|-----------------|-------------------|--------|-----|---------------|
| Forward Voltage | | V_F | $I_F=65\text{mA}$ | 2.8 | - | V |
| Reverse Current | | I_R | $V_R=5\text{V}$ | - | - | μA |
| R8000 | Luminous Flux (Chromaticity Coordinate1) | Φ_v | $I_F=65\text{mA}$ | 30.1 | - | lm |
| | Color Rendering Index (Chromaticity Coordinate1) | R_a | $I_F=65\text{mA}$ | 82 | - | - |
| Chromaticity Coordinate1 | x | - | $I_F=65\text{mA}$ | 0.4338 | - | - |
| | y | | $I_F=65\text{mA}$ | 0.4030 | - | |
| R8000 | Luminous Flux (Chromaticity Coordinate2) | Φ_v | $I_F=65\text{mA}$ | 32.5 | - | lm |
| | Color Rendering Index (Chromaticity Coordinate2) | R_a | $I_F=65\text{mA}$ | 82 | - | - |
| Chromaticity Coordinate2 | x | - | $I_F=65\text{mA}$ | 0.3447 | - | - |
| | y | | $I_F=65\text{mA}$ | 0.3553 | - | |
| Thermal Resistance | | $R_{\theta JC}$ | - | 1.2 | 2.4 | °C/W |

* Characteristics at $T_J=25^\circ\text{C}$ and measured in pulse mode.

* Optical Characteristics as per CIE 127:2007 standard.

* Chromaticity Coordinates as per CIE 1931 Chromaticity Chart.

* $R_{\theta JC}$ is measured using the Static Mode detailed in JESD51-1.

* The thermal resistance value ($R_{\theta JC}$) is used to perform logical analysis (e.g. computer-based thermal analysis simulation) and represents a thermal resistance between the die to the T_C measurement point (PCB used: Aluminum PCB $t=1.5\text{mm}$, Insulating layer $t=0.12\text{mm}$).

* For more details on thermal resistance, see CAUTIONS, (6) Thermal Management.

RANKS

| Item | Rank | Condition | Min | Max | Unit |
|-----------------------|-------|----------------------|----------------|------|------|
| Forward Voltage | L5 | I _F =65mA | 2.9 | 3.1 | V |
| | L4 | | 2.7 | 2.9 | |
| | K5 | | 2.5 | 2.7 | |
| Reverse Current | - | V _R =5V | - | 50 | μA |
| Luminous Flux | P12 | I _F =65mA | 36.0 | 42.8 | lm |
| | P11 | | 30.3 | 36.0 | |
| | P10 | | 25.5 | 30.3 | |
| | P9 | | 21.4 | 25.5 | |
| Color Rendering Index | R8000 | I _F =65mA | R _a | 80 | - |
| | | | R ₉ | >0 | - |

Color Ranks(I_F=65mA)

The color ranks have chromaticity ranges within 3-step MacAdam ellipse.

| | | Rank sm273 | Rank sm303 | Rank sm353 | Rank sm403 | Rank sm453 | Rank sm503 |
|-----------------------------|-----------------|------------|------------|------------|------------|------------|------------|
| Color Temperature (Unit: K) | T _{CP} | 2700 | 3000 | 3500 | 4000 | 4500 | 5000 |
| Center Point | x | 0.4578 | 0.4338 | 0.4073 | 0.3818 | 0.3611 | 0.3447 |
| | y | 0.4101 | 0.4030 | 0.3917 | 0.3797 | 0.3658 | 0.3553 |
| Minor Axis | a | 0.004056 | 0.004107 | 0.004098 | 0.004071 | 0.003852 | 0.003555 |
| Major Axis | b | 0.007872 | 0.008391 | 0.008796 | 0.009282 | 0.009009 | 0.008418 |
| Ellipse Rotation Angle | Φ | -36.05 | -36.00 | -35.47 | -35.95 | -34.33 | -31.78 |

| | | Rank sm573 | Rank sm653 |
|-----------------------------|-----------------|------------|------------|
| Color Temperature (Unit: K) | T _{CP} | 5700 | 6500 |
| Center Point | x | 0.3287 | 0.3123 |
| | y | 0.3417 | 0.3282 |
| Minor Axis | a | 0.003087 | 0.002709 |
| Major Axis | b | 0.007809 | 0.006561 |
| Ellipse Rotation Angle | Φ | -31.56 | -32.35 |

The color ranks have chromaticity ranges within 5-step MacAdam ellipse.

| | | Rank sm2750a | Rank sm2750b | Rank sm2750c | Rank sm2750d | Rank sm2750e | Rank sm2750f |
|-----------------------------|-----------------|--------------|--------------|--------------|--------------|--------------|--------------|
| Color Temperature (Unit: K) | T _{CP} | 2700 | | | | | |
| Center Point | x | 0.4578 | | | | | |
| | y | 0.4101 | | | | | |
| Minor Axis | a | 0.006760 | | | | | |
| Major Axis | b | 0.013120 | | | | | |
| Ellipse Rotation Angle | Φ | -36.05 | | | | | |

| | | Rank sm3050a | Rank sm3050b | Rank sm3050c | Rank sm3050d | Rank sm3050e | Rank sm3050f |
|--------------------------------|-----------------|-----------------|-----------------|-----------------|-----------------|-----------------|-----------------|
| Color Temperature (Unit: K) | T _{CP} | 3000 | | | | | |
| Center Point | x | 0.4338 | | | | | |
| | y | 0.4030 | | | | | |
| Minor Axis | a | 0.006845 | | | | | |
| Major Axis | b | 0.013985 | | | | | |
| Ellipse Rotation Angle | Φ | -36.00 | | | | | |

| | | Rank sm3550a | Rank sm3550b | Rank sm3550c | Rank sm3550d | Rank sm3550e | Rank sm3550f |
|--------------------------------|-----------------|-----------------|-----------------|-----------------|-----------------|-----------------|-----------------|
| Color Temperature (Unit: K) | T _{CP} | 3500 | | | | | |
| Center Point | x | 0.4073 | | | | | |
| | y | 0.3917 | | | | | |
| Minor Axis | a | 0.006830 | | | | | |
| Major Axis | b | 0.014660 | | | | | |
| Ellipse Rotation Angle | Φ | -35.47 | | | | | |

| | | Rank sm4050a | Rank sm4050b | Rank sm4050c | Rank sm4050d | Rank sm4050e | Rank sm4050f |
|--------------------------------|-----------------|-----------------|-----------------|-----------------|-----------------|-----------------|-----------------|
| Color Temperature (Unit: K) | T _{CP} | 4000 | | | | | |
| Center Point | x | 0.3818 | | | | | |
| | y | 0.3797 | | | | | |
| Minor Axis | a | 0.006785 | | | | | |
| Major Axis | b | 0.015470 | | | | | |
| Ellipse Rotation Angle | Φ | -35.95 | | | | | |

| | | Rank sm4550a | Rank sm4550b | Rank sm4550c | Rank sm4550d | Rank sm4550e | Rank sm4550f |
|--------------------------------|-----------------|-----------------|-----------------|-----------------|-----------------|-----------------|-----------------|
| Color Temperature (Unit: K) | T _{CP} | 4500 | | | | | |
| Center Point | x | 0.3611 | | | | | |
| | y | 0.3658 | | | | | |
| Minor Axis | a | 0.006420 | | | | | |
| Major Axis | b | 0.015015 | | | | | |
| Ellipse Rotation Angle | Φ | -34.33 | | | | | |

| | | Rank sm5050a | Rank sm5050b | Rank sm5050c | Rank sm5050d | Rank sm5050e | Rank sm5050f |
|--------------------------------|-----------------|-----------------|-----------------|-----------------|-----------------|-----------------|-----------------|
| Color Temperature (Unit: K) | T _{CP} | 5000 | | | | | |
| Center Point | x | 0.3447 | | | | | |
| | y | 0.3553 | | | | | |
| Minor Axis | a | 0.005925 | | | | | |
| Major Axis | b | 0.014030 | | | | | |
| Ellipse Rotation Angle | Φ | -31.78 | | | | | |

| | | Rank sm5750a | Rank sm5750b | Rank sm5750c | Rank sm5750d | Rank sm5750e | Rank sm5750f |
|--------------------------------|-----------------|-----------------|-----------------|-----------------|-----------------|-----------------|-----------------|
| Color Temperature (Unit: K) | T _{CP} | 5700 | | | | | |
| Center Point | x | 0.3287 | | | | | |
| | y | 0.3417 | | | | | |
| Minor Axis | a | 0.005145 | | | | | |
| Major Axis | b | 0.013015 | | | | | |
| Ellipse Rotation Angle | Φ | -31.56 | | | | | |

| | | Rank sm6550a | Rank sm6550b | Rank sm6550c | Rank sm6550d | Rank sm6550e | Rank sm6550f |
|--------------------------------|-----------------|-----------------|-----------------|-----------------|-----------------|-----------------|-----------------|
| Color Temperature (Unit: K) | T _{CP} | 6500 | | | | | |
| Center Point | x | 0.3123 | | | | | |
| | y | 0.3282 | | | | | |
| Minor Axis | a | 0.004515 | | | | | |
| Major Axis | b | 0.010935 | | | | | |
| Ellipse Rotation Angle | Φ | -32.35 | | | | | |

The color ranks have chromaticity ranges within 6-step MacAdam ellipse.

| | | Rank sm2760a | Rank sm2760b | Rank sm2760c | Rank sm2760d | Rank sm2760e | Rank sm2760f |
|--------------------------------|-----------------|-----------------|-----------------|-----------------|-----------------|-----------------|-----------------|
| Color Temperature (Unit: K) | T _{CP} | 2700 | | | | | |
| Center Point | x | 0.4578 | | | | | |
| | y | 0.4101 | | | | | |
| Minor Axis | a | 0.008112 | | | | | |
| Major Axis | b | 0.015744 | | | | | |
| Ellipse Rotation Angle | Φ | -36.05 | | | | | |

| | | Rank sm3060a | Rank sm3060b | Rank sm3060c | Rank sm3060d | Rank sm3060e | Rank sm3060f |
|--------------------------------|-----------------|-----------------|-----------------|-----------------|-----------------|-----------------|-----------------|
| Color Temperature (Unit: K) | T _{CP} | 3000 | | | | | |
| Center Point | x | 0.4338 | | | | | |
| | y | 0.4030 | | | | | |
| Minor Axis | a | 0.008214 | | | | | |
| Major Axis | b | 0.016782 | | | | | |
| Ellipse Rotation Angle | Φ | -36.00 | | | | | |

| | | Rank sm3560a | Rank sm3560b | Rank sm3560c | Rank sm3560d | Rank sm3560e | Rank sm3560f |
|--------------------------------|-----------------|-----------------|-----------------|-----------------|-----------------|-----------------|-----------------|
| Color Temperature (Unit: K) | T _{CP} | 3500 | | | | | |
| Center Point | x | 0.4073 | | | | | |
| | y | 0.3917 | | | | | |
| Minor Axis | a | 0.008196 | | | | | |
| Major Axis | b | 0.017592 | | | | | |
| Ellipse Rotation Angle | Φ | -35.47 | | | | | |

| | | Rank sm4060a | Rank sm4060b | Rank sm4060c | Rank sm4060d | Rank sm4060e | Rank sm4060f |
|--------------------------------|-----------------|-----------------|-----------------|-----------------|-----------------|-----------------|-----------------|
| Color Temperature (Unit: K) | T _{CP} | 4000 | | | | | |
| Center Point | x | 0.3818 | | | | | |
| | y | 0.3797 | | | | | |
| Minor Axis | a | 0.008142 | | | | | |
| Major Axis | b | 0.018564 | | | | | |
| Ellipse Rotation Angle | Φ | -35.95 | | | | | |

| | | Rank sm4560a | Rank sm4560b | Rank sm4560c | Rank sm4560d | Rank sm4560e | Rank sm4560f |
|--------------------------------|-----------------|-----------------|-----------------|-----------------|-----------------|-----------------|-----------------|
| Color Temperature (Unit: K) | T _{CP} | 4500 | | | | | |
| Center Point | x | 0.3611 | | | | | |
| | y | 0.3658 | | | | | |
| Minor Axis | a | 0.007704 | | | | | |
| Major Axis | b | 0.018018 | | | | | |
| Ellipse Rotation Angle | Φ | -34.33 | | | | | |

| | | Rank sm5060a | Rank sm5060b | Rank sm5060c | Rank sm5060d | Rank sm5060e | Rank sm5060f |
|--------------------------------|-----------------|-----------------|-----------------|-----------------|-----------------|-----------------|-----------------|
| Color Temperature (Unit: K) | T _{CP} | 5000 | | | | | |
| Center Point | x | 0.3447 | | | | | |
| | y | 0.3553 | | | | | |
| Minor Axis | a | 0.007110 | | | | | |
| Major Axis | b | 0.016840 | | | | | |
| Ellipse Rotation Angle | Φ | -31.78 | | | | | |

| | | Rank sm5760a | Rank sm5760b | Rank sm5760c | Rank sm5760d | Rank sm5760e | Rank sm5760f |
|--------------------------------|-----------------|-----------------|-----------------|-----------------|-----------------|-----------------|-----------------|
| Color Temperature (Unit: K) | T _{CP} | 5700 | | | | | |
| Center Point | x | 0.3287 | | | | | |
| | y | 0.3417 | | | | | |
| Minor Axis | a | 0.006174 | | | | | |
| Major Axis | b | 0.015618 | | | | | |
| Ellipse Rotation Angle | Φ | -31.56 | | | | | |

| | | Rank sm6560a | Rank sm6560b | Rank sm6560c | Rank sm6560d | Rank sm6560e | Rank sm6560f |
|--------------------------------|----------|-----------------|-----------------|-----------------|-----------------|-----------------|-----------------|
| Color Temperature (Unit: K) | T_{CP} | 6500 | | | | | |
| Center Point | x | 0.3123 | | | | | |
| | y | 0.3282 | | | | | |
| Minor Axis | a | 0.005418 | | | | | |
| Major Axis | b | 0.013122 | | | | | |
| Ellipse Rotation Angle | Φ | -32.35 | | | | | |

- * Ranking at $T_J=25^\circ\text{C}$ and measured in pulse mode.
- * Forward Voltage Tolerance: $\pm 0.05\text{V}$
- * Luminous Flux Tolerance: $\pm 6\%$
- * Color Rendering Index R_a Tolerance: ± 2
- * Color Rendering Index R_9 Tolerance: ± 6.5
- * Chromaticity Coordinate Tolerance: ± 0.006
- * LEDs from the above ranks will be shipped. The rank combination ratio per shipment will be decided by Nichia.

Definition of the MacAdam ellipse ranks:

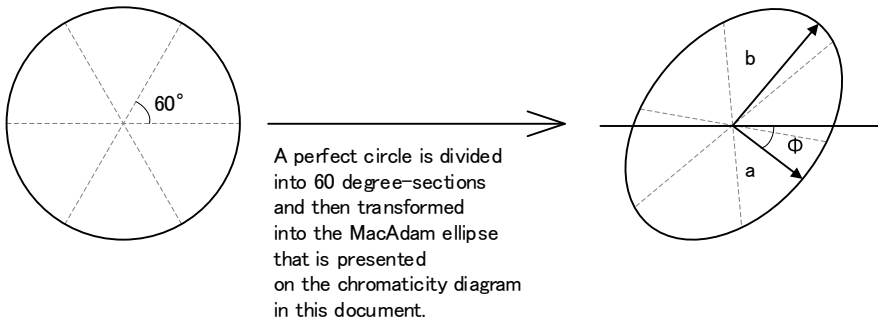

Luminous Flux Ranks by Color Rank, Color Rendering Index Rank

| Ranking by Color Coordinates, Color Rendering Index | | Ranking by Luminous Flux | | | |
|---|-------|-----------------------------|-----|-----|-----|
| | | P9 | P10 | P11 | P12 |
| sm273,sm2750a,sm2750b,sm2750c,sm2750d,sm2750e,sm2750f, sm2760a,sm2760b,sm2760c,sm2760d,sm2760e,sm2760f, sm303,sm3050a,sm3050b,sm3050c,sm3050d,sm3050e,sm3050f, sm3060a,sm3060b,sm3060c,sm3060d,sm3060e,sm3060f | R8000 | | | | |
| sm353,sm3550a,sm3550b,sm3550c,sm3550d,sm3550e,sm3550f, sm3560a,sm3560b,sm3560c,sm3560d,sm3560e,sm3560f, sm403,sm4050a,sm4050b,sm4050c,sm4050d,sm4050e,sm4050f, sm4060a,sm4060b,sm4060c,sm4060d,sm4060e,sm4060f, sm453,sm4550a,sm4550b,sm4550c,sm4550d,sm4550e,sm4550f, sm4560a,sm4560b,sm4560c,sm4560d,sm4560e,sm4560f, sm503,sm5050a,sm5050b,sm5050c,sm5050d,sm5050e,sm5050f, sm5060a,sm5060b,sm5060c,sm5060d,sm5060e,sm5060f, sm573,sm5750a,sm5750b,sm5750c,sm5750d,sm5750e,sm5750f, sm5760a,sm5760b,sm5760c,sm5760d,sm5760e,sm5760f, sm653,sm6550a,sm6550b,sm6550c,sm6550d,sm6550e,sm6550f, sm6560a,sm6560b,sm6560c,sm6560d,sm6560e,sm6560f | R8000 | | | | |

CHROMATICITY DIAGRAM

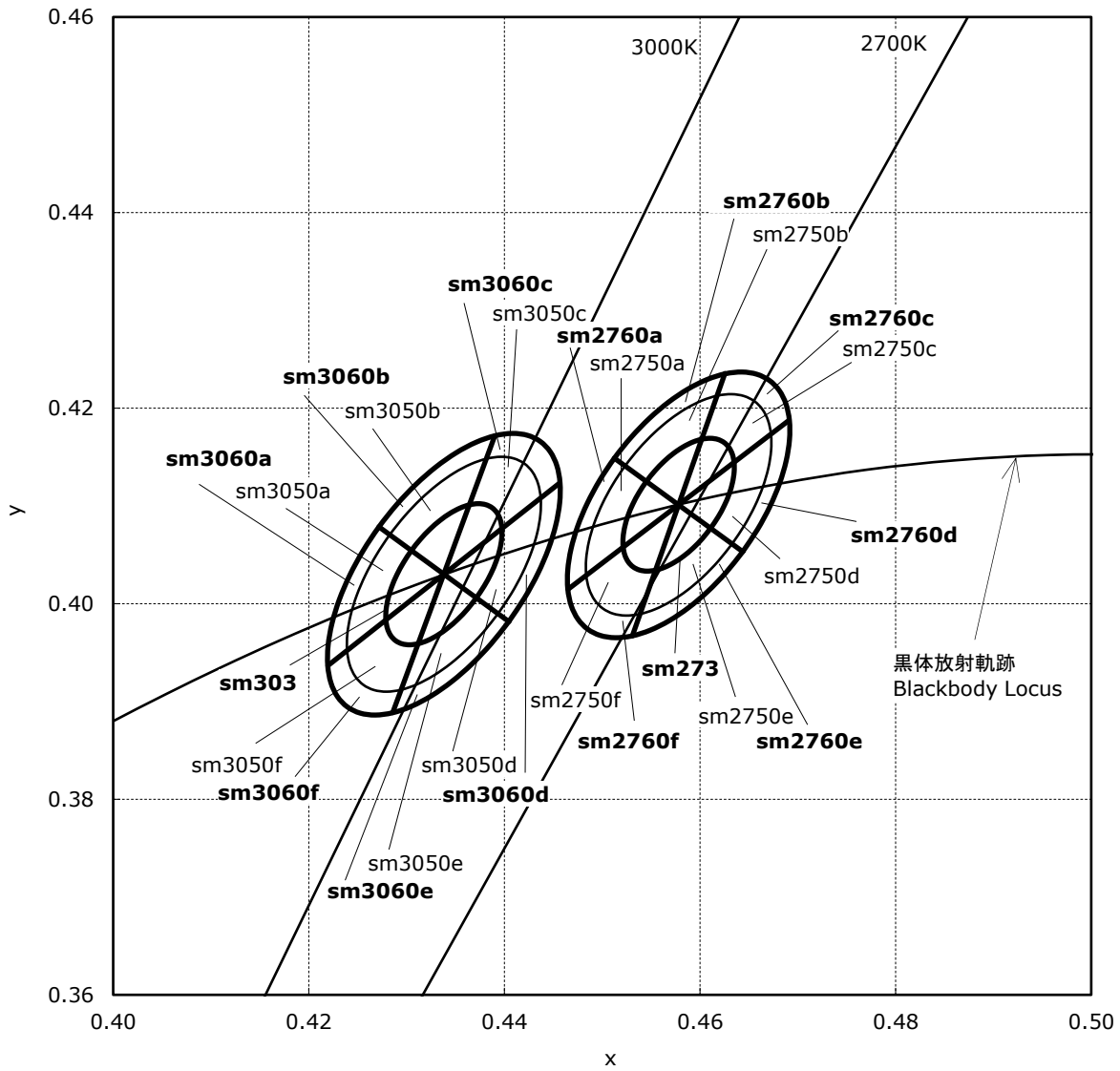

CHROMATICITY DIAGRAM

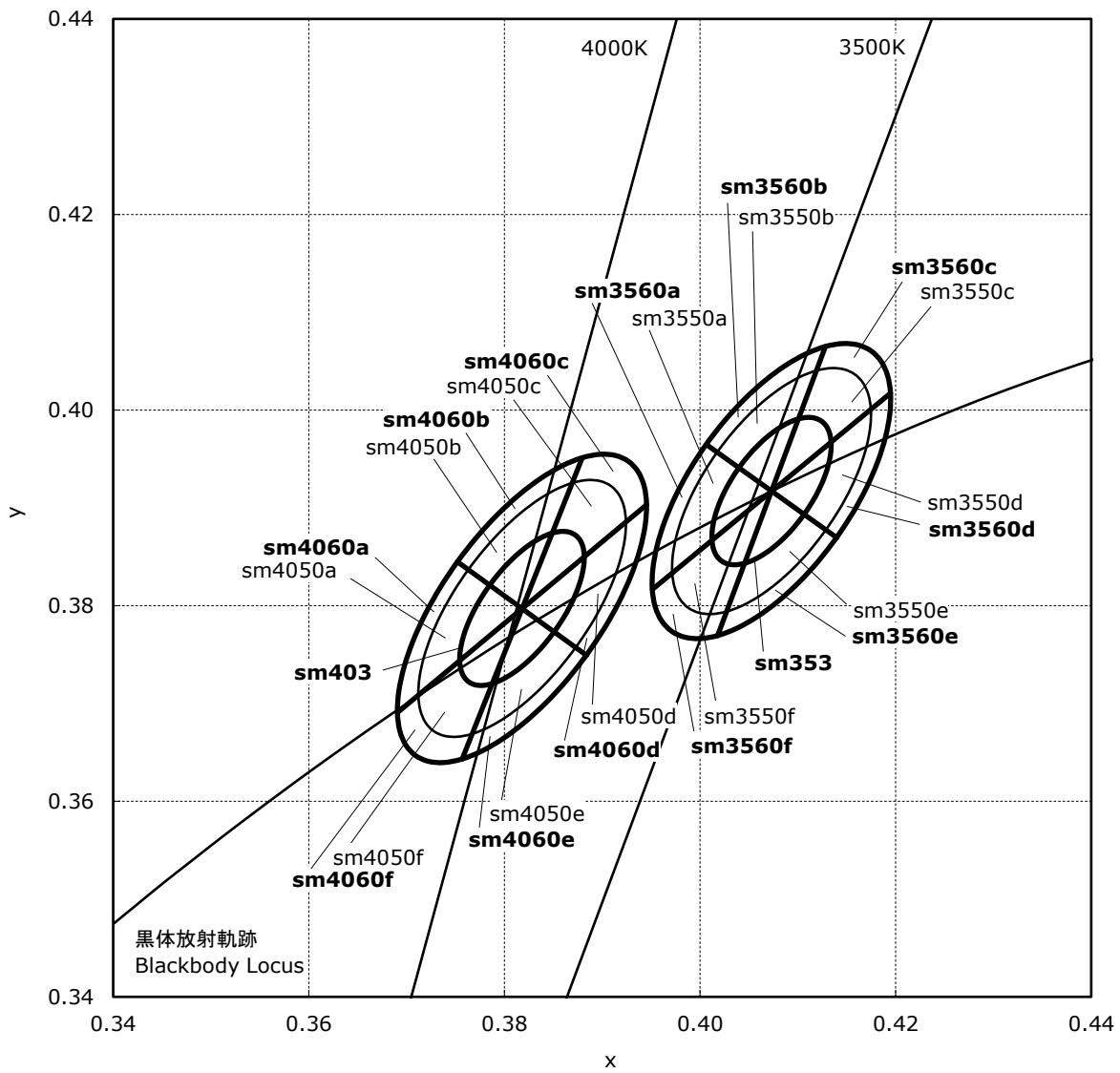

CHROMATICITY DIAGRAM

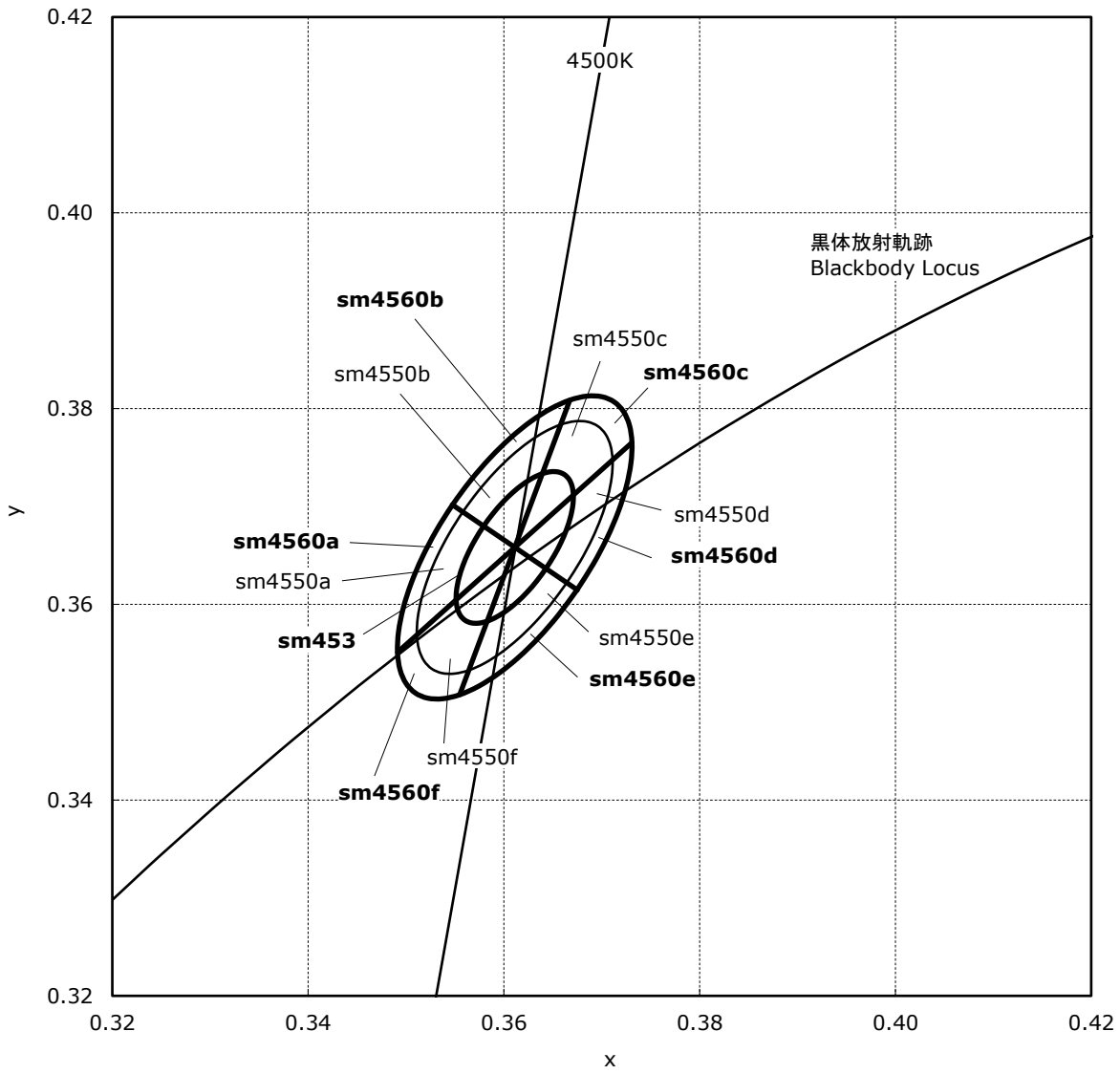

CHROMATICITY DIAGRAM

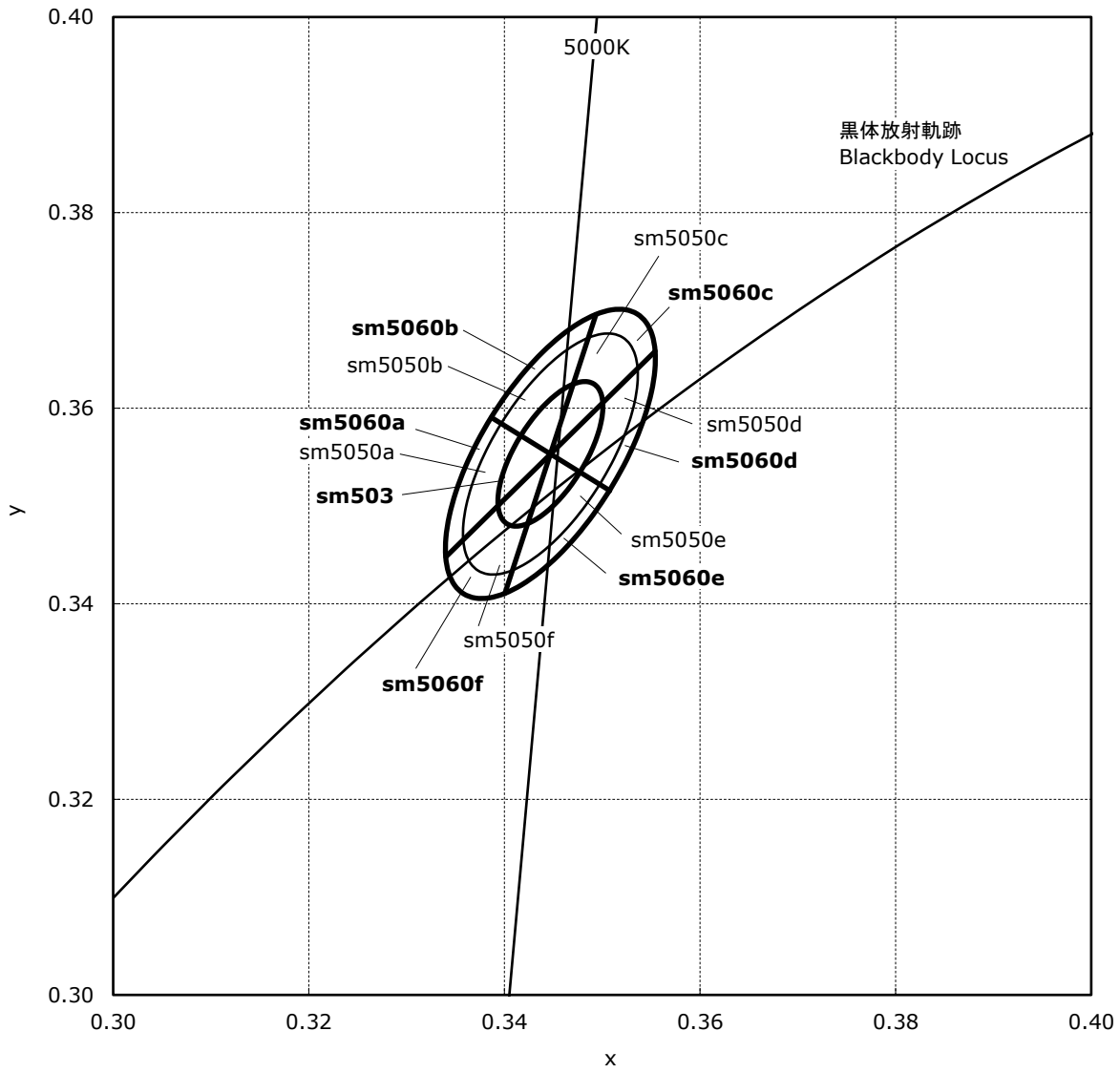

CHROMATICITY DIAGRAM

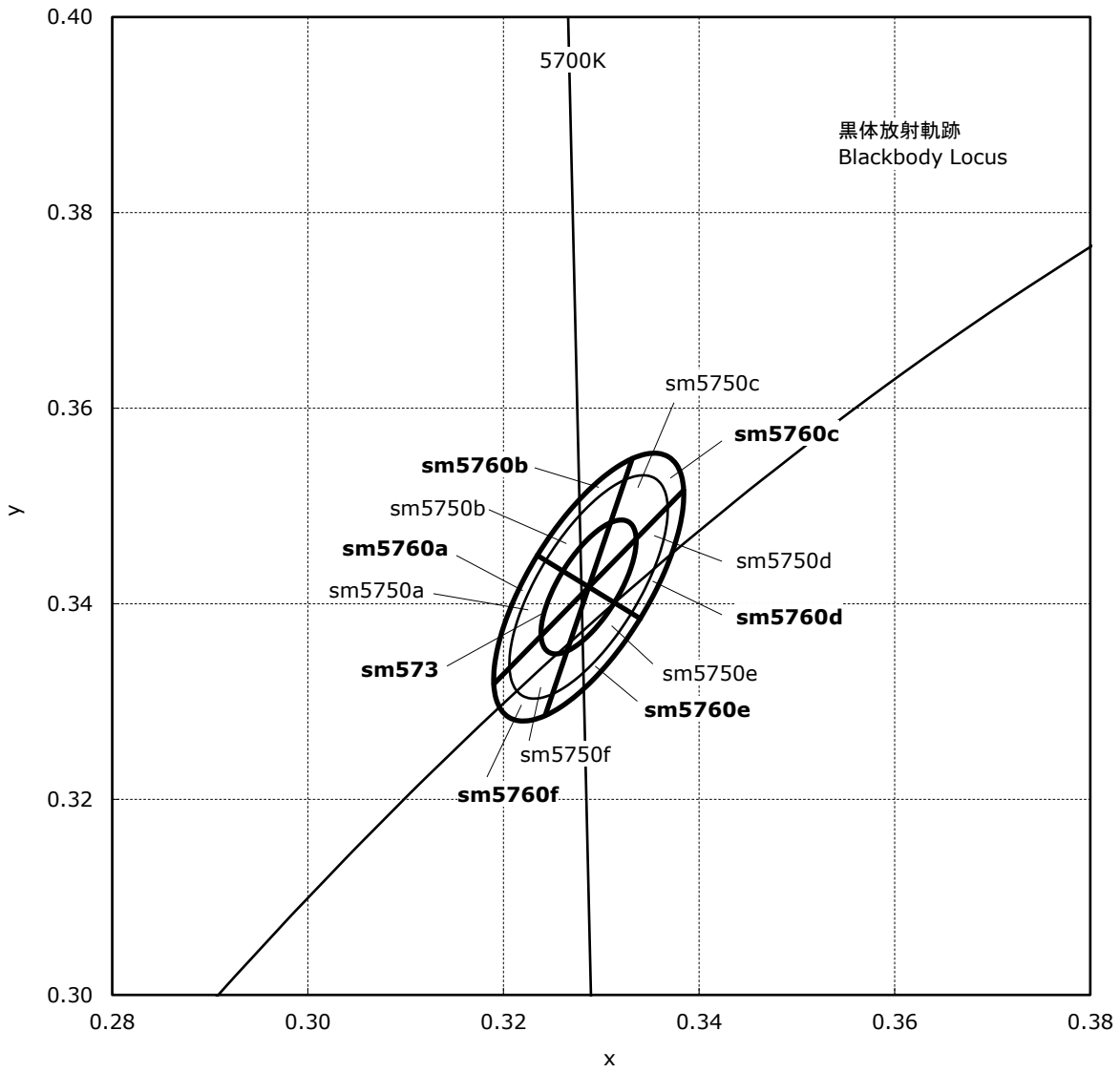

CHROMATICITY DIAGRAM

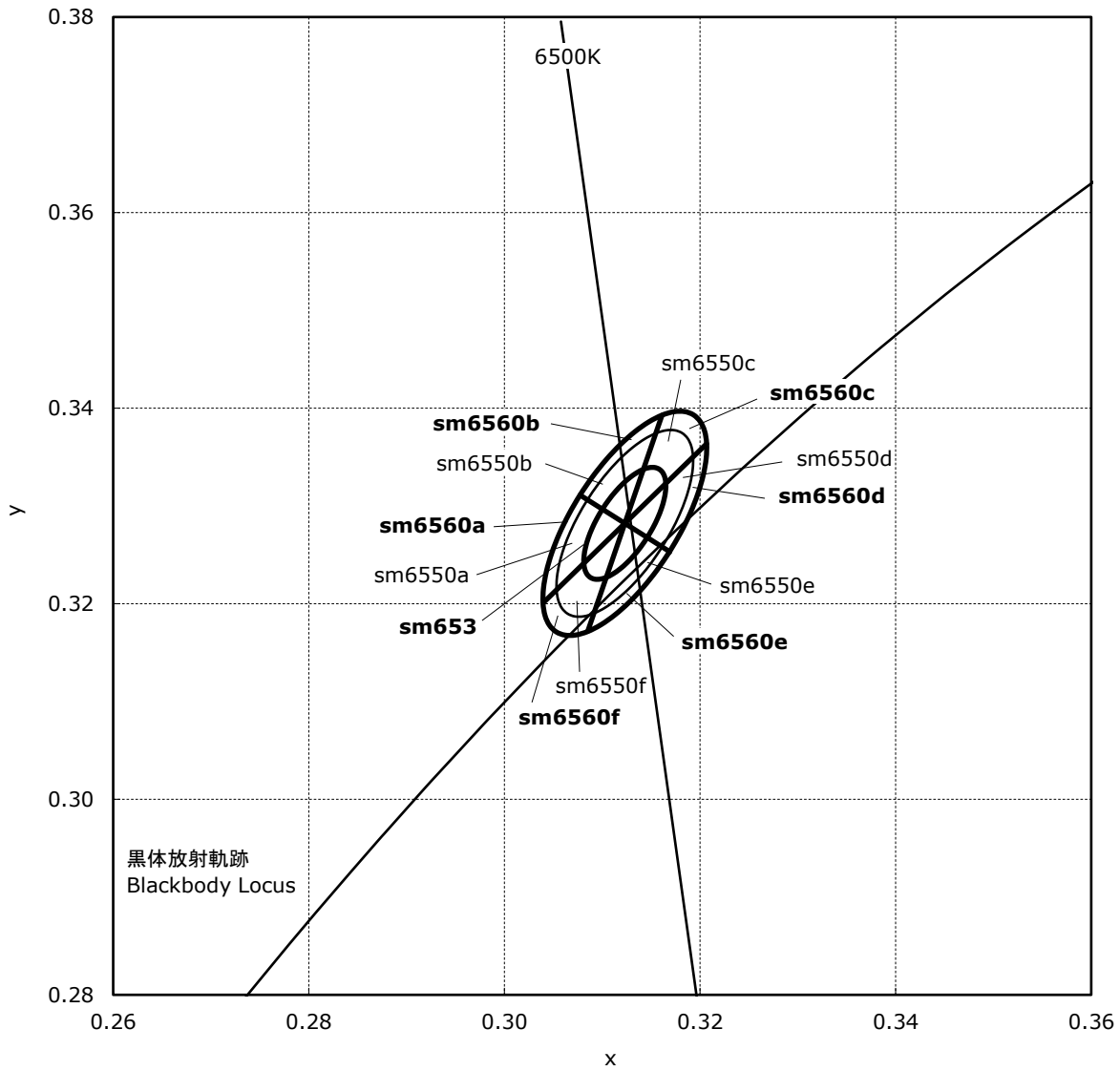

OUTLINE DIMENSIONS

* 本製品はRoHS指令に適合しております。
This product complies with RoHS Directive.

Part No. NFSWL11A-D6
No. STS-DA7-20376

(単位 Unit: mm, 公差 Tolerance: ±0.1)

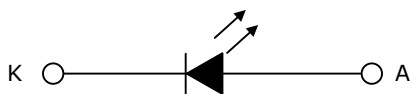
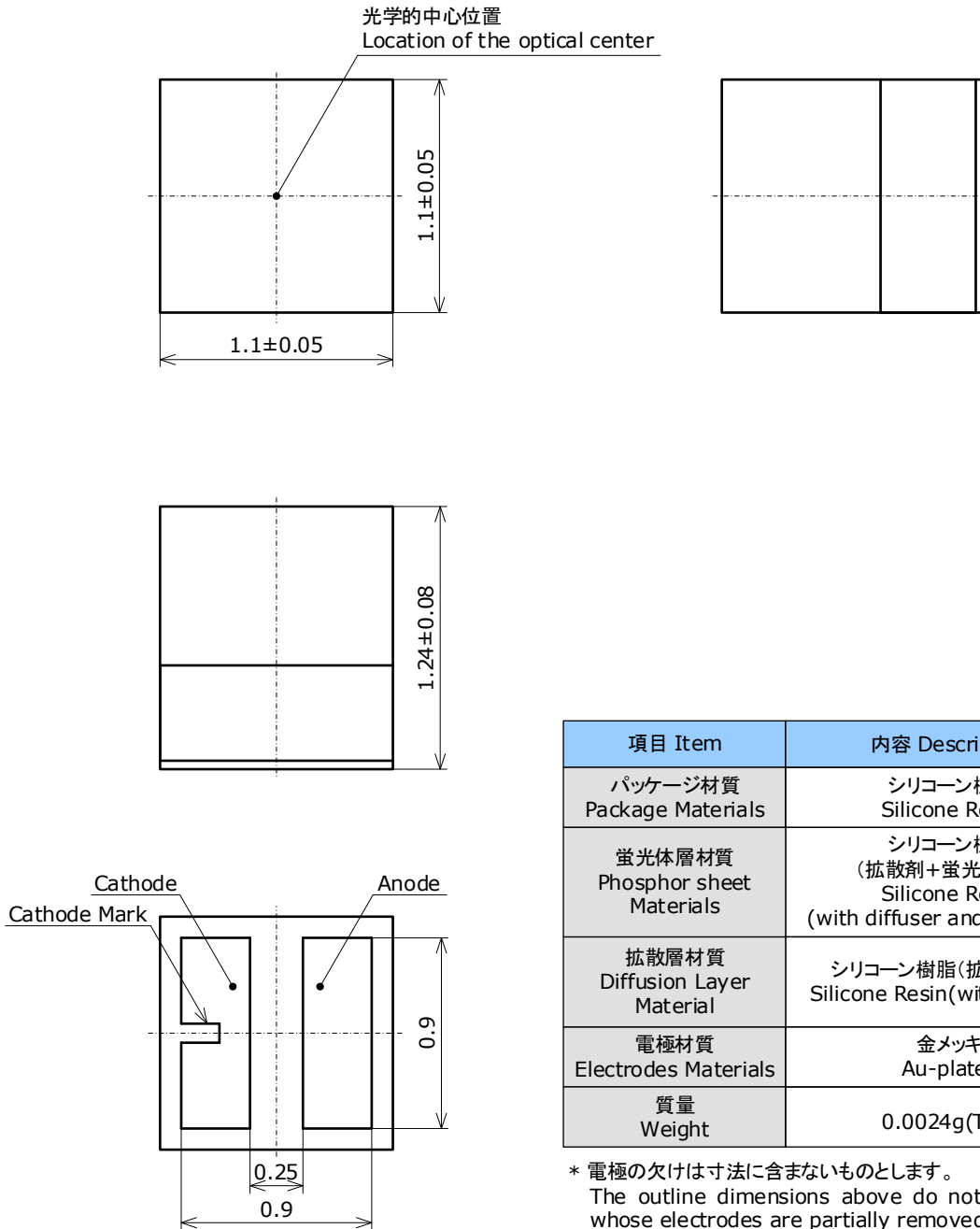

SOLDERING

• Reflow Soldering Condition(Lead-free Solder)

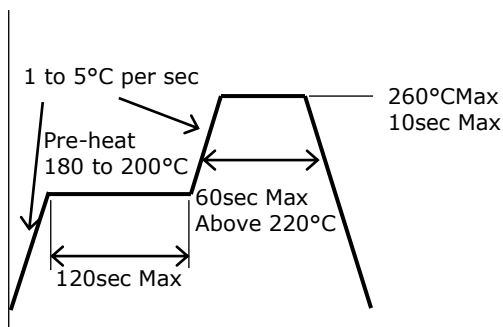

• Recommended Soldering Pad Pattern

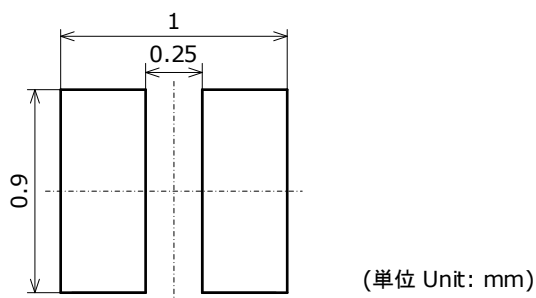

- * This LED is designed to be reflow soldered to a PCB. If dip soldered or hand soldered, Nichia will not guarantee its reliability.
- * Reflow soldering must not be performed more than twice.
- * When cooling the LEDs from the peak temperature a gradual cooling slope is recommended; do not cool the LEDs rapidly.
- * During reflow soldering, the heat and atmosphere in the reflow oven may cause the optical characteristics to degrade. In particular, reflow soldering performed with an air atmosphere may have a greater negative effect on the optical characteristics than if a nitrogen atmosphere is used; Nichia recommends using a nitrogen reflow atmosphere.
- * This LED uses a silicone resin for the encapsulating resin; the silicone resin is soft. If pressure is applied to the silicone resin, it may cause the resin to be damaged, chipped, delaminated and/or deformed. If the resin is damaged, chipped, delaminated and/or deformed, it may cause the internal connection to fail causing a catastrophic failure (i.e. the LED not to illuminate) and/or reliability issues (e.g. the LED to corrode and/or to become dimmer, the color/directivity to change, etc.). Ensure that pressure is not applied to the encapsulating resin.
- * Once the LEDs have been soldered to a PCB, it should not be repaired/reworked.
- * When soldering, do not apply stress to the LED while the LED is hot.
- * When using an automatic pick-and-place machine, choose an appropriate nozzle for this LED.
Max. force: 5N
- * The soldering pad pattern above is a general recommendation for the LEDs to be mounted without issues; if a high degree of precision is required for the chosen application (i.e. high-density mounting) and changes/modifications are made to this soldering pad pattern, the distance between the soldering pads must not be greater than the distance between the anode and cathode electrodes of the LEDs.
- * The design of this LED requires ensuring that an adequate area of each electrode is soldered to a corresponding soldering pad. Nichia recommends 75% coverage to guarantee the reliability of the LEDs. Since this LED is very compact, the area of its electrodes is very small; to ensure that there are no issues with the customized soldering pad pattern, sufficient verification should be performed before using it in the chosen application.
- * When flux is used, it should be a halogen free flux. Ensure that the manufacturing process is not designed in a manner where the flux will come in contact with the LEDs.
- * Ensure that there are no issues with the type and amount of solder that is being used.
- * This LED has all the electrodes on the backside; solder connections will not be able to be seen nor confirmed by a normal visual inspection. Ensure that sufficient verification is performed on the soldering conditions prior to use to ensure that there are no issues.

TAPE AND REEL DIMENSIONS

テーピング部 Tape

Part No. NxxxL11x
No. STS-DA7-20384
(単位 Unit: mm)

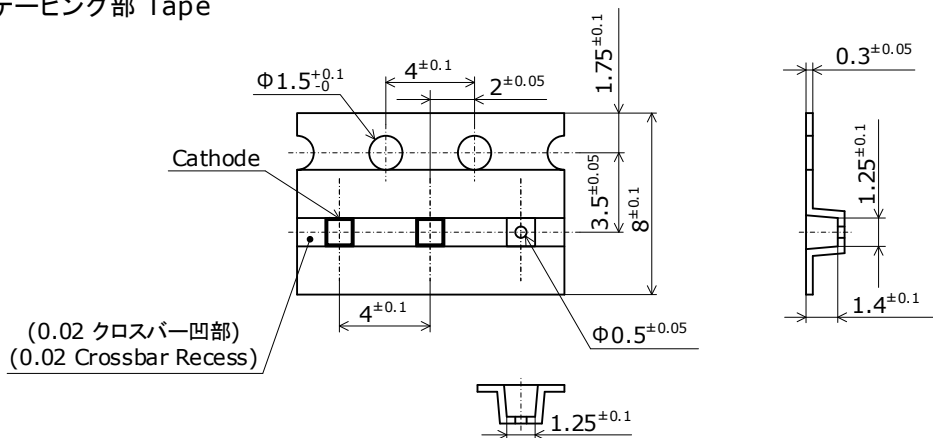

トレーラ部/リーダ部 Trailer and Leader

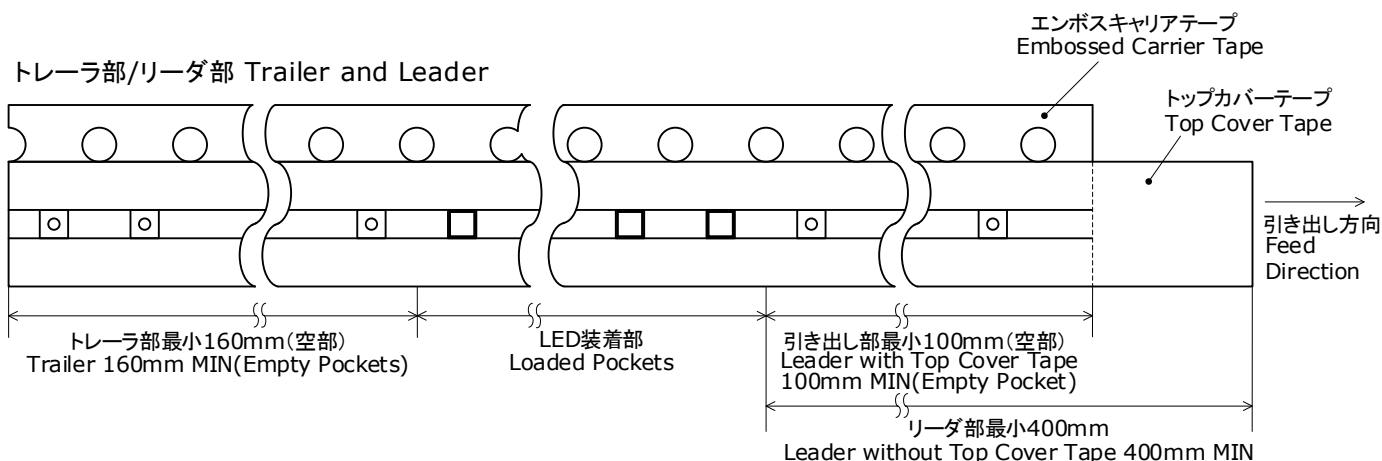

リール部 Reel

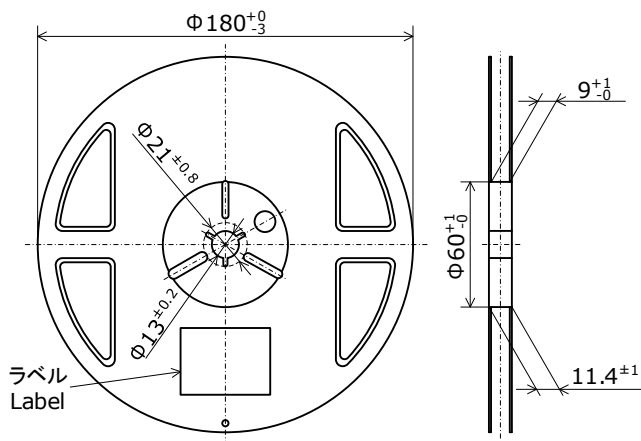

- * 数量は1リールにつき 3000個入りです。
Reel Size: 3000pcs
- * 実装作業の中断などでエンボスキャリアテープをリールに巻き取る場合、エンボスキャリアテープを強く(10N以上)締めないで下さい。
LEDがカバーテープに貼り付く可能性があります。
When the tape is rewound due to work interruptions, no more than 10N should be applied to the embossed carrier tape.
The LEDs may stick to the top cover tape.
- * JIS C 0806電子部品テーピングに準拠しています。
The tape packing method complies with JIS C 0806 (Packaging of Electronic Components on Continuous Tapes).

PACKAGING - TAPE & REEL

Reels are shipped with desiccants in heat-sealed moisture-proof bags.
シリカゲルとともにリールをアルミ防湿袋に入れ、熱シールにより封をします。

Part No. Nxxxxxxx
No. STS-DA7-4989C

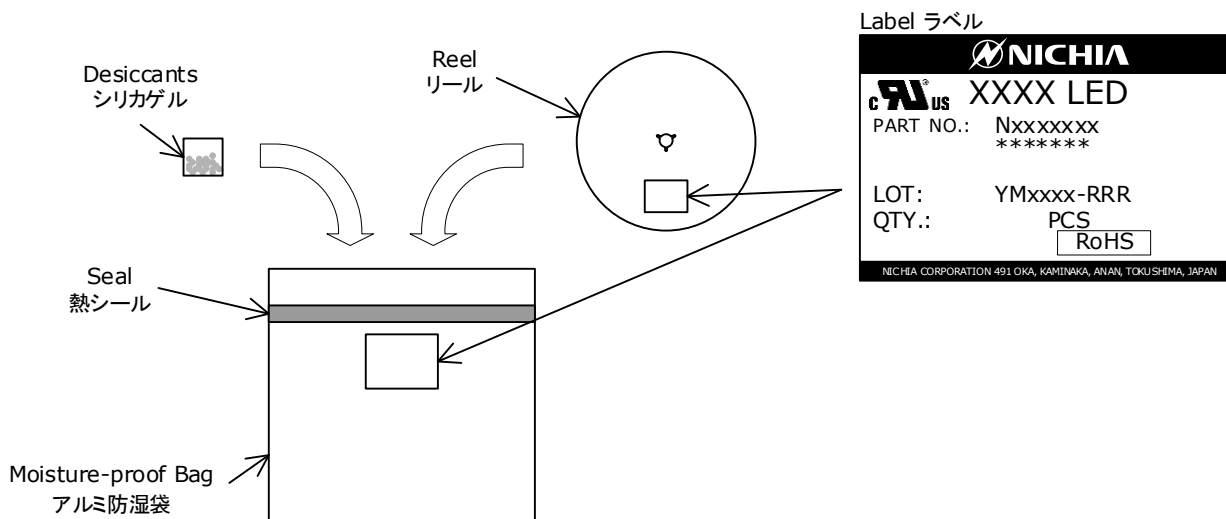

Moisture-proof bags are packed in cardboard boxes with corrugated partitions.
アルミ防湿袋を並べて入れ、ダンボールで仕切ります。

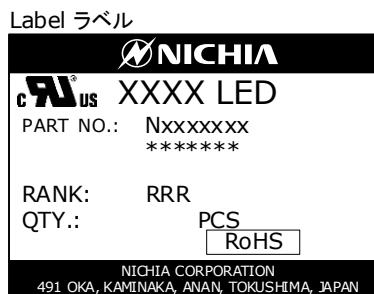
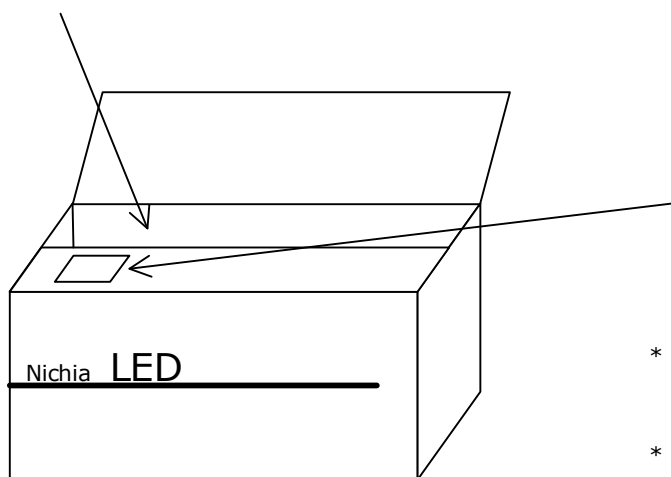

- * ***** is the customer part number. If not provided, it will not be indicated on the label. 客先型名を*****で示します。客先型名が設定されていない場合は空白です。
- * For details, see "LOT NUMBERING CODE" in this document. ロット表記方法についてはロット番号の項を参照して下さい。
- * The label does not have the RANK field for un-ranked products. ランク分けがない場合はランク表記はありません。

- * Products shipped on tape and reel are packed in a moisture-proof bag. They are shipped in cardboard boxes to protect them from external forces during transportation. 本製品はテーピングしたのち、輸送の衝撃から保護するためダンボールで梱包します。
- * Do not drop or expose the box to external forces as it may damage the products. 取り扱いに際して、落下させたり、強い衝撃を与えたりしますと、製品を損傷させる原因になりますので注意して下さい。
- * Do not expose to water. The box is not water-resistant. ダンボールには防水加工がされておりませんので、梱包箱が水に濡れないよう注意して下さい。
- * Using the original package material or equivalent in transit is recommended. 輸送、運搬に際して弊社よりの梱包状態あるいは同等の梱包を行って下さい。

LOT NUMBERING CODE

Lot Number is presented by using the following alphanumeric code.

YMxxxx - RRR

Y - Year

| Year | Y |
|------|---|
| 2022 | M |
| 2023 | N |
| 2024 | O |
| 2025 | P |
| 2026 | Q |
| 2027 | R |

M - Month

| Month | M | Month | M |
|-------|---|-------|---|
| 1 | 1 | 7 | 7 |
| 2 | 2 | 8 | 8 |
| 3 | 3 | 9 | 9 |
| 4 | 4 | 10 | A |
| 5 | 5 | 11 | B |
| 6 | 6 | 12 | C |

xxxx-Nichia's Product Number

RRR-Ranking by Color Coordinates, Ranking by Luminous Flux, Ranking by Forward Voltage, Ranking by Color Rendering Index

DERATING CHARACTERISTICS

Part No. NFSWL11A-D6
No. STS-DA7-20377A

Ambient Temperature vs Allowable Forward Current
周囲温度-許容順電流特性

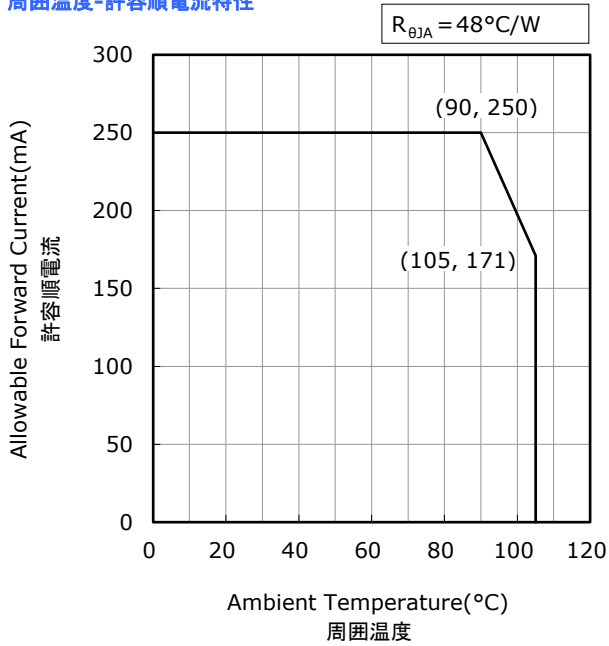

Temperature at Measurement Point on a Case vs Allowable Forward Current
ケース温度測定部温度-許容順電流特性

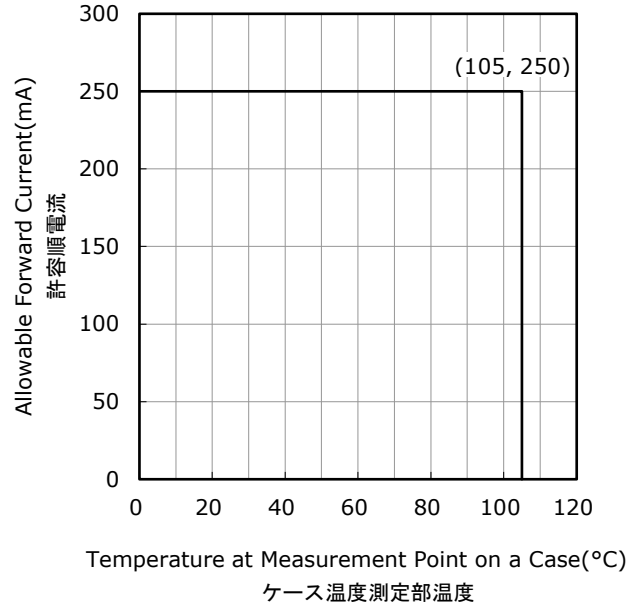

Duty Ratio vs Allowable Forward Current
デューティー比-許容順電流特性

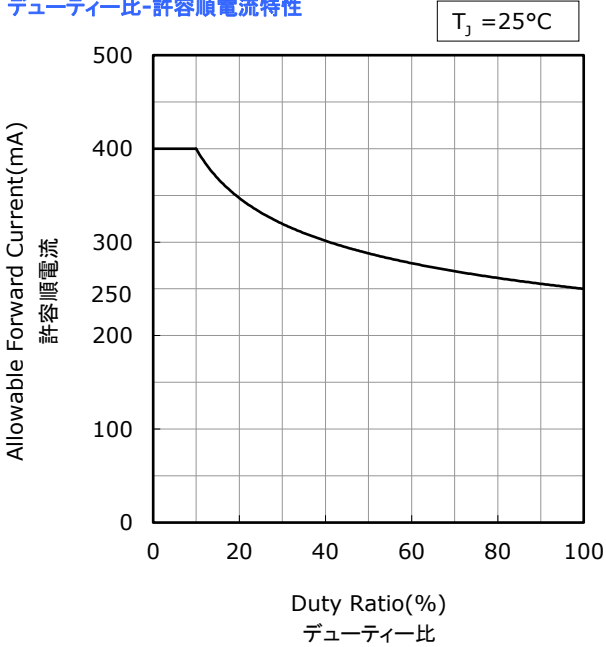

OPTICAL CHARACTERISTICS

- * All characteristics shown are for reference only and are not guaranteed.
本特性は参考です。
- * The following graphs show the characteristics measured in pulse mode.
パルス駆動により測定しています。

Part No. NFSWL11A-D6
No. STS-DA7-20378A

Spectrum 発光スペクトル

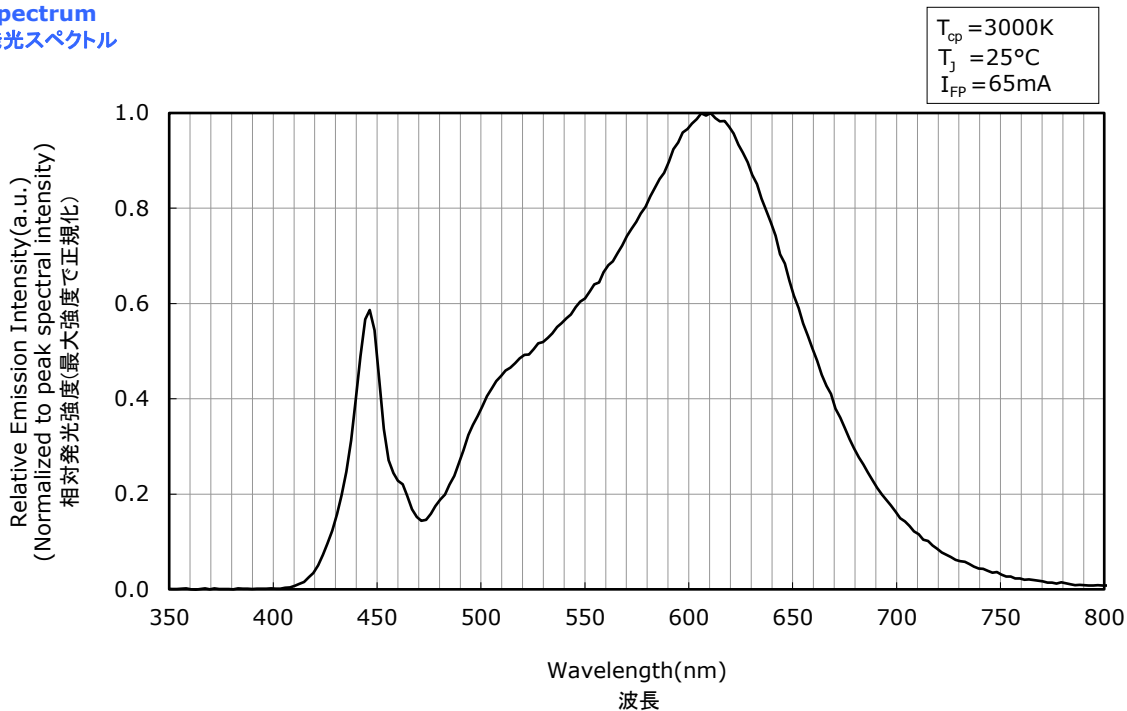

Directivity 指向特性

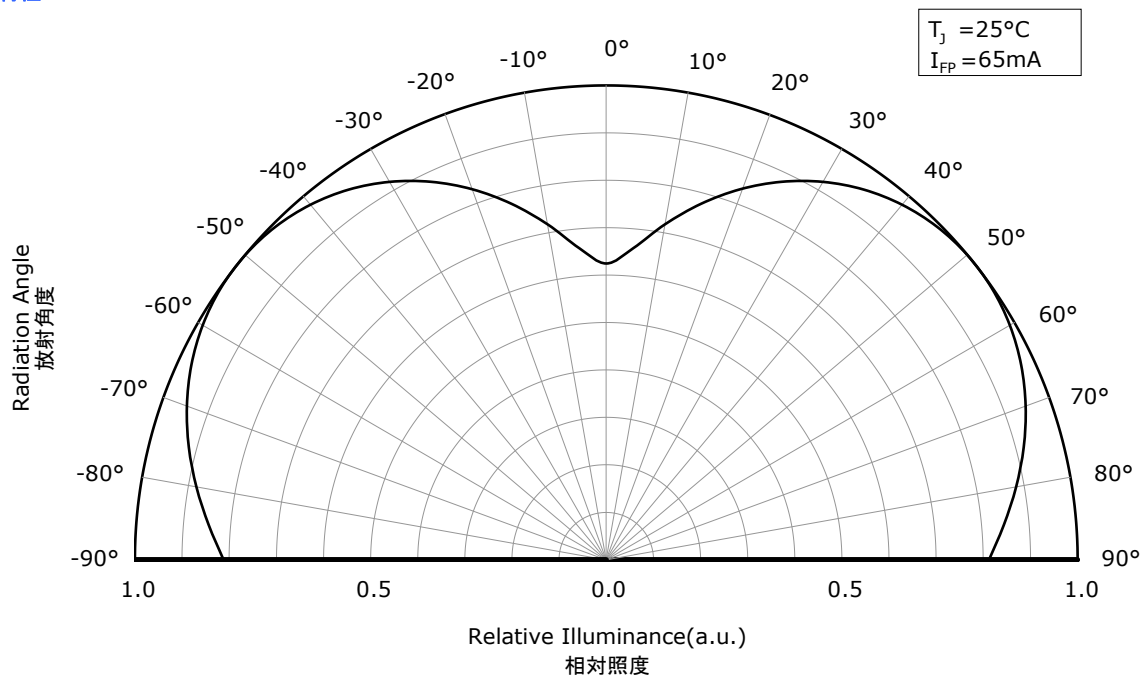

- * The graphs above show the characteristics for R8000 LEDs of this product.
本特性は演色性ランクR8000に対応しています。

OPTICAL CHARACTERISTICS

- * All characteristics shown are for reference only and are not guaranteed.
本特性は参考です。
- * The following graphs show the characteristics measured in pulse mode.
パルス駆動により測定しています。

Part No. NFSWL11A-D6
No. STS-DA7-20379A

Spectrum 発光スペクトル

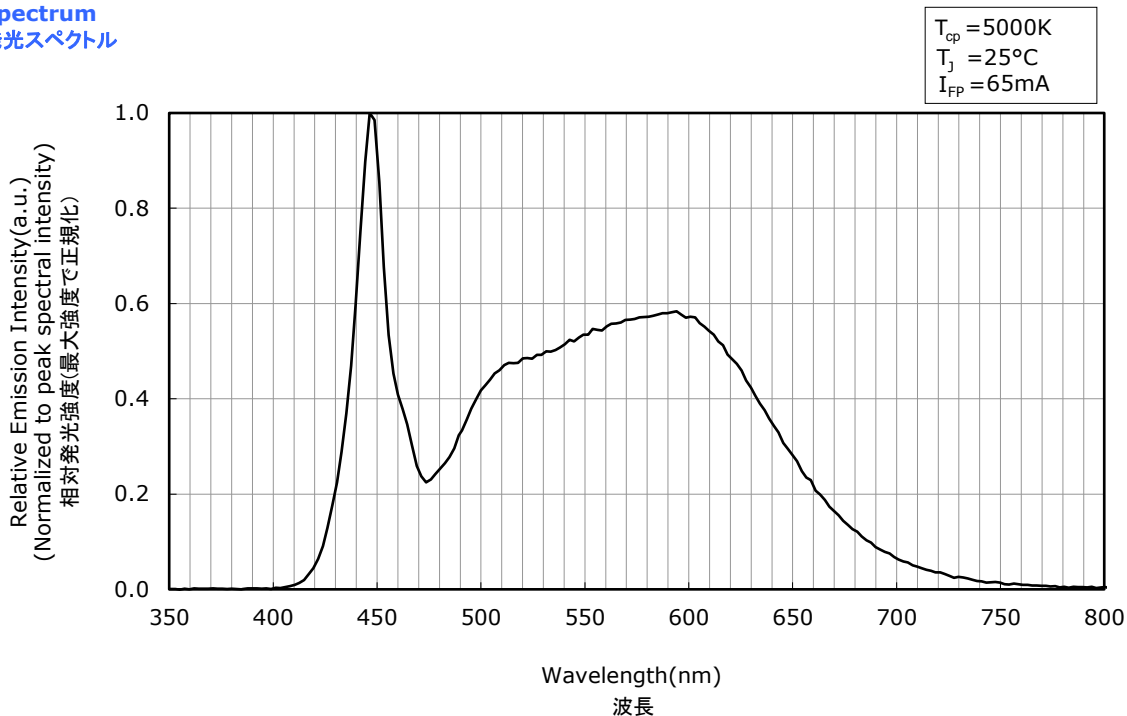

Directivity 指向特性

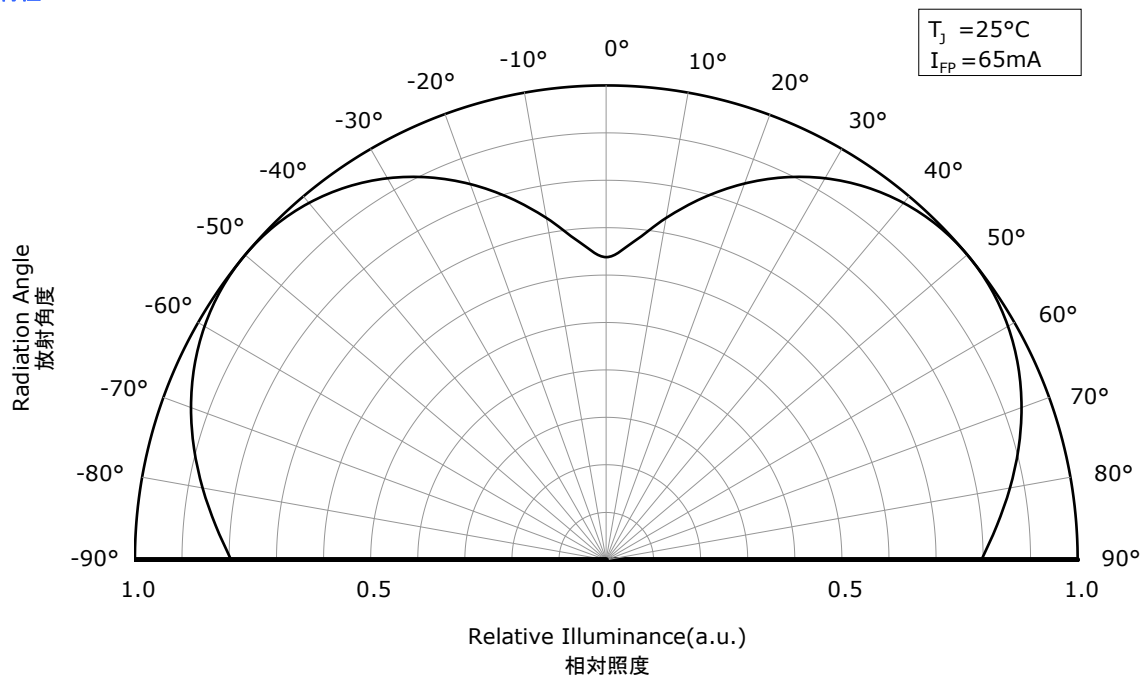

- * The graphs above show the characteristics for R8000 LEDs of this product.
本特性は演色性ランクR8000に対応しています。

FORWARD CURRENT CHARACTERISTICS / TEMPERATURE CHARACTERISTICS

- * All characteristics shown are for reference only and are not guaranteed.
本特性は参考です。
- * The following graphs show the characteristics measured in pulse mode.
パルス駆動により測定しています。

Part No. NFSWL11A-D6
No. STS-DA7-20380A

Forward Voltage vs Forward Current
順電圧-順電流特性

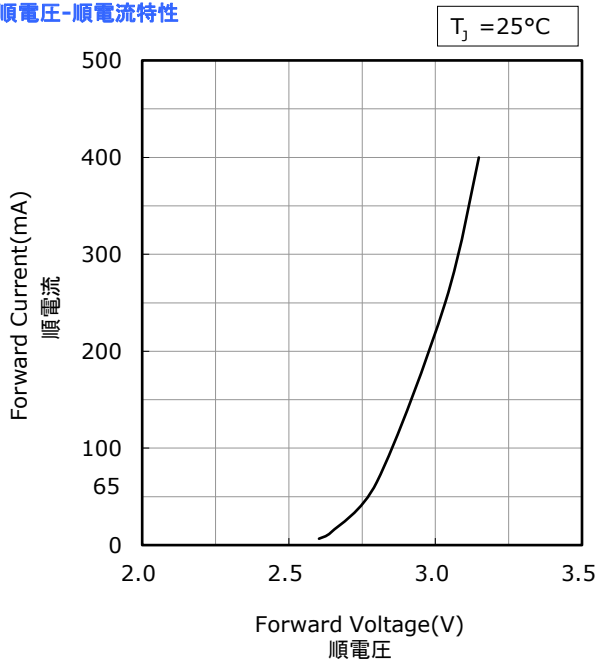

Junction Temperature vs Forward Voltage
ジャンクション温度-順電圧特性

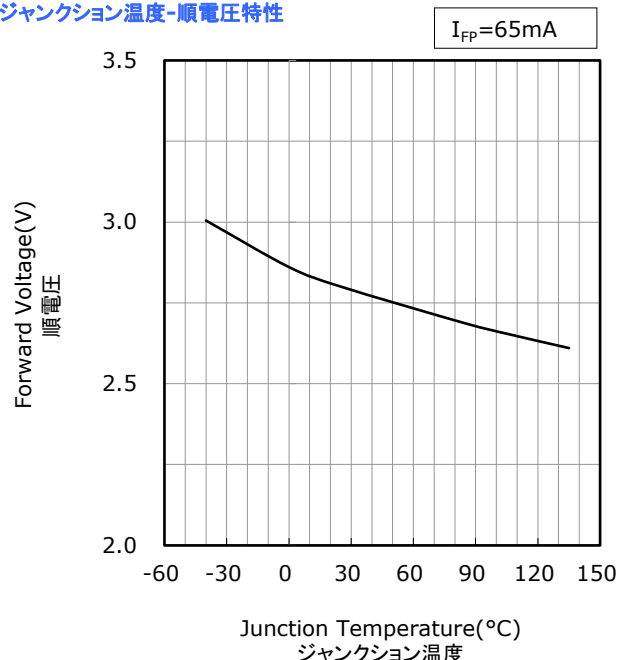

Forward Current vs Relative Luminous Flux
順電流-相対光束特性

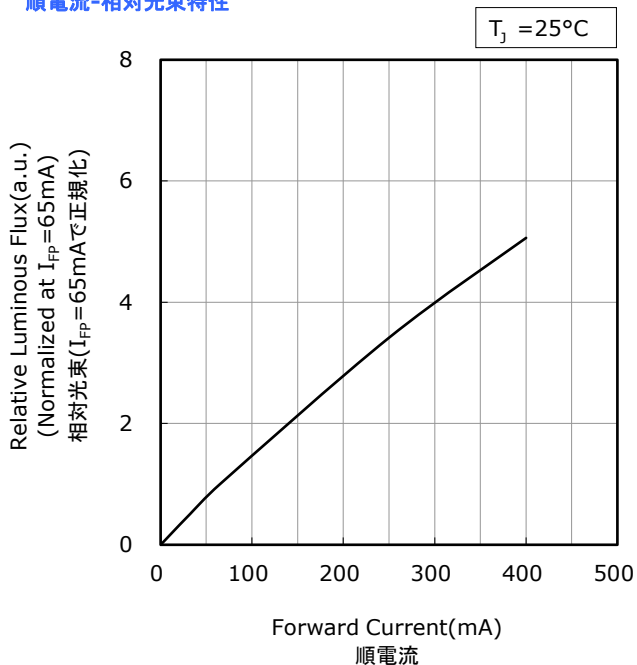

Junction Temperature vs Relative Luminous Flux
ジャンクション温度-相対光束特性

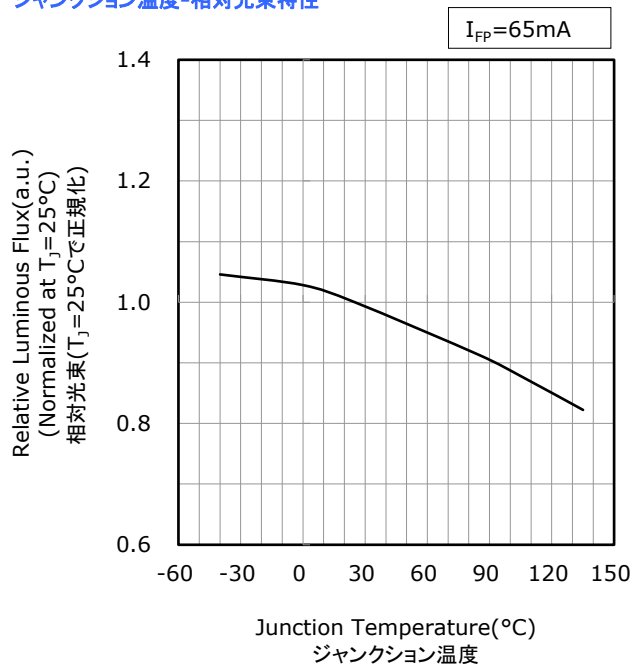

- * The graphs above show the characteristics for 2700K~4500K, R8000 LEDs of this product.
本特性は色温度2700K~4500K、演色性ランクR8000に対応しています。

FORWARD CURRENT CHARACTERISTICS / TEMPERATURE CHARACTERISTICS

- * All characteristics shown are for reference only and are not guaranteed.
本特性は参考です。
- * The following graphs show the characteristics measured in pulse mode.
パルス駆動により測定しています。

Part No. NFSWL11A-D6
No. STS-DA7-20381A

Forward Voltage vs Forward Current
順電圧-順電流特性

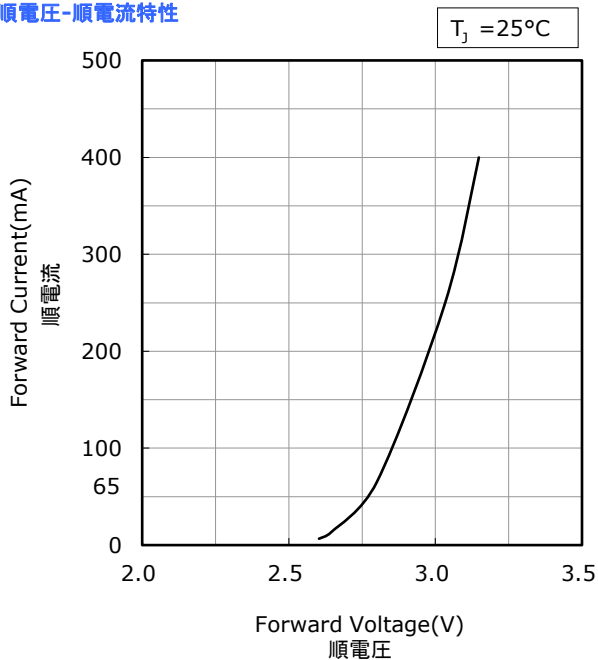

Junction Temperature vs Forward Voltage
ジャンクション温度-順電圧特性

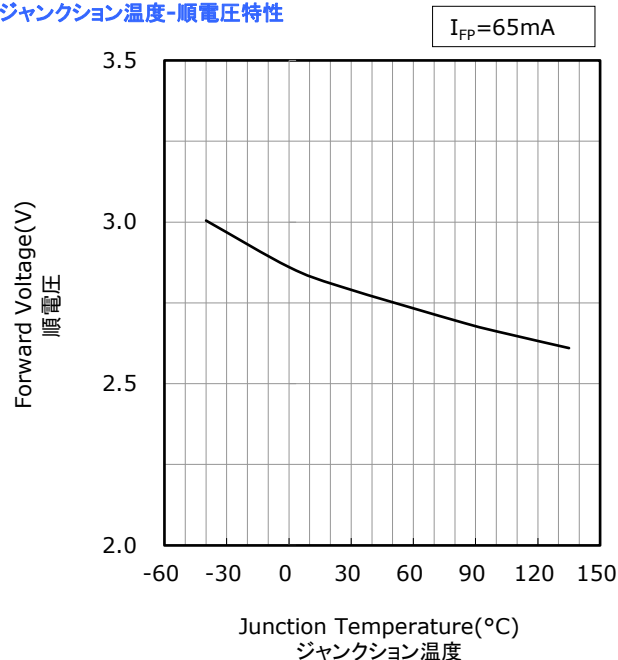

Forward Current vs Relative Luminous Flux
順電流-相対光束特性

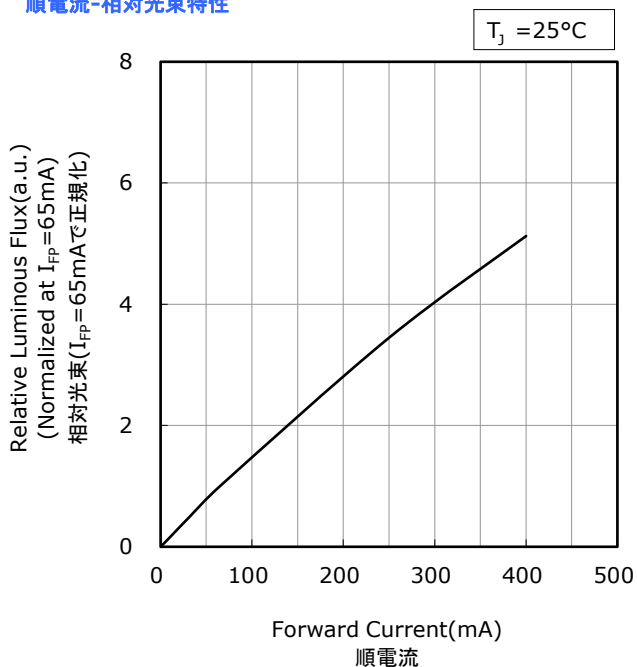

Junction Temperature vs Relative Luminous Flux
ジャンクション温度-相対光束特性

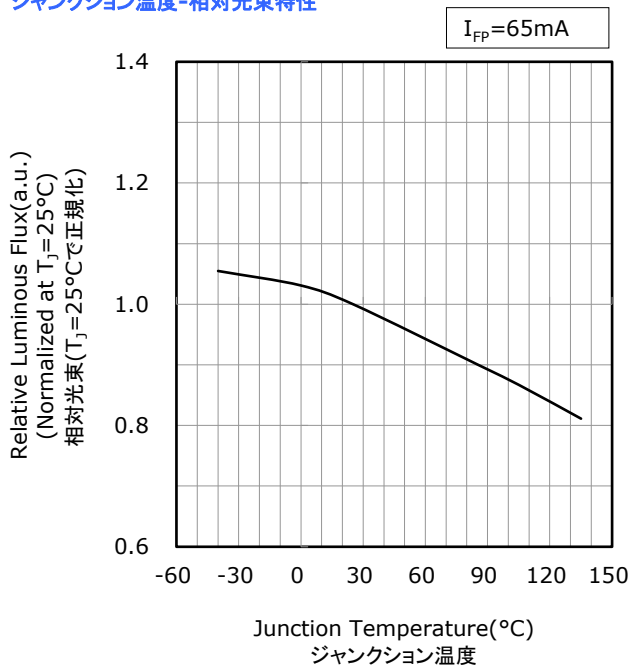

- * The graphs above show the characteristics for 5000K~6500K, R8000 LEDs of this product.
本特性は色温度5000K~6500K、演色性ランクR8000に対応しています。

FORWARD CURRENT CHARACTERISTICS / TEMPERATURE CHARACTERISTICS

- * All characteristics shown are for reference only and are not guaranteed.
本特性は参考です。
- * The following graphs show the characteristics measured in pulse mode.
パルス駆動により測定しています。

Part No. NFSWL11A-D6
No. STS-DA7-20382A

Forward Current vs Chromaticity Coordinate
順電流-色度 特性

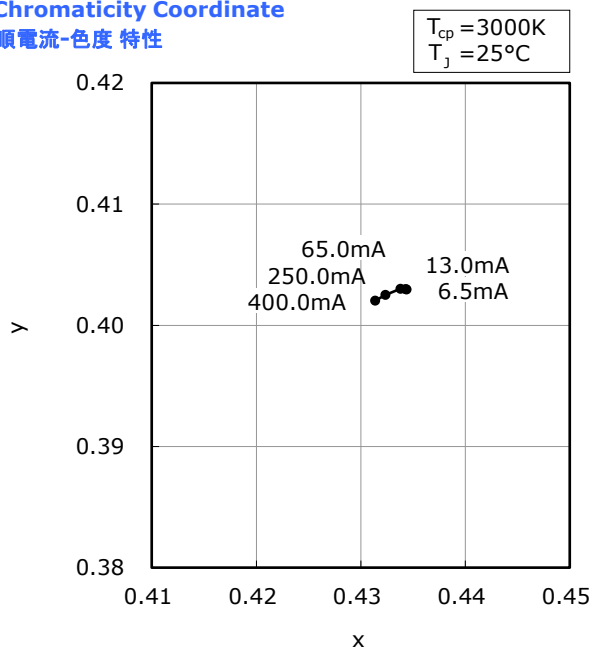

Junction Temperature vs Chromaticity Coordinate
ジャンクション温度-色度 特性

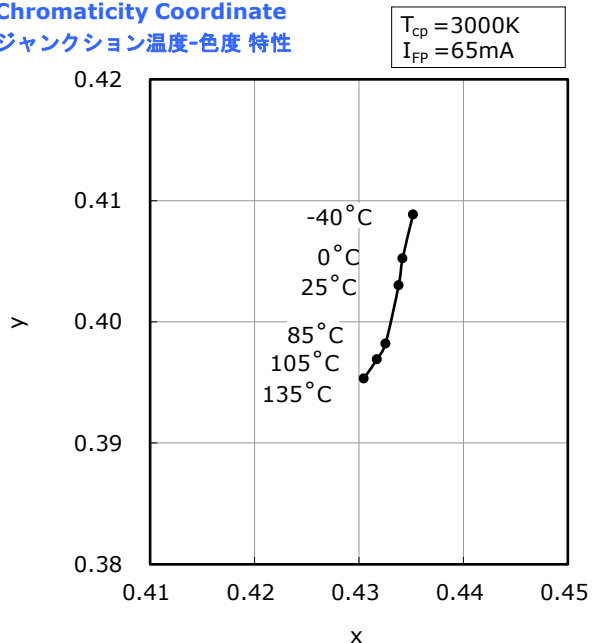

- * The graphs above show the characteristics for R8000 LEDs of this product.
本特性は演色性ランクR8000に対応しています。

FORWARD CURRENT CHARACTERISTICS / TEMPERATURE CHARACTERISTICS

- * All characteristics shown are for reference only and are not guaranteed.
本特性は参考です。
- * The following graphs show the characteristics measured in pulse mode.
パルス駆動により測定しています。

Part No. NFSWL11A-D6
No. STS-DA7-20383A

Forward Current vs Chromaticity Coordinate
順電流-色度 特性

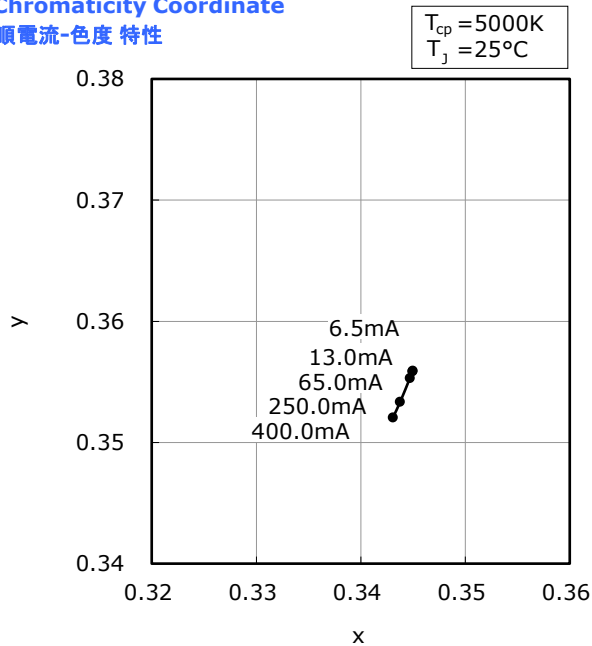

Junction Temperature vs Chromaticity Coordinate
ジャンクション温度-色度 特性

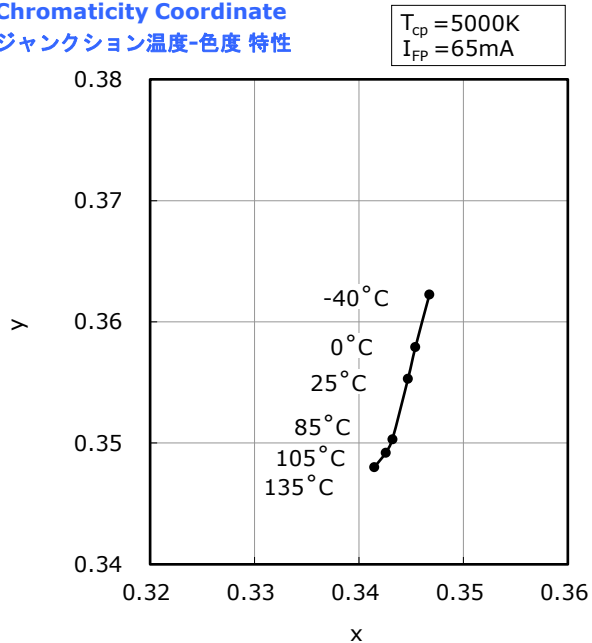

- * The graphs above show the characteristics for R8000 LEDs of this product.
本特性は演色性ランクR8000に対応しています。

RELIABILITY

(1) Tests and Results

| Test | Reference Standard | Test Conditions | Test Duration | Failure Criteria # | Units Failed/Tested |
|---|------------------------|---|---------------|--------------------|---------------------|
| Resistance to Soldering Heat (Reflow Soldering) | JEITA ED-4701 300 301 | $T_{\text{slid}}=260^{\circ}\text{C}$, 10sec, 2reflows, Precondition: 30°C , 70%RH, 4weeks | | #1 | 0/22 |
| Solderability | JEITA ED-4701 303 303A | $T_{\text{slid}}=245\pm 5^{\circ}\text{C}$, 5sec, Lead-free Solder(Sn-3.0Ag-0.5Cu) | | #2 | 0/22 |
| Thermal Shock(Air to Air) | | -40°C to 110°C , 15min dwell | 100cycles | #1 | 0/22 |
| Moisture Resistance (Cyclic) | JEITA ED-4701 200 203 | $25^{\circ}\text{C}\sim 65^{\circ}\text{C}\sim -10^{\circ}\text{C}$, 90%RH, 24hr per cycle | 10cycles | #1 | 0/22 |
| High Temperature Storage | JEITA ED-4701 200 201 | $T_{\text{A}}=110^{\circ}\text{C}$ | 1000hours | #1 | 0/22 |
| Temperature Humidity Storage | JEITA ED-4701 100 103 | $T_{\text{A}}=60^{\circ}\text{C}$, RH=90% | 1000hours | #1 | 0/22 |
| Low Temperature Storage | JEITA ED-4701 200 202 | $T_{\text{A}}=-40^{\circ}\text{C}$ | 1000hours | #1 | 0/22 |
| Room Temperature Operating Life | | $T_{\text{A}}=25^{\circ}\text{C}$, $I_{\text{F}}=250\text{mA}$ Test board: See NOTES below | 1000hours | #1 | 0/22 |
| High Temperature Operating Life | | $T_{\text{A}}=100^{\circ}\text{C}$, $I_{\text{F}}=190\text{mA}$ Test board: See NOTES below | 1000hours | #1 | 0/22 |
| Temperature Humidity Operating Life | | 60°C , RH=90%, $I_{\text{F}}=250\text{mA}$ Test board: See NOTES below | 500hours | #1 | 0/22 |
| Low Temperature Operating Life | | $T_{\text{A}}=-40^{\circ}\text{C}$, $I_{\text{F}}=250\text{mA}$ Test board: See NOTES below | 1000hours | #1 | 0/22 |
| Vibration | JEITA ED-4701 400 403 | 200m/s^2 , $100\sim 2000\sim 100\text{Hz}$, 4cycles, 4min, each X, Y, Z | 48minutes | #1 | 0/22 |
| Free Fall | | 3drops from a height of 75cm | | #1 | 0/22 |

NOTES:

- 1) Test board: FR4 board thickness=1.6mm, copper layer thickness=35 μm , $R_{\theta\text{JA}}\approx 48^{\circ}\text{C/W}$
- 2) Measurements are performed after allowing the LEDs to return to room temperature.

(2) Failure Criteria

| Criteria # | Items | Conditions | Failure Criteria |
|------------|------------------------------------|----------------------------|-------------------------------|
| #1 | Forward Voltage(V_{F}) | $I_{\text{F}}=65\text{mA}$ | $> \text{U.S.L.} \times 1.1$ |
| | Luminous Flux(Φ_{v}) | $I_{\text{F}}=65\text{mA}$ | $< \text{L.S.L.} \times 0.7$ |
| | Reverse Current(I_{R}) | $V_{\text{R}}=5\text{V}$ | $> \text{U.S.L.} \times 2.0$ |
| #2 | Solderability | - | Less than 95% solder coverage |

U.S.L. : Upper Specification Limit L.S.L. : Lower Specification Limit

CAUTIONS

(1) Storage

| Conditions | | Temperature | Humidity | Time |
|------------|-----------------------------|-------------|----------|----------------------------------|
| Storage | Before Opening Aluminum Bag | ≤30°C | ≤90%RH | Within 1 Year from Delivery Date |
| | After Opening Aluminum Bag | ≤30°C | ≤70%RH | ≤4weeks |

- The storage/packaging requirements for this LED are comparable to JEDEC Moisture Sensitivity Level (MSL) 2a or equivalent. Nichia used IPC/JEDEC STD-020 as a reference to rate the MSL of this LED.
- Ensure that soldering is completed within the storage times detailed above.
- This LED uses a package that could absorb moisture; if the package absorbs moisture and is exposed to heat during soldering, it may cause the moisture to vaporize and the package to expand and the resulting pressure may cause internal delamination. This may cause the optical characteristics to degrade. To minimize moisture absorption in storage/transit, moisture-proof aluminum bags are used for the LEDs with a silica gel packet to absorb any air moisture in the bag. The silica gel beads turn blue to red as they absorb moisture.
- Once the moisture-proof aluminum bag is open, ensure that the LED is soldered to a PCB within the range of the conditions above. To store any remaining unused LEDs, use a hermetically sealed container with silica gel desiccants. Nichia recommends placing them back to the original moisture-proof bag and reseal it.
- The parts/materials (e.g. housing, gasket/seal, secondary lens, lens cover, thermal grease, etc.) used with the LED in the same assembly/system may release corrosive gases containing sulfur, halogens, etc. A light-up test, sufficient verifications, etc. must be performed at the finished product level (i.e. automotive headlamp, luminaire, etc.) prior to use taking into consideration the conditions/environments in which the finished product will actually be used to ensure that the expected performance for the finished product is maintained. See below for the detailed information.

Issues that may be caused by corrosive gases containing sulfur, halogens, etc.:

This LED has plated parts. If the LED is exposed to corrosive gases containing sulfur, halogens, etc., it may cause the plated surface to tarnish. If the gases penetrate the LED (e.g. emitting surface, package material, etc.), it may cause the surface of the plated parts inside the package to tarnish. In addition, it has been confirmed that if a silicone resin is used in the LED, the gases may accelerate degradation of the silicone resin. As a result, the optical characteristics may be adversely affected (i.e. significant reduction in the brightness, significant color shift, etc.); in the worst case, the circuit could become open causing a catastrophic failure (i.e. the LED not to illuminate). When determining the storage environment for the LED and/or selecting parts/materials that will be used with the LED in the finished product, it must be ensured prior to use that corrosive gases containing sulfur, halogens, etc. are not generated.

- To avoid condensation, the LEDs must not be stored in areas where temperature and humidity fluctuate greatly.
- Do not store the LEDs in a dusty environment.
- Do not expose the LEDs to direct sunlight and/or an environment over a long period of time where the temperature is higher than normal room temperature.

(2) Directions for Use

- The circuit must be designed to ensure that the Absolute Maximum Ratings are not exceeded for each LED. The LEDs should be operated at a constant current per LED. In the case of operating at a constant voltage, Circuit B is recommended. If Circuit A is used, it may cause the currents flowing through the LEDs to vary due to the variation in the forward voltage characteristics of the LEDs on the circuit.

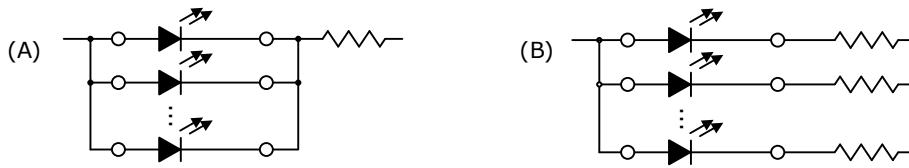

- This LED is designed to be operated at a forward current. Ensure that no voltage is applied to the LED in the forward/reverse direction while the LED is off. If the LEDs are used in an environment where reverse voltages are applied to the LED continuously, it may cause electrochemical migration to occur causing the LED to be damaged. When not in use for a long period of time, the system's power should be turned off to ensure that there are no issues/damage.
- To stabilize the LED characteristics while in use, Nichia recommends that the LEDs are operated at currents $\geq 10\%$ of the sorting current.
- If LEDs are arranged into rows and columns in a grid circuit (i.e. LED matrix circuit) and operated, ensure that when using a pulsed mode to operate the LEDs in a matrix circuit, the reverse voltage for any of the LEDs does not exceed the Absolute Maximum Rating while the LED is off.
- Ensure that transient excessive voltages (e.g. lightning surge) are not applied to the LEDs.
- If the LEDs are used for outdoor applications, ensure that necessary measures are taken (e.g. protecting the LEDs from water/salt damage and high humidity).

(3) Handling Precautions

- Do not handle the LEDs with bare hands. This may contaminate the LED surface and have an effect on the optical characteristics and/or cause the LED to deform causing a catastrophic failure (i.e. the LED not to illuminate).
- The resin of this LED is very soft. The surface of the resin may be damaged (e.g. cut, scratch, chip, crack, delamination, and deformation) when it is touched while the LED is being handled. Also, if force is applied to the resin, it may cause a catastrophic failure; ensure that when handling the LED with tweezers, excessive force is not applied to the LED.
- Dropping may cause damage to the LED (e.g. deformation).
- Do not stack assembled PCBs together. Otherwise, it may cause damage to the resin (e.g. cut, scratch, chip, crack, delamination, and deformation) causing a catastrophic failure or the LEDs to be removed from the PCB.

(4) Design Consideration

- If the LEDs are soldered to a PCB and the PCB assembly is bent (e.g. PCB depaneling process), it may cause the LED package to break. The PCB layout should be designed to minimize the mechanical stress on the LEDs when the PCB assembly is bent/warped.
- The amount of mechanical stress exerted on the LED from depaneling may vary depending on the LED position/orientation on the PCB assembly (e.g. especially in areas near V-groove scores). The PCB layout should be designed to minimize the mechanical stress on the LEDs when the PCB is separated into individual PCB assemblies.
- To separate a PCB populated with the LEDs, use a specially designed tool. Do not break the PCB by hand.
- The parts/materials (e.g. housing, gasket/seal, secondary lens, lens cover, thermal grease, etc.) used with the LED in the same assembly/system may release corrosive gases containing sulfur, halogens, etc., and/or volatile organic compounds (VOCs). A light-up test, sufficient verifications, etc. must be performed at the finished product level (i.e. automotive headlamp, luminaire, etc.) prior to use taking into consideration the conditions/environments in which the finished product will actually be used to ensure that the expected performance for the finished product is maintained. See below for the detailed information.

Issues that may be caused by corrosive gases containing sulfur, halogens, etc.:

This LED has plated parts. If the LED is exposed to corrosive gases containing sulfur, halogens, etc., it may cause the plated surface to tarnish. If the gases penetrate the LED (e.g. emitting surface, package material, etc.), it may cause the surface of the plated parts inside the package to tarnish. In addition, it has been confirmed that if a silicone resin is used in the LED, the gases may accelerate degradation of the silicone resin. As a result, the optical characteristics may be adversely affected (i.e. significant reduction in the brightness, significant color shift, etc.); in the worst case, the circuit could become open causing a catastrophic failure (i.e. the LED not to illuminate). When determining the storage environment for the LED and/or selecting parts/materials that will be used with the LED in the finished product, it must be ensured prior to use that corrosive gases containing sulfur, halogens, etc. are not generated.

Issues that may be caused by VOCs:

If VOCs that have been released from the parts/materials and/or organic additives used with the LED in the finished product penetrate into the LED and remain inside the LED, the VOCs can discolor after being exposed to heat and/or photon energy. This may cause the optical characteristics to be adversely affected (i.e. significant reduction in the brightness, significant color shift, etc.). This adverse effect may be improved by ventilating the environment (i.e. the LED is not used in a hermetically sealed environment) to prevent the VOCs from remaining inside the LED. When selecting parts/materials that will be used with the LED in the finished product, it must be ensured prior to use that there are no issues with the substances found in those parts/materials and/or that the expected performance for the finished product is maintained by performing a light-up test, sufficient verifications etc. taking into consideration the conditions/environments in which the finished product will actually be used.

- The characteristics of the LEDs (e.g. chromaticity, color rendering index, etc.) will vary depending on how the LEDs are designed into the application (e.g. secondary lens, luminaire cover/housing, etc. for ease of dissipation), how they were assembled, under what conditions/environments they are used (e.g. operating current/temperature, etc.), and how long they have been used (e.g. storage/operating hours, etc.). To ensure that there are no issues (e.g. deviations/changes in the characteristics, etc.) with the chosen application, perform a sufficient verification prior to use.
- Light emitted from the LED may cause the solder resist on the chosen PCB to be discolored, cracked, etc.; take this into consideration when selecting a PCB and solder resist.

(5) Electrostatic Discharge (ESD)

- This LED is sensitive to transient excessive voltages (e.g. ESD, lightning surge). If this excessive voltage occurs in the circuit, it may cause the LED to be damaged causing issues (e.g. the LED to become dimmer or not to illuminate [i.e. catastrophic failure]). Ensure that when handling the LEDs, necessary measures are taken to protect them from an ESD discharge. The following examples are recommended measures to eliminate the charge:
 - Grounded wrist strap, ESD footwear, clothes, and floors
 - Grounded workstation equipment and tools
 - ESD table/shelf mat made of conductive materials
- Ensure that all necessary measures are taken to prevent the LEDs from being exposed to transient excessive voltages (e.g. ESD, lightning surge):
 - tools, jigs, and machines that are used are properly grounded
 - appropriate ESD materials/equipment are used in the work area
 - the system/assembly is designed to provide ESD protection for the LEDs
- If the tool/equipment used is an insulator (e.g. glass cover, plastic, etc.), ensure that necessary measures have been taken to protect the LED from transient excessive voltages (e.g. ESD). The following examples are recommended measures to eliminate the charge:
 - Dissipating static charge with conductive materials
 - Preventing charge generation with moisture
 - Neutralizing the charge with ionizers
- To detect if an LED was damaged by transient excess voltages (i.e. an ESD event during the system's assembly process), perform a characteristics inspection (e.g. forward voltage measurement, light-up test) at low current ($\leq 1\text{mA}$).
- Failure Criteria: $V_F < 2.0\text{V}$ at $I_F = 0.5\text{mA}$
 If any one or more dice, except for the red die, are damaged by transient excess voltages (e.g. ESD), it will cause:
 - the leakage current to increase
 - the Forward Voltage (V_F) to decrease
 - the LED not to illuminate at a low current

(6) Thermal Management

- The Absolute Maximum Junction Temperature (T_J) must not be exceeded under any circumstances. The increase in the temperature of an LED while in operation may vary depending on the PCB thermal resistance and the density of LEDs on the PCB assembly. Ensure that when using the LEDs for the chosen application, heat is not concentrated in an area and properly managed in the system/assembly.
- The temperature of the emitting surface increases while in operation; if it becomes too high, degradation of the package materials and/or the parts/materials used with the LED may be accelerated.
- When measuring the temperatures of the LEDs for the thermal management design, a non-contact temperature measuring instrument (e.g. thermal imaging camera) should be used.
- The operating current should be determined by considering the temperature conditions surrounding the LED (i.e. T_A). Ensure that when operating the LED, proper measures are taken to dissipate the heat.
- The following two equations can be used to calculate the LED junction temperature:

$$1) T_J = T_A + R_{\theta JA} \cdot W \quad 2) T_J = T_C + R_{\theta JC} \cdot W$$

* T_J = LED Junction Temperature: °C

T_A = Ambient Temperature: °C

T_C = Case Temperature: °C

$R_{\theta JA}$ = Thermal Resistance from Junction to Ambient: °C/W

$R_{\theta JC}$ = Thermal Resistance from Junction to T_C Measurement Point: °C/W

W = Input Power ($I_F \times V_F$): W

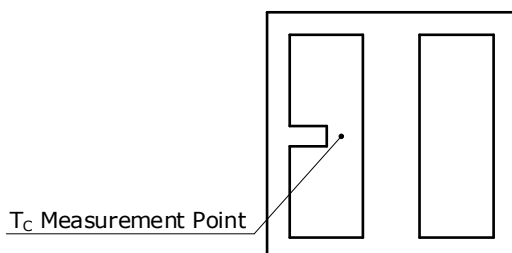

(7) Cleaning

- Do not clean the LEDs with water, benzine and/or thinner.
- To clean the LEDs, use isopropyl alcohol (IPA). If another solvent is used, it may cause the LED package/resin to be damaged causing issues; ensure that sufficient verification is performed prior to use. Additionally, ensure that the solvent being used does not cause any other issues (e.g. CFC-based solvents are heavily regulated).
- If an LED is contaminated (e.g. dust/dirt), use a cloth soaked with isopropyl alcohol (IPA). Ensure that the cloth is firmly squeezed before wiping the LED.
- Do not clean the LEDs with an ultrasonic cleaner. If cleaning must be done, ensure that sufficient verification is performed by using a finished assembly with LEDs to determine cleaning conditions (e.g. ultrasonic power, LED position on the PCB assembly) that do not cause an issue.

(8) Eye Safety

- There may be two important international specifications that should be noted for safe use of the LEDs: IEC 62471:2006 Photobiological safety of lamps and lamp systems and IEC 60825-1:2001 (i.e. Edition 1.2) Safety of Laser Products - Part 1: Equipment Classification and Requirements. Ensure that when using the LEDs, there are no issues with the following points:
 - LEDs have been removed from the scope of IEC 60825-1 since IEC 60825-1:2007 (i.e. Edition 2.0) was published. However, depending on the country/region, there are cases where the requirements of the IEC 60825-1:2001 specifications or equivalent must be adhered to.
 - LEDs have been included in the scope of IEC 62471:2006 since the release of the specification in 2006.
 - Most Nichia LEDs will be classified as the Exempt Group or Risk Group 1 according to IEC 62471:2006. However, in the case of high-power LEDs containing blue wavelengths in the emission spectrum, there are LEDs that will be classified as Risk Group 2 depending on the characteristics (e.g. radiation flux, emission spectrum, directivity, etc.)
 - If the LED is used in a manner that produces an increased output or with an optic to collimate the light from the LED, it may cause damage to the human eye.
- If an LED is operated in a manner that emits a flashing light, it may cause health issues (e.g. visual stimuli causing eye discomfort). The system should be designed to ensure that there are no harmful effects on the human body.

(9) Miscellaneous

- Nichia warrants that the discrete LEDs will meet the requirements/criteria as detailed in the Reliability section within this specification. If the LEDs are used under conditions/environments deviating from or inconsistent with those described in this specification, the resulting damage and/or injuries will not be covered by this warranty.
- Nichia warrants that the discrete LEDs manufactured and/or supplied by Nichia will meet the requirements/criteria as detailed in the Reliability section within this specification; it is the customer's responsibility to perform sufficient verification prior to use to ensure that the lifetime and other quality characteristics required for the intended use are met.
- The applicable warranty period is one year from the date that the LED is delivered. In the case of any incident that appears to be in breach of this warranty, the local Nichia sales representative should be notified to discuss instructions on how to proceed while ensuring that the LED in question is not disassembled or removed from the PCB if it has been attached to the PCB. If a breach of this warranty is proved, Nichia will provide the replacement for the non-conforming LED or an equivalent item at Nichia's discretion. FOREGOING ARE THE EXCLUSIVE REMEDIES AVAILABLE TO THE CUSTOMER IN RESPECT OF THE BREACH OF THE WARRANTY CONTAINED HEREIN, AND IN NO EVENT SHALL NICHIA BE RESPONSIBLE FOR ANY INDIRECT, INCIDENTAL OR CONSEQUENTIAL LOSSES AND/OR EXPENSES (INCLUDING LOSS OF PROFIT) THAT MAY BE SUFFERED BY THE CUSTOMER ARISING OUT OF A BREACH OF THE WARRANTY.
- NICHIA DISCLAIMS ALL OTHER WARRANTIES, EXPRESS OR IMPLIED, INCLUDING THE IMPLIED WARRANTIES OF MERCHANTABILITY AND FITNESS FOR A PARTICULAR PURPOSE.
- This LED is intended to be used for general lighting, household appliances, electronic devices (e.g. mobile communication devices); it is not designed or manufactured for use in applications that require safety critical functions (e.g. aircraft, automobiles, combustion equipment, life support systems, nuclear reactor control system, safety devices, spacecraft, submarine repeaters, traffic control equipment, trains, vessels, etc.). If the LEDs are planned to be used for these applications, unless otherwise detailed in the specification, Nichia will neither guarantee that the LED is fit for that purpose nor be responsible for any resulting property damage, injuries and/or loss of life/health. This LED does not comply with IATF 16949 and is not intended for automotive applications.
- The customer will not reverse engineer, disassemble or otherwise attempt to extract knowledge/design information from the LED.
- All copyrights and other intellectual property rights in this specification in any form are reserved by Nichia or the right holders who have granted Nichia permission to use the content. Without prior written permission from Nichia, no part of this specification may be reproduced in any form or by any means.
- Both the customer and Nichia will agree on the official specifications for the supplied LEDs before any programs are officially launched. Without this agreement in writing (i.e. Customer Specific Specification), changes to the content of this specification may occur without notice (e.g. changes to the foregoing specifications and appearance, discontinuation of the LEDs, etc.).