

NICHIA CORPORATION

SPECIFICATIONS FOR AMBER LED

PART NO. NCSAE17AT-V1

- Pb-free Reflow Soldering Application
- RoHS Compliant



SPECIFICATIONS

(1) Absolute Maximum Ratings

Item	Symbol	Absolute Maximum Rating	Unit
Forward Current	I_F	700	mA
Pulse Forward Current	I_{FP}	1000	mA
Reverse Voltage	V_R	5	V
Power Dissipation	P_D	2.36	W
Operating Temperature	T_{opr}	-40~100	°C
Storage Temperature	T_{stg}	-40~100	°C
Junction Temperature	T_J	135	°C

* Absolute Maximum Ratings at $T_J=25^\circ\text{C}$.

* I_{FP} conditions with pulse width $\leq 10\text{ms}$ and duty cycle $\leq 10\%$.

* For I_F and I_{FP} , see the "DERATING CHARACTERISTICS" of this specification.

(2) Initial Electrical/Optical Characteristics

Item	Symbol	Condition	Typ	Max	Unit	
Forward Voltage	V_F	$I_F=350\text{mA}$	2.95	-	V	
Reverse Current	I_R	$V_R=5\text{V}$	-	-	μA	
Luminous Flux	Φ_v	$I_F=350\text{mA}$	131	-	lm	
Chromaticity Coordinate	x	-	$I_F=350\text{mA}$	0.567	-	-
	y		$I_F=350\text{mA}$	0.419	-	
Thermal Resistance	$R_{\theta JC}$	-	0.5	1.0	°C/W	

* Characteristics at $T_J=25^\circ\text{C}$ and measured in pulse mode.

* Optical Characteristics as per CIE 127:2007 standard.

* Chromaticity Coordinates as per CIE 1931 Chromaticity Chart.

* $R_{\theta JC}$ is measured using the Dynamic Mode detailed in JESD51-1.

* The thermal resistance value ($R_{\theta JC}$) is used to perform logical analysis (e.g. computer-based thermal analysis simulation) and represents a thermal resistance between the die to the T_C measurement point (PCB used: Aluminum PCB $t=1.5\text{mm}$, Insulating layer $t=0.12\text{mm}$).

* For more details on thermal resistance, see CAUTIONS, (6) Thermal Management.

RANKS

Item	Rank	Condition	Min	Max	Unit
Forward Voltage	M1	$I_F=350\text{mA}$	3.0	3.2	V
	L2		2.8	3.0	
	L12		2.7	2.8	
Reverse Current	-	$V_R=5\text{V}$	-	50	μA
Luminous Flux	D121	$I_F=350\text{mA}$	121	141	lm

Color Rank($I_F=350\text{mA}$)

	Rank Lea			
x	0.5787	0.5398	0.5509	0.5926
y	0.4033	0.4422	0.4481	0.4074

- * Ranking at $T_J=25^\circ\text{C}$ and measured in pulse mode.
- * Forward Voltage Tolerance: $\pm 0.05\text{V}$
- * Luminous Flux Tolerance: $\pm 6\%$
- * Chromaticity Coordinate Tolerance: ± 0.006
- * LEDs from the above ranks will be shipped. The rank combination ratio per shipment will be decided by Nichia.

CHROMATICITY DIAGRAM

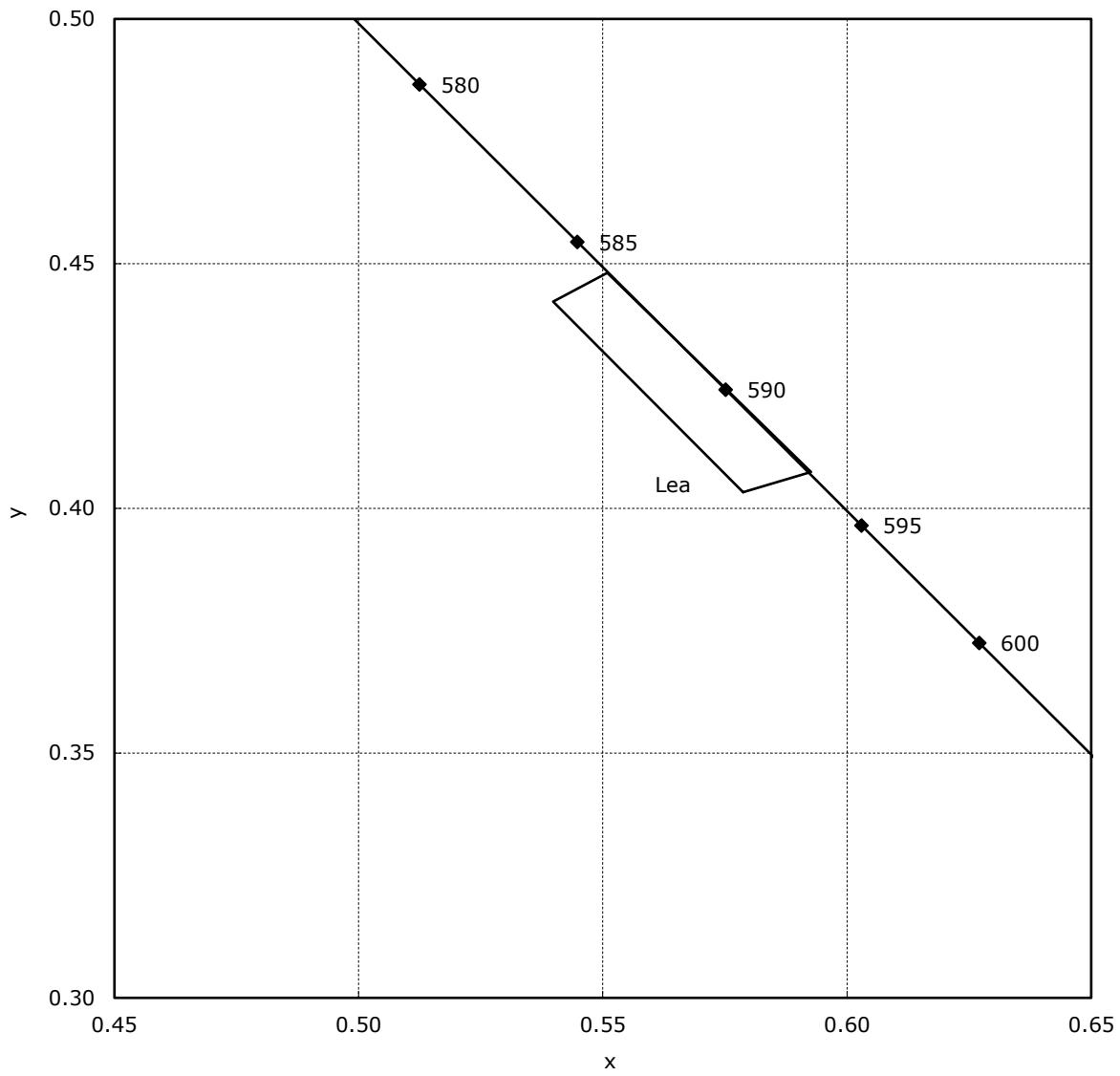

OUTLINE DIMENSIONS

* 本製品はRoHS指令に適合しております。
This product complies with RoHS Directive.

Part No. NCSxE17A-V1
No. STS-DA7-19431

* 括弧で囲まれた寸法は参考値です。
The dimension(s) in parentheses are for reference purposes.

(単位 Unit: mm, 公差 Tolerance: ±0.1)

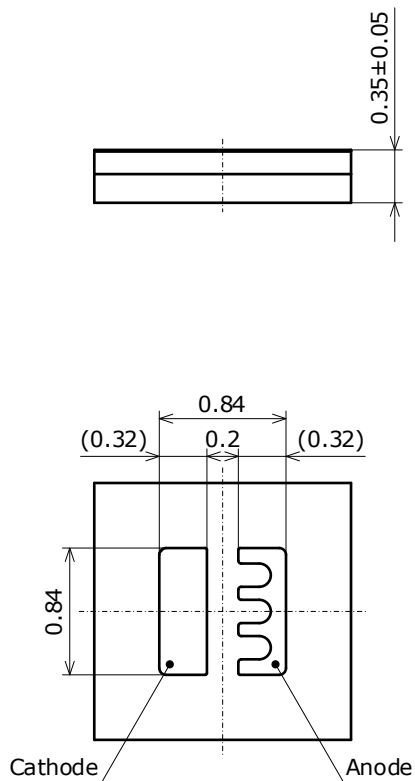
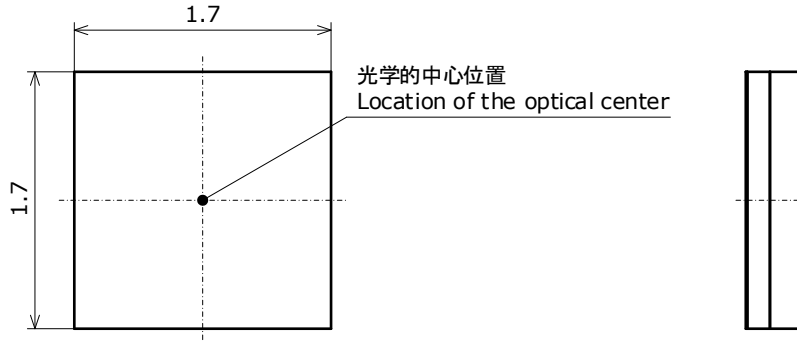

項目 Item	内容 Description
パッケージ材質 Package Materials	シリコン樹脂 Silicone Resin
蛍光体層材質 Phosphor sheet Materials	シリコン樹脂 (拡散剤+蛍光体入り) Silicone Resin (with diffuser and phosphor)
電極材質 Electrodes Materials	金メッキ Au-plated
質量 Weight	0.0026g(TYP)

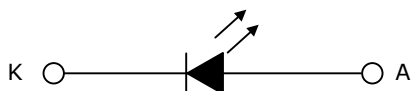

SOLDERING

- Reflow Soldering Condition(Lead-free Solder)

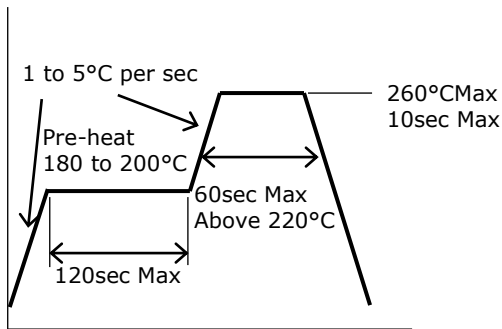

- Recommended Soldering Pad Pattern

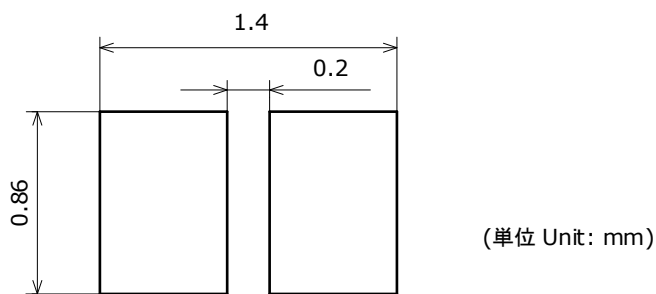

- * This LED is designed to be reflow soldered to a PCB. If dip soldered or hand soldered, Nichia will not guarantee its reliability.
- * Reflow soldering must not be performed more than twice.
- * When cooling the LEDs from the peak temperature a gradual cooling slope is recommended; do not cool the LEDs rapidly.
- * During reflow soldering, the heat and atmosphere in the reflow oven may cause the optical characteristics to degrade. In particular, reflow soldering performed with an air atmosphere may have a greater negative effect on the optical characteristics than if a nitrogen atmosphere is used; Nichia recommends using a nitrogen reflow atmosphere.
- * This LED uses a silicone resin for the encapsulating resin; the silicone resin is soft. If pressure is applied to the silicone resin, it may cause the resin to be damaged, chipped, delaminated and/or deformed. If the resin is damaged, chipped, delaminated and/or deformed, it may cause the internal connection to fail causing a catastrophic failure (i.e. the LED not to illuminate) and/or reliability issues (e.g. the LED to corrode and/or to become dimmer, the color/directivity to change, etc.). Ensure that pressure is not applied to the encapsulating resin.
- * Once the LEDs have been soldered to a PCB, it should not be repaired/reworked.
- * When soldering, do not apply stress to the LED while the LED is hot.
- * When using an automatic pick-and-place machine, choose an appropriate nozzle for this LED.
- * The soldering pad pattern above is a general recommendation for LEDs to be mounted without issues; if a high degree of precision is required for the chosen application (i.e. high-density mounting), ensure that the soldering pad pattern is optimized.
- * When flux is used, it should be a halogen free flux. Ensure that the manufacturing process is not designed in a manner where the flux will come in contact with the LEDs.
- * Ensure that there are no issues with the type and amount of solder that is being used.
- * This LED has all the electrodes on the backside; solder connections will not be able to be seen nor confirmed by a normal visual inspection. Ensure that sufficient verification is performed on the soldering conditions prior to use to ensure that there are no issues.

TAPE AND REEL DIMENSIONS

テーピング部 Tape

NxxxE17x
 管理番号 No. STS-DA7-13882
 (単位 Unit: mm)

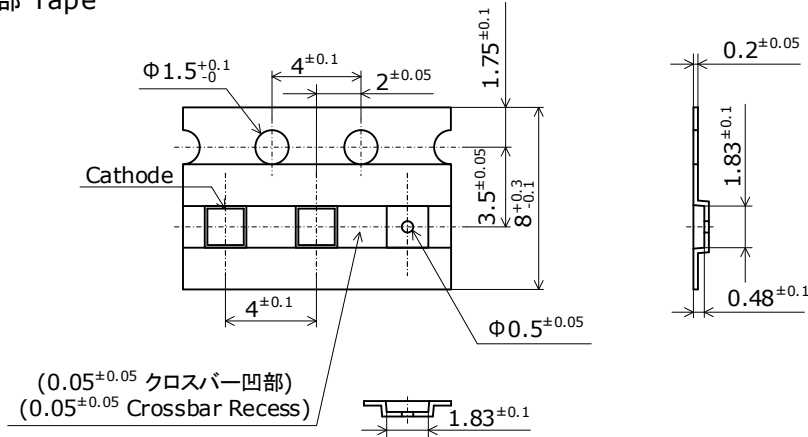

トレーラ部/リーダ部 Trailer and Leader

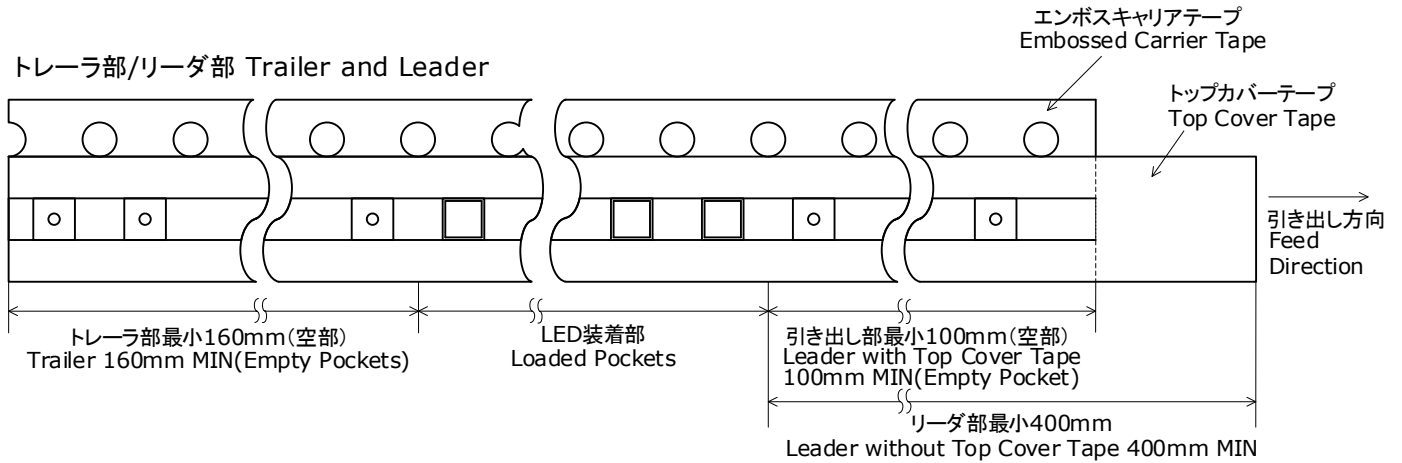

リール部 Reel

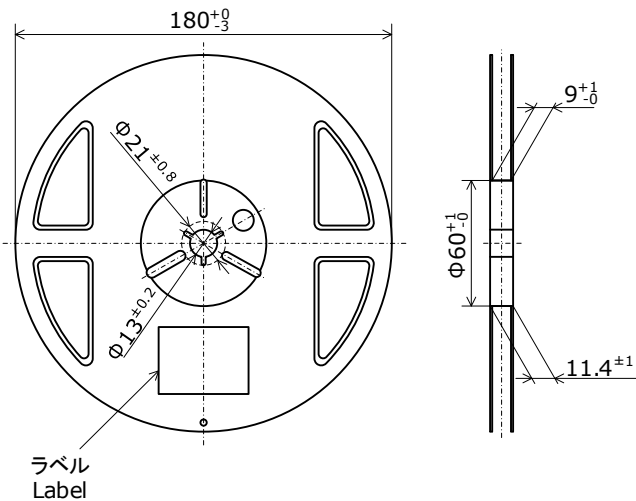

- * 数量は1リールにつき 6000個入りです。
 Reel Size: 6000pcs
- * 実装作業の中断などでエンボスキャリアテープをリールに巻き取る場合、エンボスキャリアテープを強く(10N以上)締めないで下さい。LEDがカバーテープに貼り付く可能性があります。
 When the tape is rewound due to work interruptions, no more than 10N should be applied to the embossed carrier tape. The LEDs may stick to the top cover tape.
- * JIS C 0806電子部品テーピングに準拠しています。
 The tape packing method complies with JIS C 0806 (Packaging of Electronic Components on Continuous Tapes).

PACKAGING - TAPE & REEL

Reels are shipped with desiccants in heat-sealed moisture-proof bags.
シリカゲルとともにリールをアルミ防湿袋に入れ、熱シールにより封をします。

Part No. Nxxxxxxx
No. STS-DA7-4989C

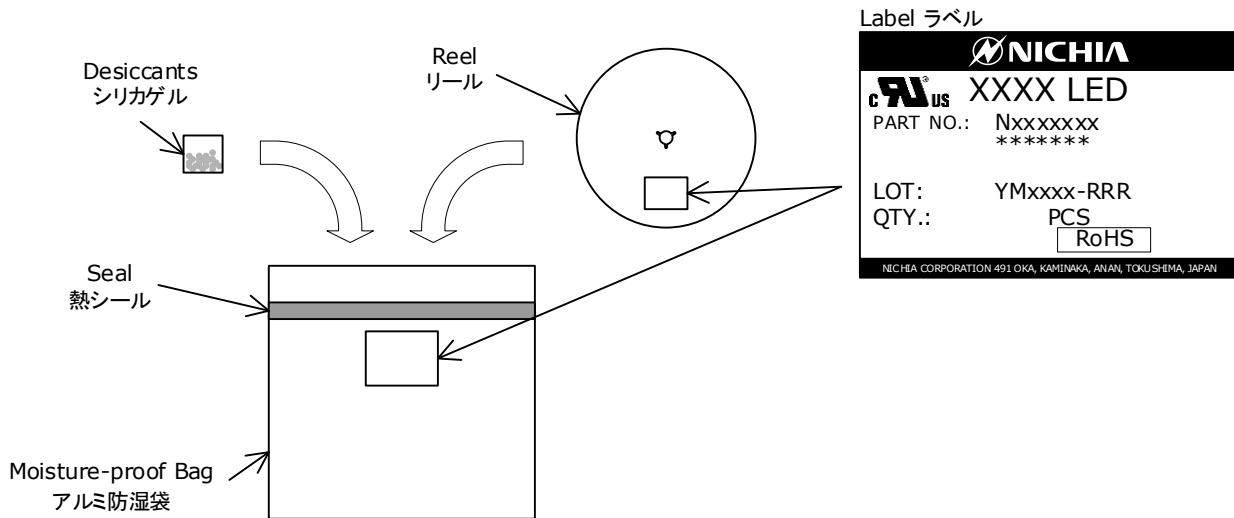

Moisture-proof bags are packed in cardboard boxes with corrugated partitions.
アルミ防湿袋を並べて入れ、ダンボールで仕切ります。

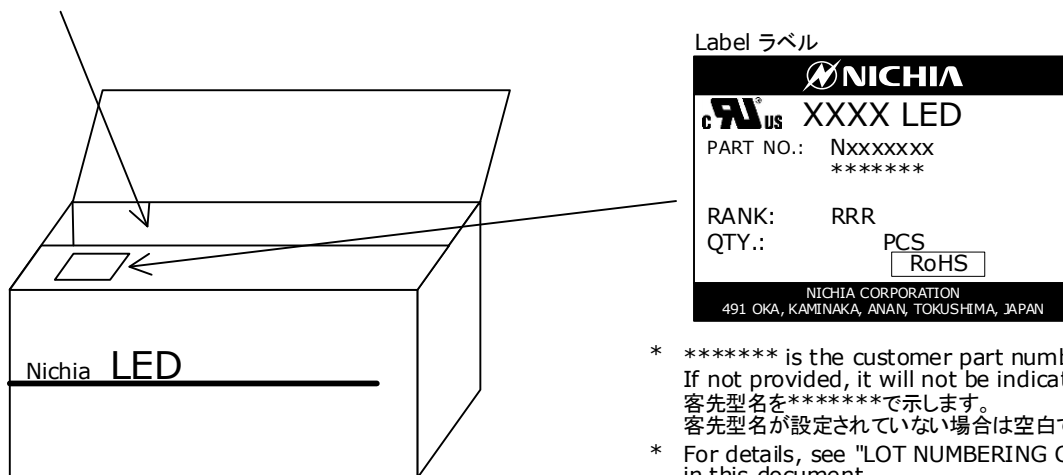

- * ***** is the customer part number. If not provided, it will not be indicated on the label. 客先型名を*****で示します。客先型名が設定されていない場合は空白です。
- * For details, see "LOT NUMBERING CODE" in this document. ロット表記方法についてはロット番号の項を参照して下さい。
- * The label does not have the RANK field for un-ranked products. ランク分けがない場合はランク表記はありません。

- * Products shipped on tape and reel are packed in a moisture-proof bag. They are shipped in cardboard boxes to protect them from external forces during transportation. 本製品はテーピングしたのち、輸送の衝撃から保護するためダンボールで梱包します。
- * Do not drop or expose the box to external forces as it may damage the products. 取り扱いに際して、落下させたり、強い衝撃を与えたりしますと、製品を損傷させる原因になりますので注意して下さい。
- * Do not expose to water. The box is not water-resistant. ダンボールには防水加工がされておりませんので、梱包箱が水に濡れないよう注意して下さい。
- * Using the original package material or equivalent in transit is recommended. 輸送、運搬に際して弊社よりの梱包状態あるいは同等の梱包を行って下さい。

LOT NUMBERING CODE

Lot Number is presented by using the following alphanumeric code.

YMxxxx - RRR

Y - Year

Year	Y
2021	L
2022	M
2023	N
2024	O
2025	P
2026	Q

M - Month

Month	M	Month	M
1	1	7	7
2	2	8	8
3	3	9	9
4	4	10	A
5	5	11	B
6	6	12	C

xxxx-Nichia's Product Number

RRR-Ranking by Color Coordinates, Ranking by Luminous Flux, Ranking by Forward Voltage

DERATING CHARACTERISTICS

Part No. NCSxE17Ax
No. STS-DA7-18316A

**Ambient Temperature vs
Allowable Forward Current**
周囲温度-許容順電流特性

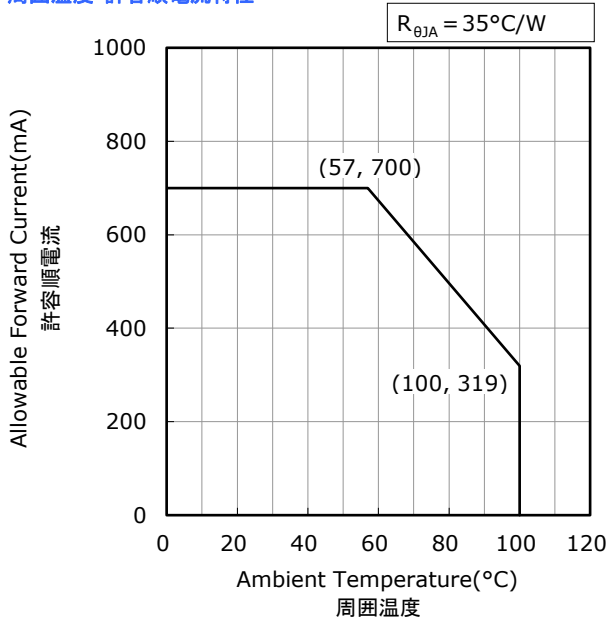

**Temperature at Measurement Point on a Case vs
Allowable Forward Current**
ケース温度測定部温度-許容順電流特性

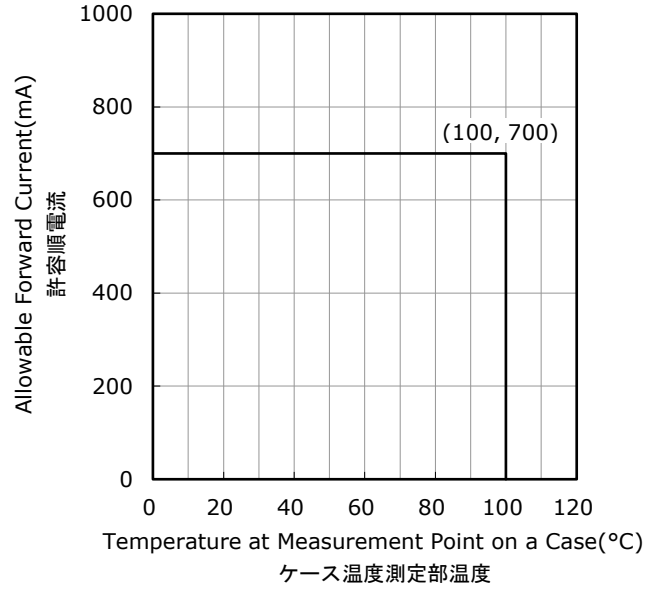

**Duty Ratio vs
Allowable Forward Current**
デューティー比-許容順電流特性

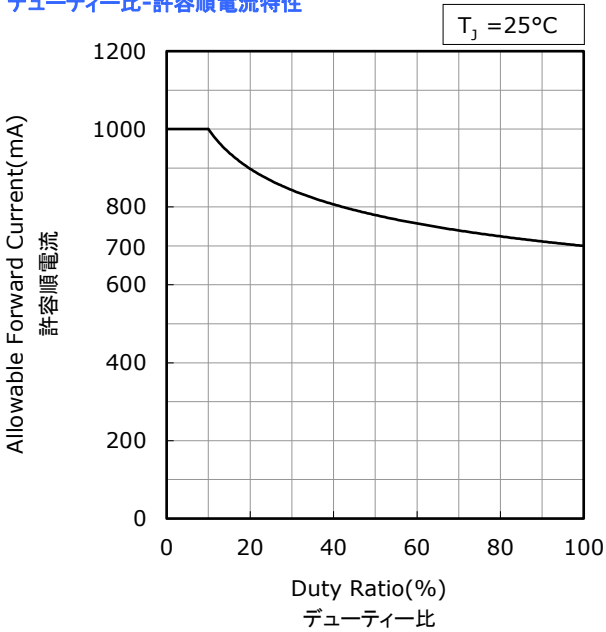

OPTICAL CHARACTERISTICS

- * All characteristics shown are for reference only and are not guaranteed.
本特性は参考です。
- * The following graphs show the characteristics measured in pulse mode.
パルス駆動により測定しています。

Part No. NCSAE17A-V1
No. STS-DA7-19432

Spectrum 発光スペクトル

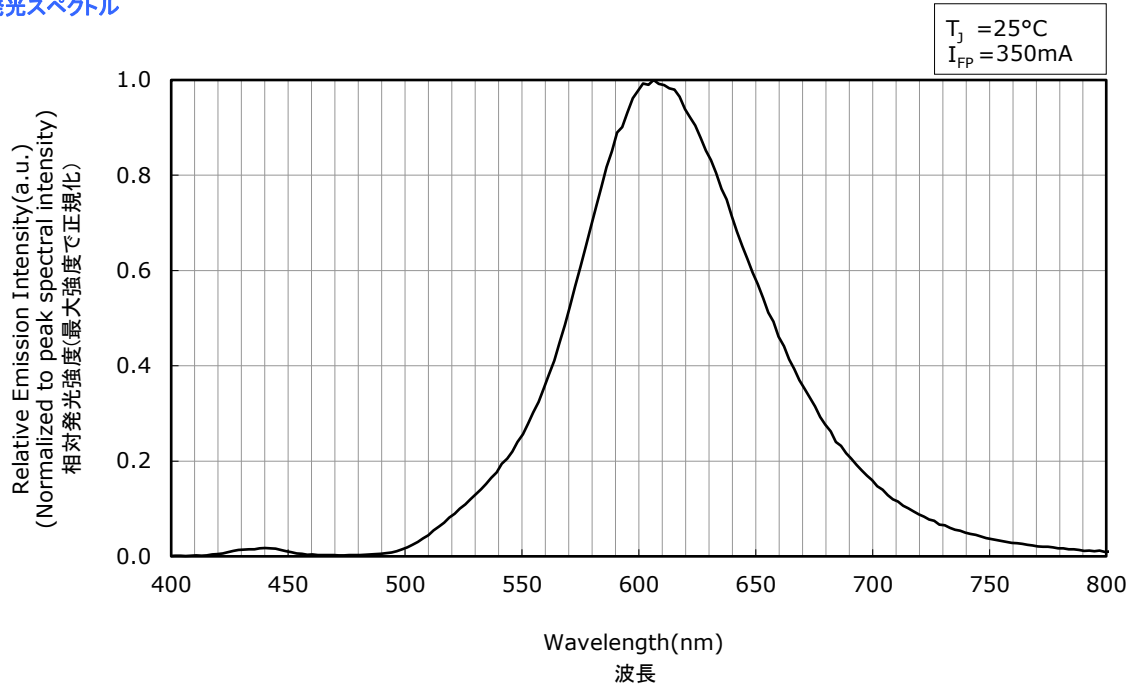

Directivity 指向特性

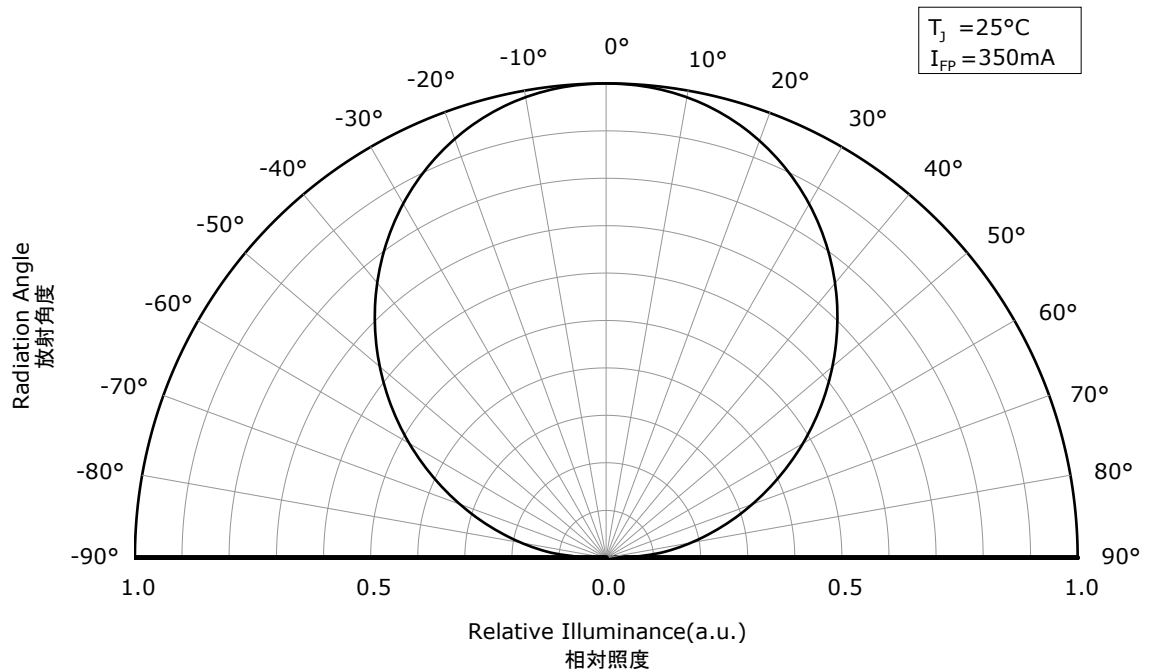

FORWARD CURRENT CHARACTERISTICS / TEMPERATURE CHARACTERISTICS

- * All characteristics shown are for reference only and are not guaranteed.
本特性は参考です。
- * The following graphs show the characteristics measured in pulse mode.
パルス駆動により測定しています。

Part No. NCSAE17A-V1
No. STS-DA7-19433

Forward Voltage vs Forward Current
順電圧-順電流特性

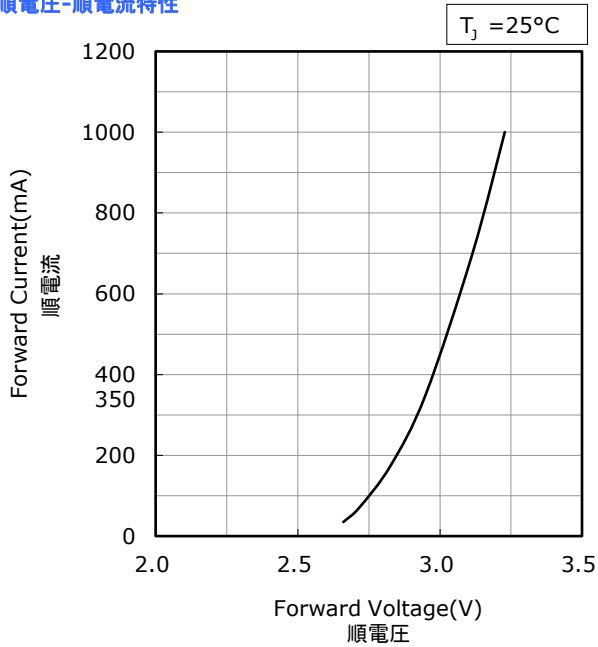

Junction Temperature vs Forward Voltage
ジャンクション温度-順電圧特性

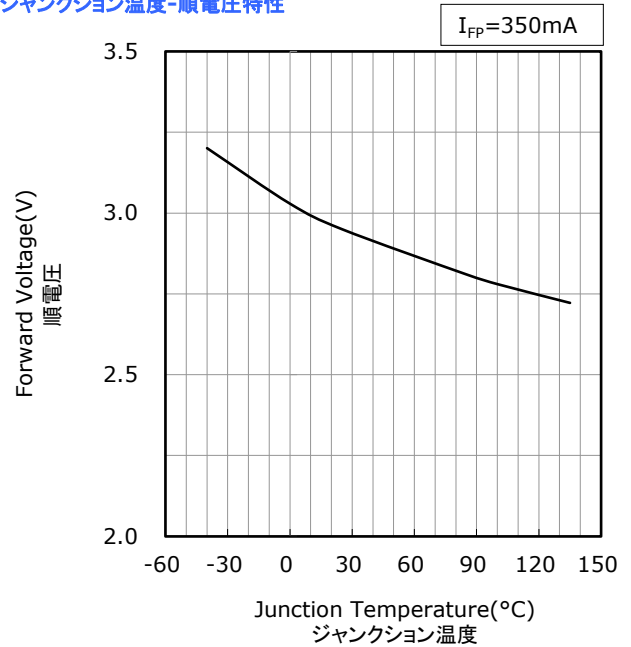

Forward Current vs Relative Luminous Flux
順電流-相対光束特性

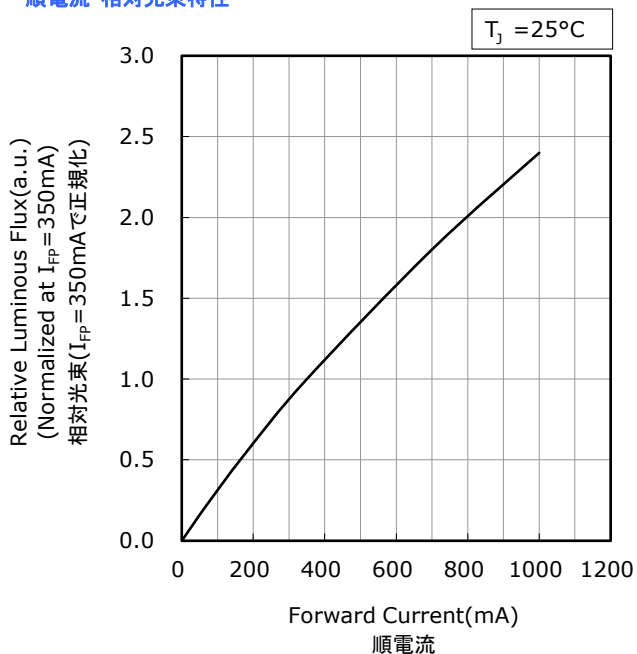

Junction Temperature vs Relative Luminous Flux
ジャンクション温度-相対光束特性

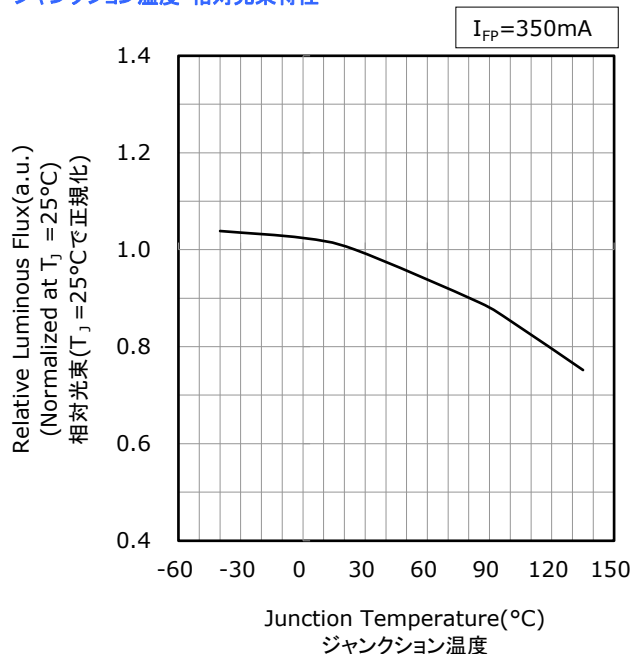

FORWARD CURRENT CHARACTERISTICS / TEMPERATURE CHARACTERISTICS

- * All characteristics shown are for reference only and are not guaranteed.
本特性は参考です。
- * The following graphs show the characteristics measured in pulse mode.
パルス駆動により測定しています。

Part No. NCSAE17A-V1
No. STS-DA7-19434

Forward Current vs Chromaticity Coordinate
順電流-色度 特性

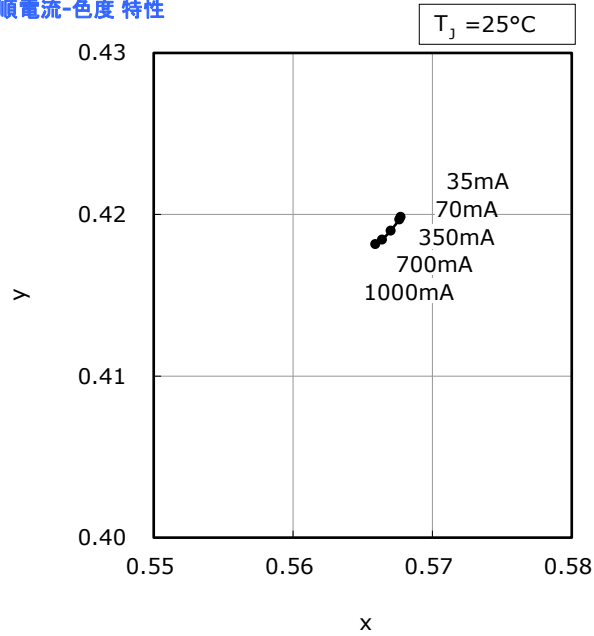

Junction Temperature vs Chromaticity Coordinate
ジャンクション温度-色度 特性

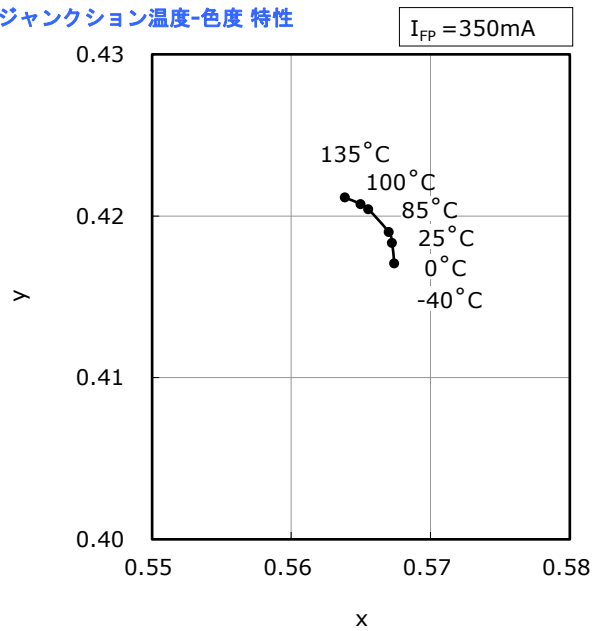

RELIABILITY

(1) Tests and Results

Test	Reference Standard	Test Conditions	Test Duration	Failure Criteria #	Units Failed/Tested
Resistance to Soldering Heat (Reflow Soldering)	JEITA ED-4701 300 301	$T_{\text{slid}}=260^{\circ}\text{C}$, 10sec, 2reflows, Precondition: 30°C , 70%RH, 4weeks		#1	0/22
Solderability	JEITA ED-4701 303 303A	$T_{\text{slid}}=245\pm 5^{\circ}\text{C}$, 5sec, Lead-free Solder(Sn-3.0Ag-0.5Cu)		#2	0/22
Thermal Shock(Air to Air)		-40°C to 100°C , 15min dwell	100cycles	#1	0/22
Moisture Resistance (Cyclic)	JEITA ED-4701 200 203	$25^{\circ}\text{C}\sim 65^{\circ}\text{C}\sim -10^{\circ}\text{C}$, 90%RH, 24hr per cycle	10cycles	#1	0/22
High Temperature Storage	JEITA ED-4701 200 201	$T_{\text{A}}=100^{\circ}\text{C}$	1000hours	#1	0/22
Temperature Humidity Storage	JEITA ED-4701 100 103	$T_{\text{A}}=60^{\circ}\text{C}$, RH=90%	1000hours	#1	0/22
Low Temperature Storage	JEITA ED-4701 200 202	$T_{\text{A}}=-40^{\circ}\text{C}$	1000hours	#1	0/22
Room Temperature Operating Life		$T_{\text{A}}=25^{\circ}\text{C}$, $I_{\text{F}}=700\text{mA}$ Test board: See NOTES below	1000hours	#1	0/22
High Temperature Operating Life		$T_{\text{A}}=100^{\circ}\text{C}$, $I_{\text{F}}=300\text{mA}$ Test board: See NOTES below	1000hours	#1	0/22
Temperature Humidity Operating Life		60°C , RH=90%, $I_{\text{F}}=650\text{mA}$ Test board: See NOTES below	500hours	#1	0/22
Low Temperature Operating Life		$T_{\text{A}}=-40^{\circ}\text{C}$, $I_{\text{F}}=700\text{mA}$ Test board: See NOTES below	1000hours	#1	0/22
Vibration	JEITA ED-4701 400 403	200m/s^2 , 100~2000~100Hz, 4cycles, 4min, each X, Y, Z	48minutes	#1	0/22
Free Fall		3drops from a height of 75cm		#1	0/22

NOTES:

- 1) Test board: FR4 board thickness=1.6mm, copper layer thickness=35 μm , $R_{\theta\text{JA}}\approx 35^{\circ}\text{C/W}$
- 2) Measurements are performed after allowing the LEDs to return to room temperature.

(2) Failure Criteria

Criteria #	Items	Conditions	Failure Criteria
#1	Forward Voltage(V_{F})	$I_{\text{F}}=350\text{mA}$	>U.S.L. $\times 1.1$
	Luminous Flux(Φ_{v})	$I_{\text{F}}=350\text{mA}$	<L.S.L. $\times 0.7$
	Reverse Current(I_{R})	$V_{\text{R}}=5\text{V}$	>U.S.L. $\times 2.0$
#2	Solderability	-	Less than 95% solder coverage

U.S.L. : Upper Specification Limit L.S.L. : Lower Specification Limit

CAUTIONS

(1) Storage

Conditions		Temperature	Humidity	Time
Storage	Before Opening Aluminum Bag	$\leq 30^{\circ}\text{C}$	$\leq 90\% \text{RH}$	Within 1 Year from Delivery Date
	After Opening Aluminum Bag	$\leq 30^{\circ}\text{C}$	$\leq 70\% \text{RH}$	≤ 4 weeks

- The storage/packaging requirements for this LED are comparable to JEDEC Moisture Sensitivity Level (MSL) 2a or equivalent. Nichia used IPC/JEDEC STD-020 as a reference to rate the MSL of this LED.
- Ensure that soldering is completed within the storage times detailed above.
- This LED uses a package that could absorb moisture; if the package absorbs moisture and is exposed to heat during soldering, it may cause the moisture to vaporize and the package to expand and the resulting pressure may cause internal delamination. This may cause the optical characteristics to degrade. To minimize moisture absorption in storage/transit, moisture-proof aluminum bags are used for the LEDs with a silica gel packet to absorb any air moisture in the bag. The silica gel beads turn blue to red as they absorb moisture.
- Once the moisture-proof aluminum bag is open, ensure that the LED is soldered to a PCB within the range of the conditions above. To store any remaining unused LEDs, use a hermetically sealed container with silica gel desiccants. Nichia recommends placing them back to the original moisture-proof bag and reseal it.
- This LED has gold-plated electrodes. If the LEDs are exposed to a corrosive environment, it may cause the plated surface to tarnish causing issues (i.e. solderability). Ensure that when storing LEDs, a hermetically sealed container is used. Nichia recommends placing them back to the original moisture-proof bag and reseal it.
- To prevent substances/gases from affecting the plated surface, ensure that the parts/materials used with the LEDs in the same assembly/system do not contain sulfur (e.g. gasket/seal, adhesive, etc.). If the plating is contaminated, it may cause issues (e.g. electric connection failures). If a gasket/seal is used, silicone rubber gaskets/seals are recommended; ensure that this use of silicone does not result in issues (e.g. electrical connection failures) caused by low molecular weight volatile siloxane.
- To avoid condensation, the LEDs must not be stored in areas where temperature and humidity fluctuate greatly.
- Do not store the LEDs in a dusty environment.
- Do not expose the LEDs to direct sunlight and/or an environment over a long period of time where the temperature is higher than normal room temperature.

(2) Directions for Use

- The circuit must be designed to ensure that the Absolute Maximum Ratings are not exceeded for each LED. The LEDs should be operated at a constant current per LED. In the case of operating at a constant voltage, Circuit B is recommended. If Circuit A is used, it may cause the currents flowing through the LEDs to vary due to the variation in the forward voltage characteristics of the LEDs on the circuit.

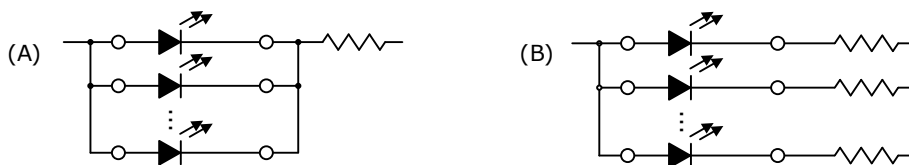

- This LED is designed to be operated at a forward current. Ensure that no voltage is applied to the LED in the forward/reverse direction while the LED is off. If the LEDs are used in an environment where reverse voltages are applied to the LED continuously, it may cause electrochemical migration to occur causing the LED to be damaged. When not in use for a long period of time, the system's power should be turned off to ensure that there are no issues/damage.
- To stabilize the LED characteristics while in use, Nichia recommends that the LEDs are operated at currents $\geq 10\%$ of the sorting current.
- If LEDs are arranged into rows and columns in a grid circuit (i.e. LED matrix circuit) and operated, ensure that when using a pulsed mode to operate the LEDs in a matrix circuit, the reverse voltage for any of the LEDs does not exceed the Absolute Maximum Rating while the LED is off.
- Ensure that transient excessive voltages (e.g. lightning surge) are not applied to the LEDs.
- If the LEDs are used for outdoor applications, ensure that necessary measures are taken (e.g. protecting the LEDs from water/salt damage and high humidity).

(3) Handling Precautions





- Do not handle the LEDs with bare hands as it will contaminate the LED surface and may affect the optical characteristics: it might cause the LED to be deformed and/or the bump to break, which will cause the LED not to illuminate.
- This LED uses a silicone resin for the encapsulating resin; the silicone is very soft. If an object (e.g. hand, nozzle, tweezers, etc.) comes in contact with the surface of the encapsulating resin when handling an LED, it may cause damage to the encapsulating resin surface (e.g. cut, scratch, chip, crack, delamination, and deformation). If force is applied to the encapsulating resin, it may cause the internal connection to fail causing a catastrophic failure (i.e. the LED not to illuminate). Ensure that when handling LEDs, the encapsulating resin does not have contact with any object that may cause this damage (e.g. hand, tweezers, pick-and-place nozzle, etc.) and is not exposed to excessive force.
- Dropping may cause damage to the LED (e.g. deformation).
- Do not stack assembled PCBs together. Otherwise, it may cause damage to the resin (e.g. cut, scratch, chip, crack, delamination and deformation) and the internal connection to fail causing a catastrophic failure (i.e. the LED not to illuminate).

(4) Design Consideration

- If the LEDs are soldered to a PCB and the PCB assembly is bent (e.g. PCB depaneling process), it may cause the LED package to break. The PCB layout should be designed to minimize the mechanical stress on the LEDs when the PCB assembly is bent/warped.
- The amount of mechanical stress exerted on the LED from depaneling may vary depending on the LED position/orientation on the PCB assembly (e.g. especially in areas near V-groove scores). The PCB layout should be designed to minimize the mechanical stress on the LEDs when the PCB is separated into individual PCB assemblies.
- To separate a PCB populated with the LEDs, use a specially designed tool. Do not break the PCB by hand.
- Volatile organic compounds that have been released from materials present around the LEDs (e.g. housing, gasket/seal, adhesive, secondary lens, lens cover, grease, etc.) may penetrate the LED emitting surface. If the LEDs are being used in a hermetically/near-hermetically sealed environment, these volatile compounds can discolor after being exposed to heat and/or photon energy and it may greatly reduce the LED light output and/or color shift. In this case, ventilating the environment may improve the reduction in light output and/or color shift. Perform a light-up test of the chosen application for optical evaluation prior to use to ensure that there are no issues, this test should be performed taking into consideration the conditions/environments in which the end-product containing these LEDs will actually be used.
- The characteristics of the LEDs (e.g. chromaticity, etc.) will vary depending on how the LEDs are designed into the application (e.g. secondary lens, luminaire cover/housing, etc. for ease of dissipation), how they were assembled, under what conditions/environments they are used (e.g. operating current/temperature, etc.), and how long they have been used (e.g. storage/operating hours, etc.). To ensure that there are no issues (e.g. deviations/changes in the characteristics, etc.) with the chosen application, perform a sufficient verification prior to use.
- Ensure that the chosen soldering pad pattern has a solder mask which does not cover the copper pads that the LED will be attached to or the area underneath the LED.

(Non Solder Mask Defined [NSMD] pads are recommended; see the figure below.)

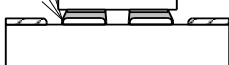
Refer to the relevant application notes. To access the application notes, go to the Technical Suggestions And Recommendations section of Nichia’s website.

	NSMD(推奨 Recommended)	SMD(参考 Reference)
製品実装前 Before Mounting the LED	<p>ソルダーレジスト 銅箔パッド Solder Mask Copper Pad</p>  <p>基材 Base Material</p>	<p>ソルダーレジスト 銅箔パッド Solder Mask Copper Pad</p>  <p>基材 Base Material</p>
製品実装後 After Mounting the LED	<p>はんだペースト 製品 LED Solder Paste 製品 LED</p> 	<p>はんだペースト 製品 LED Solder Paste 製品 LED</p> 

(5) Electrostatic Discharge (ESD)

- This LED is sensitive to transient excessive voltages (e.g. ESD, lightning surge). If this excessive voltage occurs in the circuit, it may cause the LED to be damaged causing issues (e.g. the LED to become dimmer or not to illuminate [i.e. catastrophic failure]). Ensure that when handling the LEDs, necessary measures are taken to protect them from an ESD discharge. The following examples are recommended measures to eliminate the charge:
 - Grounded wrist strap, ESD footwear, clothes, and floors
 - Grounded workstation equipment and tools
 - ESD table/shelf mat made of conductive materials
- Ensure that all necessary measures are taken to prevent the LEDs from being exposed to transient excessive voltages (e.g. ESD, lightning surge):
 - tools, jigs, and machines that are used are properly grounded
 - appropriate ESD materials/equipment are used in the work area
 - the system/assembly is designed to provide ESD protection for the LEDs
- If the tool/equipment used is an insulator (e.g. glass cover, plastic, etc.), ensure that necessary measures have been taken to protect the LED from transient excessive voltages (e.g. ESD). The following examples are recommended measures to eliminate the charge:
 - Dissipating static charge with conductive materials
 - Preventing charge generation with moisture
 - Neutralizing the charge with ionizers
- To detect if an LED was damaged by transient excess voltages (i.e. an ESD event during the system's assembly process), perform a characteristics inspection (e.g. forward voltage measurement, light-up test) at low current ($\leq 1\text{mA}$).
- Failure Criteria: $V_F < 2.0\text{V}$ at $I_F = 0.5\text{mA}$
 If any one or more dice, except for the red die, are damaged by transient excess voltages (e.g. ESD), it will cause:
 - the leakage current to increase
 - the Forward Voltage (V_F) to decrease
 - the LED not to illuminate at a low current

(6) Thermal Management

- The Absolute Maximum Junction Temperature (T_J) must not be exceeded under any circumstances. The increase in the temperature of an LED while in operation may vary depending on the PCB thermal resistance and the density of LEDs on the PCB assembly. Ensure that when using the LEDs for the chosen application, heat is not concentrated in an area and properly managed in the system/assembly.
- The operating current should be determined by considering the temperature conditions surrounding the LED (i.e. T_A). Ensure that when operating the LED, proper measures are taken to dissipate the heat.
- The following two equations can be used to calculate the LED junction temperature:
 - 1) $T_J = T_A + R_{\theta JA} \cdot W$
 - 2) $T_J = T_C + R_{\theta JC} \cdot W$
 - * T_J =LED Junction Temperature: °C
 - T_A =Ambient Temperature: °C
 - T_C =Case Temperature: °C
 - $R_{\theta JA}$ =Thermal Resistance from Junction to Ambient: °C/W
 - $R_{\theta JC}$ =Thermal Resistance from Junction to T_C Measurement Point: °C/W
 - W =Input Power($I_F \times V_F$): W

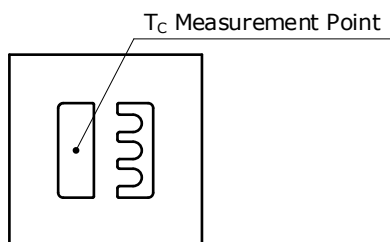

- Once the LEDs have been soldered to a PCB, it is difficult to measure T_C due to the location of the T_C measurement point. **Refer to the relevant application notes for other methods of determining the T_J . To access the application notes, go to the Technical Suggestions And Recommendations section of Nichia's website.**

(7) Cleaning

- Do not clean the LEDs with water, benzine and/or thinner.
- To clean the LEDs, use isopropyl alcohol (IPA). If another solvent is used, it may cause the LED package/resin to be damaged causing issues; ensure that sufficient verification is performed prior to use. Additionally, ensure that the solvent being used does not cause any other issues (e.g. CFC-based solvents are heavily regulated).
- If an LED is contaminated (e.g. dust/dirt), use a cloth soaked with isopropyl alcohol (IPA). Ensure that the cloth is firmly squeezed before wiping the LED.
- Do not clean the LEDs with an ultrasonic cleaner. If cleaning must be done, ensure that sufficient verification is performed by using a finished assembly with LEDs to determine cleaning conditions (e.g. ultrasonic power, LED position on the PCB assembly) that do not cause an issue.

(8) Eye Safety

- There may be two important international specifications that should be noted for safe use of the LEDs: IEC 62471:2006 Photobiological safety of lamps and lamp systems and IEC 60825-1:2001 (i.e. Edition 1.2) Safety of Laser Products - Part 1: Equipment Classification and Requirements. Ensure that when using the LEDs, there are no issues with the following points:
 - LEDs have been removed from the scope of IEC 60825-1 since IEC 60825-1:2007 (i.e. Edition 2.0) was published. However, depending on the country/region, there are cases where the requirements of the IEC 60825-1:2001 specifications or equivalent must be adhered to.
 - LEDs have been included in the scope of IEC 62471:2006 since the release of the specification in 2006.
 - Most Nichia LEDs will be classified as the Exempt Group or Risk Group 1 according to IEC 62471:2006. However, in the case of high-power LEDs containing blue wavelengths in the emission spectrum, there are LEDs that will be classified as Risk Group 2 depending on the characteristics (e.g. radiation flux, emission spectrum, directivity, etc.)
 - If the LED is used in a manner that produces an increased output or with an optic to collimate the light from the LED, it may cause damage to the human eye.
- If an LED is operated in a manner that emits a flashing light, it may cause health issues (e.g. visual stimuli causing eye discomfort). The system should be designed to ensure that there are no harmful effects on the human body.

(9) Miscellaneous

- Nichia warrants that the discrete LEDs will meet the requirements/criteria as detailed in the Reliability section within this specification. If the LEDs are used under conditions/environments deviating from or inconsistent with those described in this specification, the resulting damage and/or injuries will not be covered by this warranty.
- Nichia warrants that the discrete LEDs manufactured and/or supplied by Nichia will meet the requirements/criteria as detailed in the Reliability section within this specification; it is the customer's responsibility to perform sufficient verification prior to use to ensure that the lifetime and other quality characteristics required for the intended use are met.
- The applicable warranty period is one year from the date that the LED is delivered. In the case of any incident that appears to be in breach of this warranty, the local Nichia sales representative should be notified to discuss instructions on how to proceed while ensuring that the LED in question is not disassembled or removed from the PCB if it has been attached to the PCB. If a breach of this warranty is proved, Nichia will provide the replacement for the non-conforming LED or an equivalent item at Nichia's discretion. FOREGOING ARE THE EXCLUSIVE REMEDIES AVAILABLE TO THE CUSTOMER IN RESPECT OF THE BREACH OF THE WARRANTY CONTAINED HEREIN, AND IN NO EVENT SHALL NICHIA BE RESPONSIBLE FOR ANY INDIRECT, INCIDENTAL OR CONSEQUENTIAL LOSSES AND/OR EXPENSES (INCLUDING LOSS OF PROFIT) THAT MAY BE SUFFERED BY THE CUSTOMER ARISING OUT OF A BREACH OF THE WARRANTY.
- NICHIA DISCLAIMS ALL OTHER WARRANTIES, EXPRESS OR IMPLIED, INCLUDING THE IMPLIED WARRANTIES OF MERCHANTABILITY AND FITNESS FOR A PARTICULAR PURPOSE.
- This LED is intended to be used for general lighting, household appliances, electronic devices (e.g. mobile communication devices); it is not designed or manufactured for use in applications that require safety critical functions (e.g. aircraft, automobiles, combustion equipment, life support systems, nuclear reactor control system, safety devices, spacecraft, submarine repeaters, traffic control equipment, trains, vessels, etc.). If the LEDs are planned to be used for these applications, unless otherwise detailed in the specification, Nichia will neither guarantee that the LED is fit for that purpose nor be responsible for any resulting property damage, injuries and/or loss of life/health. This LED does not comply with IATF 16949 and is not intended for automotive applications.
- The customer will not reverse engineer, disassemble or otherwise attempt to extract knowledge/design information from the LED.
- All copyrights and other intellectual property rights in this specification in any form are reserved by Nichia or the right holders who have granted Nichia permission to use the content. Without prior written permission from Nichia, no part of this specification may be reproduced in any form or by any means.
- Both the customer and Nichia will agree on the official specifications for the supplied LEDs before any programs are officially launched. Without this agreement in writing (i.e. Customer Specific Specification), changes to the content of this specification may occur without notice (e.g. changes to the foregoing specifications and appearance, discontinuation of the LEDs, etc.).